

SECURITY

PRODUCT CATALOG

Jan.2024
www.optex.co.jp/e





SECURITY

Creating a safe and
comfortable world with
sensing technology.

Sensing Innovation.

In recent years, violent attacks of terrorism and crime, information leakage by internal stakeholders, etc. have become a social problem, and the security measures of facilities are very important themes.

OPTEX proposes to construct an optimum security system for every field by combining our intrusion detectors and access control systems.

We are aiming to provide safe, secure and comfortable living with high precision and reliable sensing technology recognized in the world.

Application examples



Perimeter protection X Laser scan / Photoelectric detectors

Intrusion detection for solar power plant

Power cables of solar power plants are tend to be stolen by metal thefts and perimeter protections are very effective.



Perimeter protection X Laser scan / Outdoor PIR detectors

Intrusion detection for power plant / substation

Optex's detectors are suitable for power plant / substation requiring high security level.



Automatic tracking X Laser scan / Outdoor PIR detectors

PTZ camera control

Detectors can output detection signals to a control panel and which helps to move control PTZ cameras' preset position.



Wall protection X Laser scan detectors

Art protection

Form of detection area by laser scan detectors can be easily changed by your PC with dedicated software.

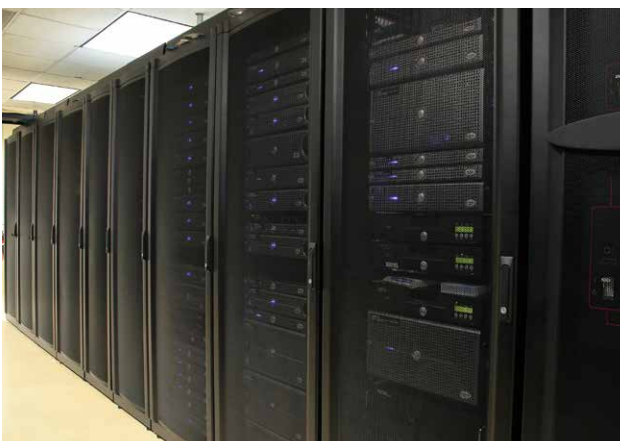

Access control X Anti-tailgating

Anti-tailgating for data center

The access control system which prevents unauthorized persons tailgating at gates and doors makes security level higher at data center.



Access control X Reverse detection

Reverse detection for airport

Pedestrians who walk backward at one-way area in airport can be detected.

CONCEPT FOR LEVEL SURVEILLANCE [KEY POINT TO ACHIEVE ADVANCED SECURITY]

When a general-purpose mechanical security system is installed, detectors are located inside a building and a monitoring station is notified if an intruder is detected within.

In order to increase the effectiveness of such a security system, Optex recommends not only securing the inside of the building but also adding surveillance to the perimeter area and boundary of the property. Optex has developed a system of enhanced outdoor surveillance that is capable of forestalling unauthorized entry into a building. By integrating outdoor and indoor surveillance, this system creates a defense line incorporating three warning levels targeting the perimeter of the property, the boundary of the building, and the indoor area. As a result, we can greatly strengthen and improve crime prevention.

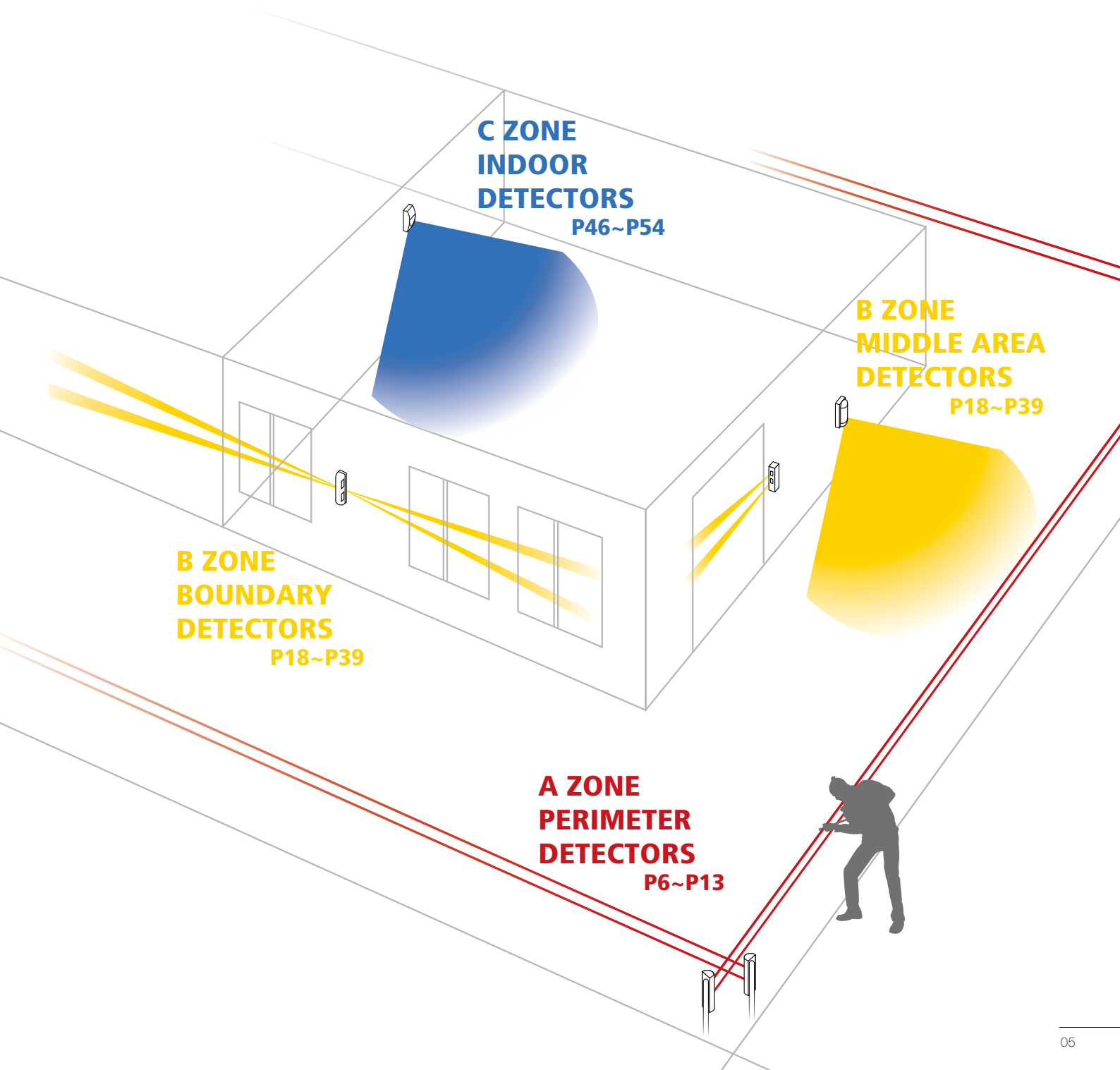

SL-200QDM/350QDM/650QDM

A-ZONE

ADVANCED LONG RANGE PHOTOELECTRIC DETECTOR

Smart Line™ series



SL-200QDM/350QDM/650QDM series is the most advanced long range photoelectric detector. In addition to quad beam and double modulation, our unique technology automatic transmit power control decreases false and missed alarms. LED Indicator and sound assist and upper/lower beam selection button lighten your workload while achieving perfect alignment.

- SL-200QDM – detection range 60m
- SL-350QDM – detection range 100m
- SL-650QDM – detection range 200m

FEATURES

- High power quad beam
- Double modulation
- A.T.P.C.-Automatic transmit power control
- I.A.S.C.- Integrated alignment status communication
- Upper/lower beam selection button
- Beam power control selector
- LED indicator and sound assist
- Sniper viewfinder with 2X magnification lens
- International protection IP65

A.T.P.C.-AUTOMATIC TRANSMIT POWER CONTROL

Automatically controls, adjusts and optimizes the power of the beam and maintains optimal performance. It decreases false and missed alarms caused by fog, frost, cross talk, signal saturation.

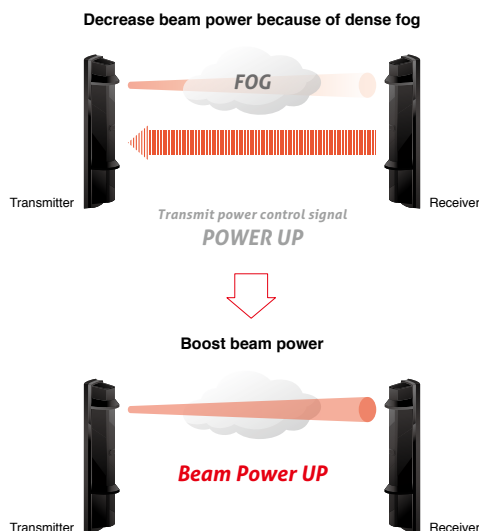

OPTIONS

- ABC-4 : Anti Bird Cap
- BC-4 : Back Cover
- PSC-4 : Pole Side Cover
- BAU-4 : Beam Alignment Unit
- HU-3 : Heating Unit
- CBR-4 : Conduit Bracket

DIMENSIONS

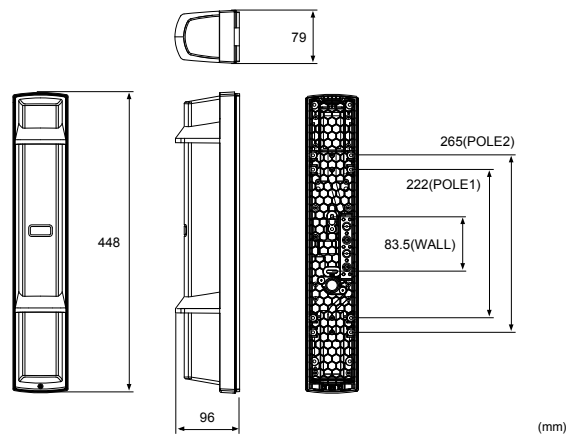

SPECIFICATIONS

Model		SL-200QDM	SL-350QDM	SL-650QDM
Maximum detection range		60m	100m	200m
Maximum arrival distance		600m	1000m	2000m
Detection method		Quad infrared beam interruption detection		
Selectable beam frequency		4 channels		
Interruption period		Variable between 50/100/250/500 ms (4 steps)		
Power source		Normal: 10.5 to 30 VDC		
Current draw (MAX)	Normal	10.5 - 30 VDC	26 mA (T:11 mA, R:15 mA)	30 mA (T:15 mA, R:15 mA)
	Optical alignment	10.5 - 30 VDC	36 mA (T:16 mA, R:20 mA)	43 mA (T:20 mA, R:23 mA)
Output	Alarm output	Form C relay: 30 VDC, 0.2 A		
	Alarm period	2 sec (±1) (Nominal)		
	D.Q. output	Form C relay: 30 VDC, 0.2 A (D.Q. and Low battery can be switched.)		
	Low battery output			
	Tamper output	N.C. (contact output): 30 VDC, 0.1 A Opens when the cover removed.		
Operating temperature		-35 to +60°C		
Operating humidity		95% (max.)		
Alignment angle		±90° Horizontal, ±10° Vertical		
Dimension(H x W x D)		448mm x 79mm x 96mm		
Weight		2500 g (Total weight of the transmitter + receiver, excluding accessories)		
International protection		IP65		

Specifications and design are subject to change without prior notice.

SL-200QDP/350QDP/650QDP

A-ZONE

STANDARD LONG RANGE PHOTOELECTRIC DETECTOR

Smart Line™ series



SL-200QDP/350QDP/650QDP series is standard long range photoelectric detector. In addition to basic feature such as quad beam /double modulation, sunshine protection technology and beam power control selector decreases false and missed alarms. LED Indicator and sound assist(receiver only) and upper/lower beam selection button lighten your workload while achieving perfect alignment.

- SL-200QDP – detection range 60m
- SL-350QDP – detection range 100m
- SL-650QDP – detection range 200m

FEATURES

- High power quad beam
- Double modulation
- Upper/lower beam selection button
- Beam power control selector
- LED indicator and sound assist (receiver only)
- Sniper viewfinder with 2X magnification lens
- International protection IP65

Double Modulation Beam

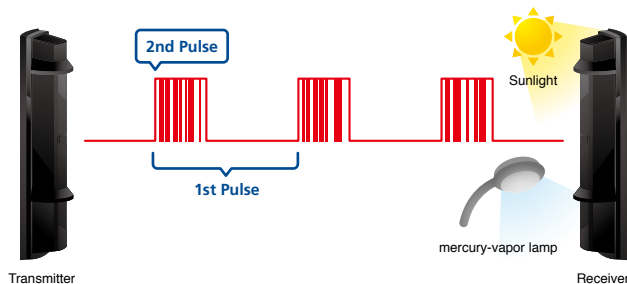

The SL-QDM and SL-QDP offer double modulation beams that differ in pulse patterns. This can enhance signal discrimination against potential noise interference such as sunlight or other external light sources, resulting in a reduction of missed alarms.

Together with OPTEX triple layered sunshine protection technology, it ensures high reliability under the severe outdoor security environment.

OPTIONS

- ABC-4 : Anti Bird Cap
- BC-4 : Back Cover
- PSC-4 : Pole Side Cover
- BAU-4 : Beam Alignment Unit
- HU-3 : Heating Unit
- CBR-4 : Conduit Bracket

DIMENSIONS

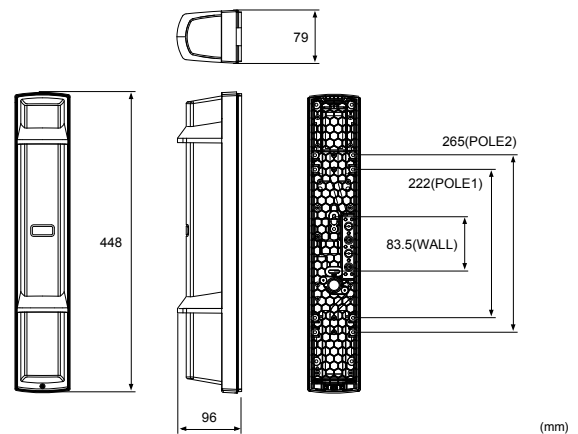

SPECIFICATIONS

Model		SL-200QDP	SL-350QDP	SL-650QDP
Maximum detection range		60m	100m	200m
Maximum arrival distance		600m	1000m	2000m
Detection method		Quad infrared beam interruption detection		
Selectable beam frequency		4 channels		
Interruption period		Variable between 50/100/250/500 ms (4 steps)		
Power source		10.5 to 30 VDC		
Current draw (MAX)	Normal	10.5 - 30 VDC		17 mA (T:6 mA, R:11 mA)
	Optical alignment	10.5 - 30 VDC		21 mA (T:7 mA, R:14 mA)
Output	Alarm output	Form C relay: 30 VDC, 0.2 A		
	Alarm period	2 sec (±1) (Nominal)		
	D.Q. output	Form C relay: 30 VDC, 0.2 A		
	Tamper output	N.C. (contact output): 30 VDC, 0.1 A Opens when the cover removed.		
Operating temperature		-35 to +60°C		
Operating humidity		95% (max.)		
Alignment angle		±90° Horizontal, ±10° Vertical		
Dimension(H x W x D)		448mm x 79mm x 96mm		
Weight		2400 g (Total weight of the transmitter + receiver, excluding accessories)		
International protection		IP65		

Specifications and design are subject to change without prior notice.

OUTDOOR PROTECTION

INDOOR PROTECTION

REDWALL

ACCESS CONTROL

TECHNICAL INFORMATION

SL-200QN/350QN/650QN

A-ZONE

BASIC LONG RANGE PHOTOELECTRIC DETECTOR

Smart Line™ series



SL-200QN/350QN/650QN series is basic long range photoelectric detector. It has IP65 structure and quad beam. Sniper viewfinder and beam alignment unit: BAU-4(option) helps you achieve perfect alignment.

- SL-200QN – detection range 60m
- SL-350QN – detection range 100m
- SL-650QN – detection range 200m

FEATURES

- High power quad beam
- Smart design - slim body
 - vivid interior color
- Sniper viewfinder with 2X magnification lens
- International protection IP65

QUAD BEAM & UNITED APPEARANCE

By employing quad beam, it dramatically reduces false alarm caused by birds and falling leaves. Moreover, it is also important that the housing design of both long and short beams are united. 60m (200ft.) range models, SL-200QN/SL-200QDP/SL-200QDM with a wide beam pitch is now available.

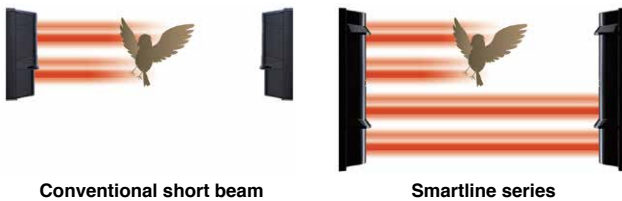

Conventional short beam

Smartline series

DIMENSIONS

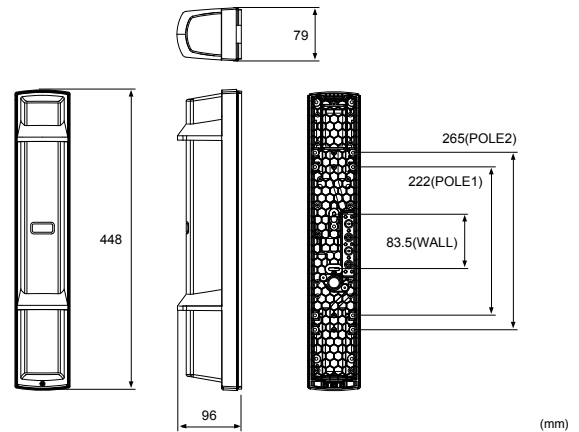

OPTIONS

- ABC-4 : Anti Bird Cap
- BC-4 : Back Cover
- PSC-4 : Pole Side Cover
- BAU-4 : Beam Alignment Unit
- HU-3 : Heating Unit
- CBR-4 : Conduit Bracket

SPECIFICATIONS

Model	SL-200QN	SL-350QN	SL-650QN
Maximum detection range	60m	100m	200m
Maximum arrival distance	600m	1000m	2000m
Detection method	Quad infrared beam interruption detection		
Interruption time	Variable between 50/100/250/500 ms (4 steps)		
Power source	10.5 to 30 VDC		
Current draw	38mA (Transmitter:8mA Receiver:30mA)	39mA (Transmitter:9mA Receiver:30mA)	40mA (Transmitter:10mA Receiver:30mA)
Output	Alarm output	Form C relay : 30 VDC, 0.2 A	
	Alarm period	2sec (±1) (Nominal)	
	Tamper output	N.C. (contact output) : 30 VDC, 0.1A Opens when cover removed.	
Operating temperature	-25 to +60°C		
Operating humidity	95% (max.)		
Alignment angle	±90° Horizontal, ±10° Vertical		
Dimension(H x W x D)	448mm x 79mm x 96mm		
Weight	2400g (Total weight of Transmitter + Receiver, excluding accessories)		
International protection	IP65		

Specifications and design are subject to change without prior notice.

SL-100TNR/200TNR

A-ZONE

SHORT RANGE BATTERY OPERATED PHOTOELECTRIC DETECTOR

Smart Line™ series

- SL-100TNR – detection range 30m
- SL-200TNR – detection range 60m



OPTIONS

- BCU-5 : Battery common Unit
- CRH-5 : CR123 Battery Holder
- PCU-5 : Power Convert Unit

DIMENSIONS

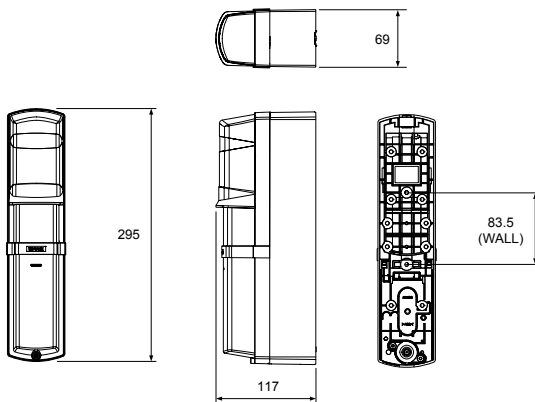

(mm)

FEATURES

- Universal powered operation
D size lithium battery x 4pcs
CR123A lithium battery x 16 pcs (OPTION CRH-5)
- 12-24VDC hardwired operation of the detector.
(OPTION PCU-5)
- Versatile alarm signal operation
- IR signal technology transmits the low battery status to the receiver.
- Simplified battery replacement
- Easy to access the battery holder and change batteries.

SPECIFICATIONS

Model		SL-100TNR	SL-200TNR
Maximum detection range		30 m	60 m
Maximum arrival distance		265 m	530 m
Detection method Twin infrared beam interruption detection			
Interruption time Variable between 50/100/250/500 ms (4 steps)			
Power source 3.6 to 3.9VDC D size lithium batteries Each Transmitter and Receiver: 2 units (SB-D02HP manufactured by VITZROCELL) Each Transmitter and Receiver: 8 units 3.0VDC CR123A lithium batteries (OPTION CRH-5: 2unit)			
Current draw (stand by/ at 25°C)	3.9VDC	Total: Approx. 500 µA Transmitter: Approx. 200 µA Receiver: Approx. 300 µA	Total: Approx. 600 µA Transmitter: Approx. 300 µA Receiver: Approx. 300 µA
	3.0VDC	Total: Approx. 600 µA Transmitter: Approx. 200 µA Receiver: Approx. 400 µA	Total: Approx. 700 µA Transmitter: Approx. 300 µA Receiver: Approx. 400 µA
Battery life**	SB-D02HP by VITZROCELL	Transmitter: Approx. 6 years Receiver: Approx. 5 years	Transmitter: Approx. 5 years Receiver: Approx. 5 years
	CRH-5 (CR123A by Panasonic)	Transmitter: Approx. 1.5 years Receiver: Approx. 1 year	Transmitter: Approx. 1 year Receiver: Approx. 1 year
Output	Alarm output	Form C-Solid State Switch: 3.6VDC, 0.01 A	
	Alarm period	2 s (±1)	
	Low battery output	N.C. (Solid State Switch): 3.6VDC, 0.01 A	
Indicator LED	Cover tamper output (Receiver)	N.C. (Solid State Switch): 3.6VDC, 0.01 A Opens when the battery cover removed.	
	Alarm/ Level indicator (Receiver)	ON:Beam not received Blinking:Beam not received sufficiently OFF:Beam received	
Operating temperature	Power/ Low battery indicator (Transmitter and Receiver)	ON:Power ON Blinking:Voltage reduction OFF:Power OFF	
	Operating humidity	-20°C to +60°C	
Alignment angle	95 % (max.)		
Dimension	±90° Horizontal, ±5° Vertical		
Weight	H x W x D mm : 295 x 69 x 117		
International protection	1200 g (Total weight of Transmitter + Receiver, excluding accessories)		
	IP65		

Specifications and design are subject to change without prior notice.

* The value is based on the condition that it is used within the ambient temperature range of 20 to 25°C.

** Using batteries other than those recommended may shorten the battery life.

OUTDOOR PROTECTION

INDOOR PROTECTION

REDWALL

ACCESS CONTROL

TECHNICAL INFORMATION

SL-350QFR/350QNR

A-ZONE

BATTERY OPERATED PHOTOELECTRIC DETECTOR

Smart Line™ series

OUTDOOR PROTECTION

INDOOR PROTECTION

REDWALL

ACCESS CONTROL

TECHNICAL INFORMATION



WIRELESS-READY

The SL-350QFR and SL-350QNR, our wireless ready, battery operated photoelectric detectors are designed to work with most manufacturer's wireless transmitters, and the back box has enough space to accommodate them. They are easy deployable and adaptable to any control systems currently installed.



LONG BATTERY LIFE

Approx. 4 years Max. 8 years

Low current consumption
 Transmitter 420µA (0.42mA)
 Receiver 325µA (0.325mA)

When using LSH20 (3.6V,13Ah) batteries manufactured by SAFT.



	Transmitter	Receiver
4 pcs	Approx. 8 years	Approx. 10 years
2 pcs	Approx. 4 years	Approx. 5 years

OPTIONS

- ABC-4 : Anti Bird Cap
- BC-4 : Back Cover
- PSC-4 : Pole Side Cover
- BAU-4 : Beam Alignment Unit
- EC-4 : Extension Cable with Connector
- BCU-5 : Battery Common Unit

Optex offers a less expensive and more efficient solution with SL-350QFR/SL-350QNR.

Typical perimeter systems require expensive trenching or much time for installation.

Expensive wire conduit runs and concrete works are unnecessary, allowing installers to save time and money.

- SL-350QFR – 4ch. beam frequencies selectable model
- SL-350QNR – standard model

FEATURES

- Long distance 100m
- Long battery life 4 to 8 years
- Wireless ready
- Sniper viewfinder with 2X magnification lens
- International protection IP65
- Spacious back box

DIMENSIONS

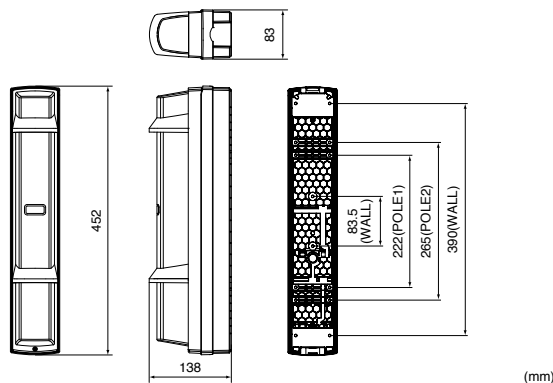

SPECIFICATIONS

Model	SL-350QFR	SL-350QNR
Maximum detection range	100m	
Maximum arrival distance	1000m	
Detection method	Quad infrared beam interruption detection	
Selectable beam frequency	4 channels	–
Interruption period	Variable between 50/100/250/500 ms (4 steps)	
Power source	Recommend: 3.6 V, 13.0Ah LSH20 lithium batteries manufactured by SAFT Operating range: 3.2 V to 4.0 V lithium batteries Transmitter: 2 or 4 units, Receiver: 2 or 4 units	
Current draw	745µA Transmitter: 420µA + Receiver: 325µA (at 25°C, 3.6 VDC)	
Battery life **	Transmitter: Approx. 4 years Receiver: Approx. 5 years	
Output	Alarm output	Form C-Solid State Switch: 3.6 VDC, 0.01 A
	Alarm period	2 sec (±1) (Nominal)
	D.Q output	Form C-Solid State Switch: 3.6 VDC, 0.01 A (Receiver only)
	Low battery output	N.C. (solid state switch): 3.6 VDC, 0.01 A
Indicator	Alarm (Receiver)	Alarm: ON Light receiving: OFF
	Level (Receiver)	Not Light receiving: OFF Light receiving: Flickering or OFF
	Power (Transmitter)	Power ON: ON Power OFF: OFF
	Low battery	Voltage reduction: Flickering
Operating temperature	-20 to +60°C	
Environmental humidity	95 % (max.)	
Alignment angle	±90° Horizontal, ±10° Vertical	
Dimensions (H x W x D)	452mm x 83mm x 138mm	
Weight	3300 g (Total weight of Transmitter + Receiver, excluding accessories)	
International protection	IP65	

Specifications and design are subject to change without prior notice.

* The value is based on the condition that it is used within the ambient temperature range of 20 to 25°C. (LSH-20 x2 pcs)

** Using batteries other than those recommended may shorten the battery life. Batteries and wireless transmitters are not included in these products.

AX-100TFR/200TFR

A-ZONE

BATTERY OPERATED PHOTOELECTRIC DETECTOR



The AX-100/200TFR series are "REVOLUTION" in the perimeter security industry, offering significant cost saving alternatives to traditional hardwired system.

- AX-100TFR – detection range 30m
- AX-200TFR – detection range 60m

Easy battery replacement

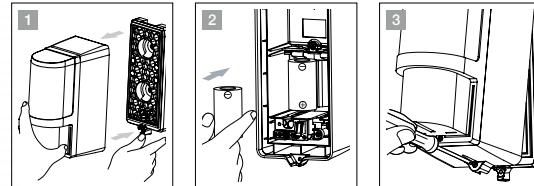

FEATURES

- Long battery life AX-100TFR: approx. 5 years
AX-200TFR: approx. 3 years(transmitter)
approx. 5 years(receiver)
- Easy battery replacement
- Triple tamper functions
- Low battery output and LED indication
- Intermittent output function
- Compatible with numerous wireless transmitters
- Battery saving timer function for wireless transmitters

RANGES

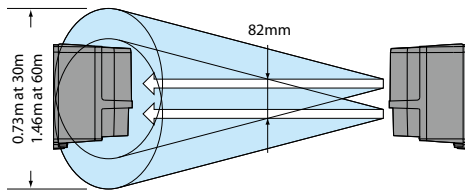

OPTIONS

- MP-4 : Main unit mounting bracket set (for tower mounting)
- BCU-5 : Battery Common Unit

DIMENSIONS

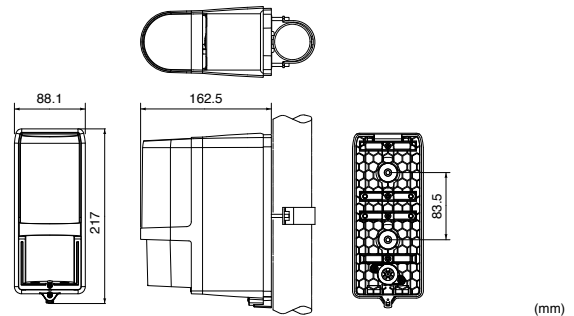

SPECIFICATIONS

Model	AX-100TFR	AX-200TFR
Maximum detection range	30m	60m
Maximum arrival distance	265m	530m
Detection method	Infrared beam interruption detection	
Selectable beam frequency	4 channels	
Interruption period	Variable between 50, 100, 250, 500msec (4 steps)	
Power source	3.6V 13.0Ah : LSH20 lithium batteries manufactured by SAFT (not included) Transmitter : 2 units Receiver : 2 units	
Current draw	620µA T:300µA + R:320µA (at 25°C, 3.6 VDC)	810µA T:490µA + R:320µA (at 25°C, 3.6 VDC)
Battery life	5 years	Transmitter 3 years Receiver 5 years
Output	Alarm output	Form C-Solid State Switch : 3.6 VDC, 0.01A
	Alarm period	2 sec (±1) nominal
	D.Q. output	Form A/B-Solid State Switch : 3.6 VDC, 0.01A
	Low battery output	Form A/B-Solid State Switch: 3.6 VDC, 0.01A (Transmitter & Receiver)
	Tamper output for Front cover	Form C: 3.6 VDC, 0.01 A activates when cover removed. (Receiver only)
Tamper output for Back box	Form C: 3.6 VDC, 0.01 A activates when either back box or chassis is removed from the installment.	
Indicator	Alarm (Receiver)	(1) Light on - IR Beam not received. (2) Flickering Light - IR Beams not received sufficiently. (3) Light off - IR Beams received.
	Power (Transmitter)	Power ON : ON, Power OFF : OFF
	Low battery	Voltage Reduction : flicker
Operating temperature	-20 to +60°C	
Environmental humidity	95%(Max.)	
Alignment angle	± 90° Horizontal, ± 5° Vertical	
Mounting	Indoor/Outdoor, Wall/Pole/Tower mounting (Optional main unit mounting brackets are required, when the units mount in the tower.)	
Weight	1600 g (Total weight of transmitter + receiver, excluding accessories)	
International protection	IP55	

Specifications and design are subject to change without prior notice.
Batteries and wireless transmitters are not included in these products.

OUTDOOR PROTECTION

INDOOR PROTECTION

RED WALL

ACCESS CONTROL

TECHNICAL INFORMATION

AX-100TF/200TF

A-ZONE

SELECTABLE BEAM FREQUENCY SHORT RANGE PHOTOELECTRIC DETECTOR

OUTDOOR PROTECTION

INDOOR PROTECTION

RED WALL

ACCESS CONTROL

TECHNICAL INFORMATION



The AX-100/200TF series of short range photoelectric detectors are compact in design with selectable beam frequencies.

Also the AX-100TF/200TF series carries the IP65 high durable structure which prevents water, dust or bugs from getting into the unit.

- AX-100TF – detection range 30m
- AX-200TF – detection range 60m

FEATURES

- Selectable 4 channels beam frequency
- 4 step alarm indicator LED
- Environmental disqualification circuit
- International protection IP65
- Lightning and surge protection
- Anti-frost hood cover
- 99% beam blocking stability
- A.G.C. (Automatic Gain Control) circuit
- Adjustable beam interruption time

RANGES

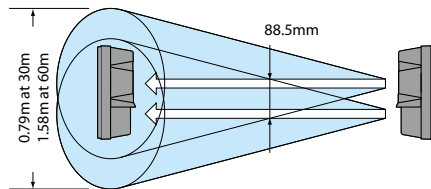

DIMENSIONS

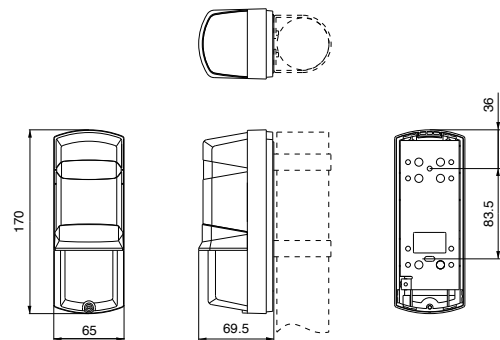

(mm)

OPTIONS

- HU-3 : Heating Unit
24V DC/AC, 420mA max.
- BC-3 : Back Cover
- PSC-3 : Pole Side Cover
Cover for installing 2 units to 1 pole

SPECIFICATIONS

Model	AX-100TF	AX-200TF
Maximum detection range	30m	60m
Maximum arrival distance	300m	600m
Selectable beam frequency	4 channels	
Interruption period	Selectable between 50, 100, 250, and 500 msec.	
Power supply	10.5 to 28 VDC	
Current consumption (transmitter + receiver)	44mA (max.)	48mA (max.)
Alarm period	2 sec. (±1) nominal	
Alarm output	N.C./N.O. 28 VDC 0.2A max.	
Tamper switch	N.C. opens when cover is removed at 28 VDC, 0.1A max.	
Operating temperature	-35 to +60°C Use the optional heating unit (HU-3) under the environment of -25°C or less minus.	
Environmental humidity	95% max.	
Alignment angle	±90° Horizontal, ±5° Vertical	
Mounting	Wall and pole mounting	
Weight (transmitter+receiver)	700 g	
Dimensions (H x W x D)	170 mm x 65 mm x 69.5 mm	
International protection	IP65	

Specifications and design are subject to change without prior notice.

AX-70TN/130TN/200TN

A-ZONE

SHORT RANGE PHOTOELECTRIC DETECTOR



The AX-70/130/200TN series of short range photoelectric detectors are compact in design with IP65 high durable structure.

- AX-70TN – detection range 20m
- AX-130TN – detection range 40m
- AX-200TN – detection range 60m

FEATURES

- International protection IP65
- Lightning and surge protection
- Anti-frost hood cover
- 99% beam blocking stability
- A.G.C. (Automatic Gain Control) circuit
- Adjustable interruption time

RANGES

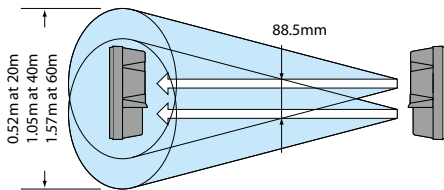

DIMENSIONS

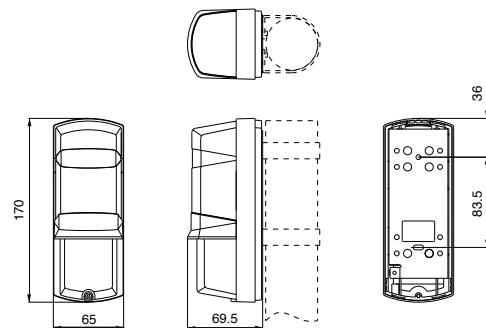

(mm)

OPTIONS

- HU-3 : Heating Unit
24V DC/AC, 420mA max.
- BC-3 : Back Cover
- PSC-3 : Pole Side Cover
Cover for installing 2 units to 1 pole

SPECIFICATIONS

Model	AX-70TN	AX-130TN	AX-200TN
Maximum detection range	20m	40m	60m
Maximum arrival distance	200m	400m	600m
Interruption period	Selectable between 50, 100, 250, and 500 msec.		
Power supply	10.5 to 28 VDC		
Current consumption (transmitter + receiver)	38mA (max.)	41mA (max.)	45mA (max.)
Alarm period	2 sec. (±1) nominal		
Alarm output	N.C. 28 VDC 0.2A max.		
Tamper switch	N.C. opens when cover is removed at 28 VDC, 0.1A max.		
Operating temperature	-35 to +60°C Use the optional heating unit (HU-3) under the environment of -25°C or less minus.		
Environmental humidity	95% max.		
Alignment angle	±90° Horizontal, ±5° Vertical		
Mounting	Wall and pole mounting		
Weight (transmitter+receiver)	650 g		
Dimensions (H x W x D)	170 mm x 65 mm x 69.5 mm		
International protection	IP65		

Specifications and design are subject to change without prior notice.

OUTDOOR PROTECTION

INDOOR PROTECTION

REDWALL

ACCESS CONTROL

TECHNICAL INFORMATION

OPTIONS

ABC-4



1 set (2 units)

Anti Bird Cap
for

- SL-200QDM/350QDM/650QDM
- SL-200QDP/350QDP/650QDP
- SL-200QN/350QN/650QN
- SL-350QFR/SL-350QNR

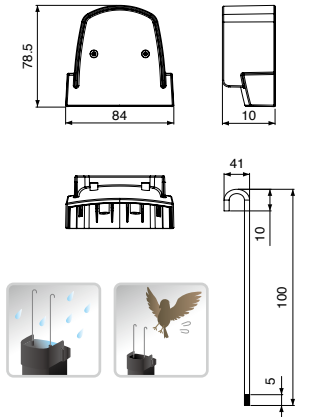

(mm)

BC-3

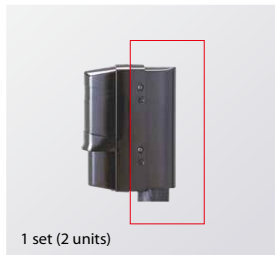

1 set (2 units)

Back Cover
for

- AX-100TF/200TF
- AX-70TN/130TN/200TN

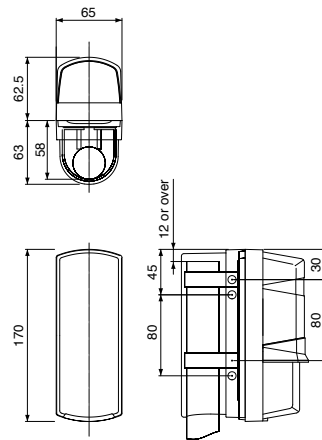

(mm)

BC-4

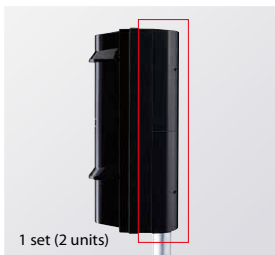

1 set (2 units)

Back cover
for

- SL-200QDM/350QDM/650QDM
- SL-200QDP/350QDP/650QDP
- SL-200QN/350QN/650QN
- SL-350QFR/350QNR

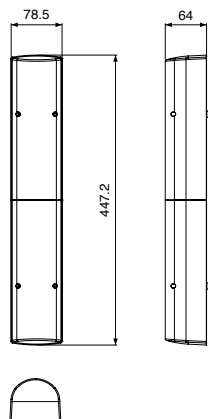

(mm)

PSC-3



1 unit

Pole Side Cover
for

- AX-100TF/200TF
- AX-70TN/130TN/200TN

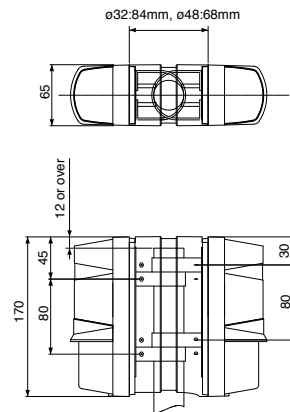

(mm)

PSC-4

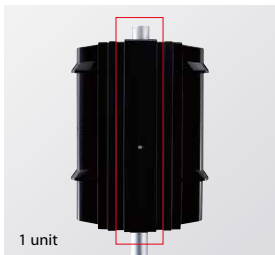

1 unit

Pole Side Cover
for

- SL-200QDM/350QDM/650QDM
- SL-200QDP/350QDP/650QDP
- SL-200QN/350QN/650QN
- SL-350QFR/350QNR

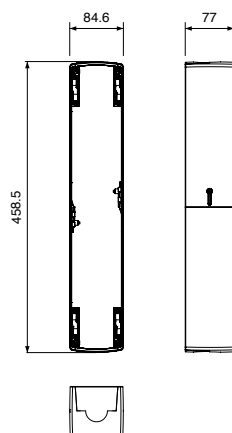

(mm)

CBR-4

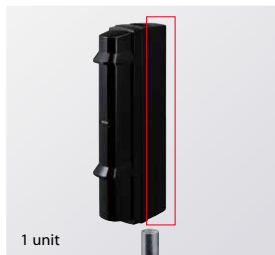

1 unit

Conduit Bracket
for

- SL-200QDM/350QDM/650QDM
- SL-200QDP/350QDP/650QDP
- SL-200QN/350QN/650QN

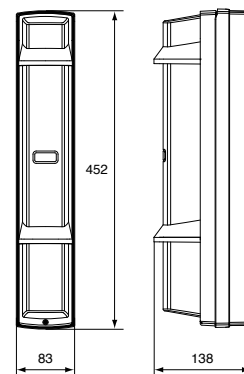

(mm)

HU-3



1 set (2 units)

Heating Unit for

- SL-200QDM/350QDM/650QDM
- SL-200QDP/350QDP/650QDP
- SL-200QN/350QN/650QN
- AX-100TF/200TF
- AX-70TN/130TN/200TN

*2sets (4 units) are used for SL series.

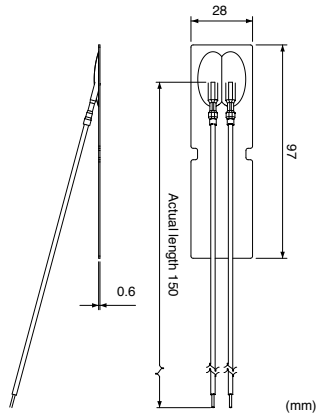

Power input	24VAC/DC
Current draw	420mA(max.) (Per 1 unit)
Thermo switch	60°C (140°F)

MP-4



1 set (2 units)

Main Unit Mounting Bracket Set (for Tower Mounting) for

- AX-100TFR/200TFR

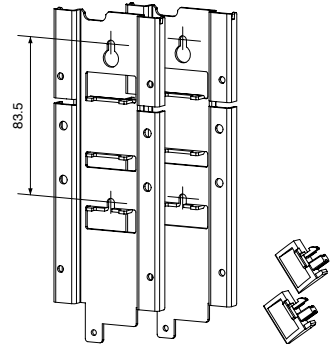

Main unit mounting bracket Tamper bushing

(mm)

BCU-5



1 unit

Share power source and low battery signals between the main unit and the wireless transmitter.

for

- SL-100TNR/200TNR
- AX-100TFR/200TFR
- SL-350QFR/350QNR

Input voltage	3.2 - 4.0 VDC	
Current draw	Approx. 5 μ A at 3.6 VDC (no load)	
Output voltage	Normal	Approx. 2.3 - 3.6 VDC
	Low battery	Approx. 2.0 - 2.6 VDC
Output current	100 mA (max.)	
Operating temperature	-20°C - +60°C (-4°F - +140°F)	
Operating humidity	95% (max.)	

Package contents

- 1 X PC board
- 2 X Dummy battery
- 3 X Power cable

BAU-4 (Sales ends when all the stock is sold out)



1 unit

Aligns optical axis automatically. (SL-QDP/QN/QFR/QNR: applicable to receiver only)

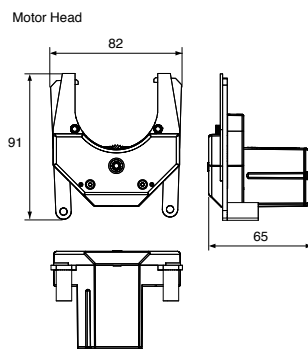

Controller
Dimensions (HxWxD): 180mm x 120mm x 45mm

CRH-5

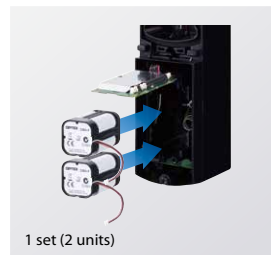

1 set (2 units)

Battery holder when using CR123A as a power source.
CR123A: Transmitter x 8pcs,
Receiver x 8pcs
Battery life: Approx. 1year



Only for SL-100TNR/200TNR

PCU-5

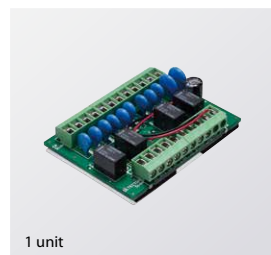

1 unit

Voltage converter unit used to enable wired operation of the detector.

Power input	10.5 - 30 VDC
Current draw	80 mA (max.)
Output voltage	Approx. 3.9 VDC
Output current	10 mA (max.)
Alarm output	Form C relay: 30 VDC, 0.2 A
D.Q. output	Unused (Form C relay: 30 VDC, 0.2 A)
Low battery output	N.C. relay: 30 VDC, 0.2 A
Tamper output	N.C. relay: 30 VDC, 0.2 A
Operating temperature	-20°C - +60°C (-4°F - +140°F)
Operating humidity	95% (max.)

EC-4

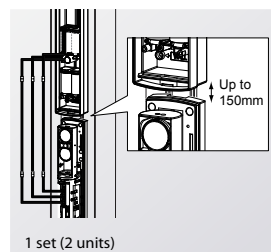

1 set (2 units)

Extension Cable with Connector for

- SL-350QFR/SL-350QNR

(mm)

PRODUCT SPECIFICATIONS







OUTDOOR PROTECTION

INDOOR PROTECTION







REDWALL

ACCESS CONTROL

TECHNICAL INFORMATION

	SL-200QDM	SL-350QDM	SL-650QDM	SL-200QDP	SL-350QDP	SL-650QDP
						
	P06	P06	P06	P07	P07	P07
Detection method	Infrared beam interruption detection					
Maximum detection range	60m	100m	200m	60m	100m	200m
Maximum arrival range	600m	1000m	2000m	600m	1000m	2000m
Number of beams	Quad	Quad	Quad	Quad	Quad	Quad
Beam characteristics	Pulsed infrared	Pulsed infrared	Pulsed infrared	Pulsed infrared	Pulsed infrared	Pulsed infrared
Double Modulation	✓	✓	✓	✓	✓	✓
Beam blocking ratio	99%	99%	99%	99%	99%	99%
4 Ch. Selectable beam frequency	✓	✓	✓	✓	✓	✓
Interruption period	50,100,250,500msec.	50,100,250,500msec.	50,100,250,500msec.	50,100,250,500msec.	50,100,250,500msec.	50,100,250,500msec.
Mounting	Wall / Pole/Tower	Wall / Pole/Tower	Wall / Pole/Tower	Wall / Pole/Tower	Wall / Pole/Tower	Wall / Pole/Tower
Alignment angle	+/- 90° Horizontal	+/- 90° Horizontal	+/- 90° Horizontal	+/- 90° Horizontal	+/- 90° Horizontal	+/- 90° Horizontal
	+/- 10° Vertical	+/- 10° Vertical	+/- 10° Vertical	+/- 10° Vertical	+/- 10° Vertical	+/- 10° Vertical
LED Indicator	✓ 16 steps & Sound assist	✓ 16 steps & Sound assist	✓ 16 steps & Sound assist	✓ 16 steps & Sound assist	✓ 16 steps & Sound assist	✓ 16 steps & Sound assist
Monitor jack for alignment	✓	✓	✓	✓	✓	✓
Beam alignment method	Sniper viewfinder™					
Lightning protection	✓	✓	✓	✓	✓	✓
Environmental disqualification output	✓	✓	✓	✓	✓	✓
Integrated alignment status communication (I.A.S.C.)	✓	✓	✓	—	—	—
Power supply	Normal: 10.5 - 30 VDC	Normal: 10.5 - 30 VDC	Normal: 10.5 - 30 VDC	10.5 - 30 VDC	10.5 - 30 VDC	10.5 - 30 VDC
Current consumption	40 mA max.	40 mA max.	43mA max.	24 mA max.	24 mA max.	33 mA max.
Alarm output	FormC	FormC	FormC	FormC	FormC	FormC
Tamper	✓	✓	✓	✓	✓	✓
Alarm memory	✓	✓	✓	✓	✓	✓
Anti-frost design	✓	✓	✓	✓	✓	✓
Optional heating unit	HU-3	HU-3	HU-3	HU-3	HU-3	HU-3
International protection	IP65	IP65	IP65	IP65	IP65	IP65
Operating temperature	-35 to +60°C	-35 to +60°C	-35 to +60°C	-35 to +60°C	-35 to +60°C	-35 to +60°C
Operating humidity	95% max	95% max	95% max	95% max	95% max	95% max
Dimensions (H x W x D mm)	448 x 79 x 96	448 x 79 x 96	448 x 79 x 96	448 x 79 x 96	448 x 79 x 96	448 x 79 x 96

PRODUCT SPECIFICATIONS

SL-200QN/350QN/ 650QN	SL-100TNR/200TNR	SL-350QFR/QNR	AX-100TFR/200TFR	AX-100TF/AX-200TF	AX-70TN/130TN/200TN	BX-100PLUS
						
P08	P09	P10	P11	P12	P13	P39
Infrared beam interruption detection						
60m/100m/200m	30m/60m	100m	30m/60m	20m/40m/60m	20m/40m/60m	30m
600m/1000m/2000m	256m/530m	1000m	265m/530m	200m/400m/600m	200m/400m/600m	300m
Quad	Twin	Quad	Twin	Twin	Twin	Twin
Pulsed infrared	Pulsed infrared	Pulsed infrared	Pulsed infrared	Pulsed infrared	Pulsed infrared	Pulsed infrared
—	—	—	—	—	—	—
99%	99%	99%	99%	99%	99%	99%
—	—	✓ (SL-350QFR)	✓	✓	—	—
50,100,250,500msec.	50,100,250,500msec.	50,100,250,500msec.	50,100,250,500msec.	50,100,250,500msec.	50,100,250,500msec.	50msec
Wall / Pole/Tower	Wall/Pole	Wall / Pole/Tower	Wall / Pole/Tower	Wall / Pole	Wall / Pole	Wall
+/- 90° Horizontal	+/- 90° Horizontal	+/- 90° Horizontal	+/- 90° Horizontal	+/- 90° Horizontal	+/- 90° Horizontal	+/- 92° Horizontal
+/- 10° Vertical	+/- 5° Vertical	+/- 10° Vertical	+/- 5° Vertical	+/- 5° Vertical	+/- 5° Vertical	
—	✓	✓4steps	✓4steps	✓4steps	—	—
✓	✓	✓	✓	✓	✓	—
Sniper viewfinder™			View finder	View finder	View finder	Audible indicator
✓	—	—	—	✓ over 14kV	✓ over 14kV	✓ over 6kv
—	✓	✓	✓	✓	—	—
—	—	—	—	—	—	—
10.5 - 30 VDC	3.6 to 3.9V DC D size (SB-D02HP) / 3.0V DC CR123A (option CRH-5) Lithium batteries	3.6V 13.0Ah LSH20 Lithium batteries	3.6V 13.0Ah LSH20 Lithium batteries	10.5 - 28 VDC	10 - 28 VDC	10.5 - 28 VDC
38mA max/39mA max/40mA max	Max. 600µA/Max. 700µA	745µA max	620µA max/810µA max	44 mA max./48mA max.	35mA max	75mA max
FormC	FormC-solid state switch	FormC	FormC	N.C.	N.C.	2 outs N.O./N.C.
✓	N.C.-solid state switch (receiver)	✓	✓	✓	✓	✓
—	—	—	—	✓	—	—
✓	✓	✓	✓	✓	✓	—
HU-3	—	—	—	HU-3	HU-3	—
IP65	IP65	IP65	IP55	IP65	IP65	IP54
-25 to +60°C	-20 to +60°C	-20 to +60°C	-20 to +60°C	-35 to +65°C	-35 to +65°C	-35 to +55°C
95% max	95% max	95% max	95% max	95% max	95% max	95% max
448 x 79 x 96	295 x 69 x 117	452 x 83 x 138	217 x 88.1 x 162.5	170 x 65 x 69.5	170 x 65 x 69.5	230.5x 51.5x 61

OUTDOOR PROTECTION

INDOOR PROTECTION

REDWALL

ACCESS CONTROL

TECHNICAL INFORMATION

WXS-AM/DAM

B-ZONE

180 DEGREE PANORAMIC OUTDOOR PIR DETECTOR



COVERAGE

TOP VIEW

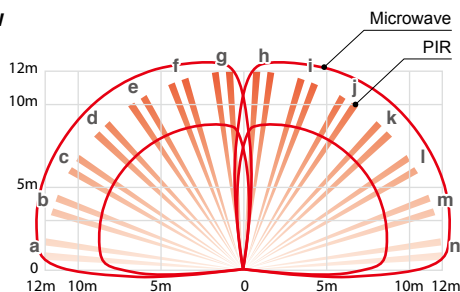

SIDE VIEW

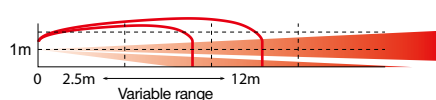

DIMENSIONS

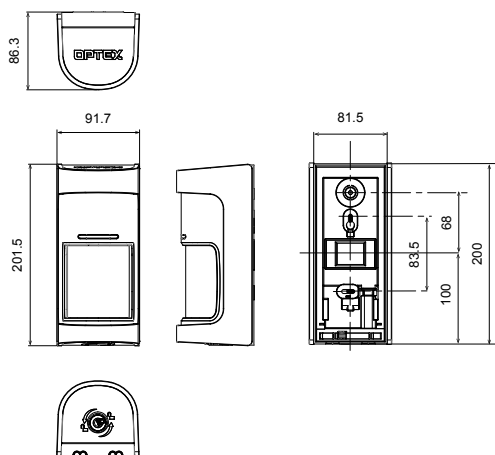

Part of the Shield family, the WXS series is OPTEX's latest 180° outdoor intrusion detection sensors with flexible range detection and settings, as well as a selectable low (0.8 - 1.2m) or high mount (2m) option and self-learning IR digital anti-masking.

- WXS-AM – active IR anti-masking model
- WXS-DAM – dual technology model with active IR anti-masking

FEATURES

- Selectable mounting height
- 4PIR + 2MW technology (WXS-DAM only)
- Stability against light disturbance (WXS-DAM only)
- Individual detection area size (WXS-DAM only)
- Panoramic triple layer detection (WXS-DAM only)
- Individual sensitivity setting
- Individual alarm outputs
- Self-learning IR digital anti-masking function
- Blue Touch
- Day /night mode
- Area masking shutter
- Area masking plate
- SMDA (Super Multidimensional Analysis) logic
- Cover / Back tamper

SPECIFICATIONS

Model	WXS-AM	WXS-DAM
Detection method	Passive infrared	Passive infrared & Microwave
PIR coverage	High mount : 9.0 m (30') 180°wide Low mount : 12.0 m (40') 180°wide	
PIR distance limit	High mount : 9.0 m (fixed) Low mount : 2.5 to 12.0 m (Stepless adjustment)	
Detectable speed	0.3 to 2.0 m/s (1' to 6'7"/s)	
Sensitivity	2.0 °C (3.6°F) at 0.6 m/s Selectable for each side individually	
Power input	9.5 – 18 VDC	
Current draw	23 mA max. at 12 VDC	24 mA max. at 12 VDC
Alarm period	2.0 ± 1 sec.	
Warm-up period	Approx. 60 sec. (LED blinks)	
Alarm output	Alarm output (Right) 28 VDC 0.1 A max. [Individual : Right or General], [N.O. or N.C.] are selectable Alarm output (Left) 28 VDC 0.1 A max. [Individual : Left or General], [N.O. or N.C.] are selectable	
Trouble output	N.C. 28 VDC 0.1 A max.	
Tamper output	N.C. 28 VDC 0.1 A max. Open when either the cover, main or base unit is removed	
LED indicator	Red 1. Warm-up 2. Alarm 3. Masking detection 4. "High mount" setting (When the tamper switch is activated, LED blinks if it is "High mount" setting.) Yellow 1. Warm-up 2. MW detection	
Operating temperature	-30°C to +60°C (-22°F to +140°F)	20°C to +45°C (-4°F to +113°F)
Environment humidity	95% max.	
International protection	IP55	
Mounting	Wall, Pole (Outdoor, Indoor)	
Mounting height	High mount : 2.0 m (6' 7") Low mount : 0.8 to 1.2 m (2' 7" to 4')	
Weight	585 g (20.7 oz)	625 g (22.1 oz)
Accessories	[1] Area masking plate x 5 [2] Mounting screw (4 x 20 mm) x 2 [3] Lock screw x 1	

Specifications and designs are subject to change without prior notice.

OPTIONS

- PEU-B/C/D/E/F/G/H/I/J/K : Selectable plug-in end of line unit
- PMP-01 : Pole mount plate
- BH-01 : Battery holder
- WXI-BB : Back box
- MKP-01 : Area masking plate

(mm)

WXS-RAM/RDAM

B-ZONE

BATTERY OPERATED 180 DEGREE PANORAMIC OUTDOOR PIR DETECTOR



COVERAGE

TOP VIEW

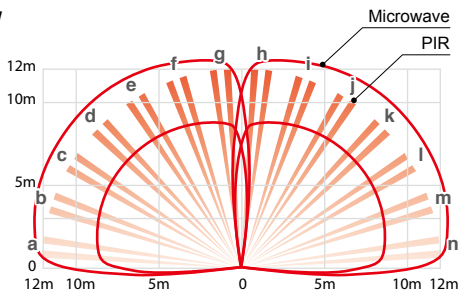

SIDE VIEW

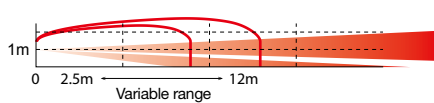

DIMENSIONS

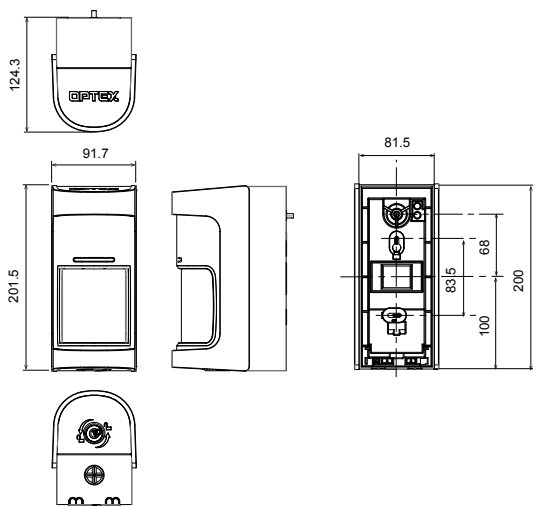

(mm)

The WX Shield "R" models are battery operated products. Sharing the same design and performance with WXS-AM/DAM, "R" models have the most up-to-date outdoor protection capabilities.

- WXS-RAM – battery operated model
- WXS-RDAM – battery operated dual technology model with active IR anti-masking

FEATURES

- Selectable mounting height
- 4PIR + 2MW technology (WXS-RDAM only)
- Stability against light disturbance (WXS-RDAM only)
- Individual detection area size (WXS-RDAM only)
- Panoramic triple layer detection (WXS-RDAM only)
- Individual sensitivity setting
- Individual alarm outputs
- Self-learning IR digital anti-masking function
- Blue Touch
- Day /night mode
- Area masking shutter
- Area masking plate
- SMDA (Super Multidimensional Analysis) logic
- Cover / Back tamper

SPECIFICATIONS

Model	WXS-RAM	WXS-RDAM
Detection method	Passive infrared	Passive infrared & Microwave
PIR coverage	High mount : 9.0 m (30') 180°wide Low mount : 12.0 m (40') 180°wide	
PIR distance limit	High mount : 9.0 m (fixed) Low mount : 2.5 to 12.0 m (Stepless adjustment)	
Detectable speed	0.3 to 2.0 m/s (1' to 6'7"/s)	
Sensitivity	2.0 °C (3.6°F) at 0.6 m/s Selectable for each side individually	
Power input	3 to 3.6 VDC lithium batteries	
Current draw	19 µA stand-by 4 mA max. at 3 VDC	24 µA stand-by 6 mA max. at 3 VDC
Alarm period	2.0 ± 1 sec.	
Warm-up period	Approx. 60 sec. (LED blinks)	
Alarm output	Alarm output (Right) Solid State switch, 10 VDC 0.01 A max. [Individual : Right or General], [N.O. or N.C.] are selectable Alarm output (Left) Solid State switch, 10 VDC 0.01 A max. [Individual : Left or General], [N.O. or N.C.] are selectable	
Trouble output	Solid State switch, 10 VDC 0.01 A max. [N.O. or N.C.] are selectable (with tamper)	
Tamper output	Tamper output is shared with trouble output.	
LED indicator	Red 1. Warm-up 2. Alarm 3. Masking detection 4. "High mount" setting (When the tamper switch is activated, LED blinks if it is "High mount" setting.) Yellow 1. Warm-up 2. MW detection	
Operating temperature	-30°C to +60°C (-22°F to +140°F)	20°C to +45°C (-4°F to +113°F)
Environment humidity	95% max.	
International protection	IP55	
Mounting	Wall, Pole (Outdoor, Indoor)	
Mounting height	High mount : 2.0 m (6' 7") Low mount : 0.8 to 1.2 m (2' 7" to 4')	
Weight	730 g (25.8 oz.)	770 g (27.2 oz.)
Accessories	[1] Connector for POWER and ALARM (R) [2] Connector for ALARM (L) [3] Connector for TROUBLE [4] Velcro tape [5] Area masking plate x 5 [6] Mounting screw (4 x 20 mm) x 2 [7] Lock screw x 1	

Specifications and designs are subject to change without prior notice.

OPTIONS

- PMP-01 : Pole mount plate
- BH-01 : Battery holder
- WXI-BB : Back box
- MKP-01 : Area masking plate

OUTDOOR PROTECTION

INDOOR PROTECTION

REDWALL

ACCESS CONTROL

TECHNICAL INFORMATION

WXI-ST/AM

180 DEGREE PANORAMIC OUTDOOR DETECTOR

OUTDOOR PROTECTION

INDOOR PROTECTION

REDWALL

ACCESS CONTROL

TECHNICAL INFORMATION



With its comprehensive 180° field of view and capabilities to tailor its setting to meet the environment around your premise, the WX Infinity series will provide an effective solution for new and existing security systems.

- WXI-ST – standard model
- WXI-AM – active IR anti-masking model

FEATURES

- Individual alarm outputs
- Individual sensitivity setting
- Individual detection area size
- Area masking shutter
- Area masking plate
- Self-learning IR digital anti-masking function
- SMDA (Super Multidimensional Analysis) logic
- Double conductive shielding
- Intelligent AND detection logic
- Active IR digital anti-masking (WXI-AM)
- Cover / Back tamper

COVERAGE

TOP VIEW

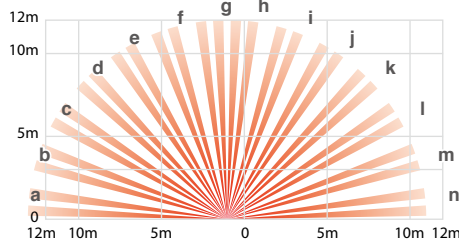

SIDE VIEW

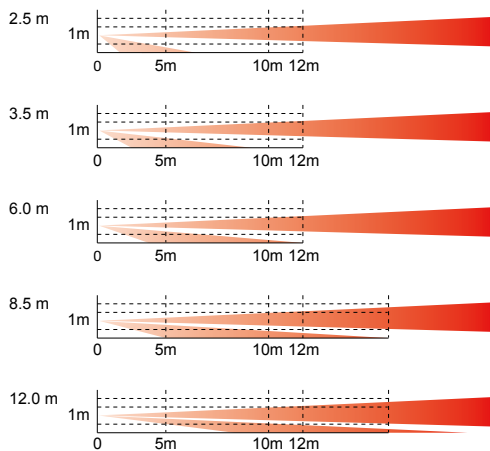

OPTIONS

- PEU-B/C/D/E/F/G/H/I/J/K : Selectable plug-in end of line unit
- PMP-01 : Pole mount plate
- MKP-01 : Area masking plate
- WXI-BB : Back box

DIMENSIONS

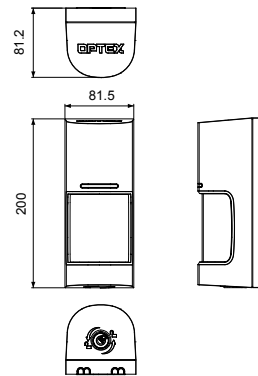

(mm)

SPECIFICATIONS

Model	WXI-ST	WXI-AM
Detection method	Passive infrared	
PIR coverage	180° wide	
PIR distance limit	2.5 to 12 m (Stepless adjustment)	
Detectable speed	0.3 to 2.0 m/s (1' to 6'7"/s)	
Sensitivity	2.0 °C (3.6°F) at 0.6 m/s Selectable for each side individually	
Power input	9.5 to 18 VDC	
Current draw	21 mA max. at 12 VDC	23 mA max. at 12 VDC
Alarm period	2.0 ± 1 sec.	
Warm-up period	60 sec. or less (LED blinks)	
Alarm output	28 VDC 0.1 A max. [Individual; Right/Left or General], [N.O. or N.C.] are selectable	
Trouble output	-	N.C. 28 VDC 0.1 A max.
Tamper output	N.C. 28 VDC 0.1 A max. Open when either the cover, main or base unit is removed	
LED indicator	Red LED ; 1. Warm-up 2. Alarm	Red LED ; 1. Warm-up 2. Alarm 3. Masking detection
Operating temperature	-30 °C to +60 °C (-22°F to +140°F)	
Environment humidity	95% max.	
International protection	IP55	
Mounting	Wall, Pole (Outdoor, Indoor)	
Mounting height	0.8 to 1.2 m (2'7" to 4')	
Weight	420 g	440 g
Accessories	Mounting screw (4 x 20 mm) x 2, lock screw x 1	

Specifications and designs are subject to change without prior notice.

WXI-R/RAM

B-ZONE

BATTERY OPERATED 180 DEGREE PANORAMIC OUTDOOR DETECTOR



The WX Infinity "R" models are battery operated products. Sharing the same design and performance with WXI-ST/AM, "R" models have the most up-to-date outdoor protection capabilities.

- WXI-R – battery operated model
- WXI-RAM – with active IR anti-masking

FEATURES

- Long battery life
- Individual alarm outputs
- Individual sensitivity setting
- Individual detection area size
- Area masking shutter
- Area masking plate
- Self-learning IR digital anti-masking function
- SMDA (Super Multidimensional Analysis) logic
- Double conductive shielding
- Intelligent AND detection logic
- Active IR digital anti-masking (WXI-RAM)
- Cover / Back tamper

COVERAGE

TOP VIEW

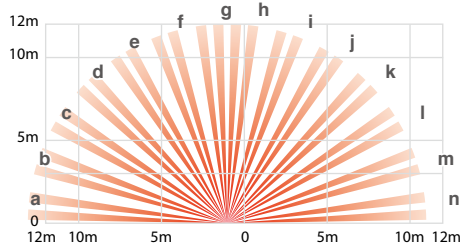

SIDE VIEW

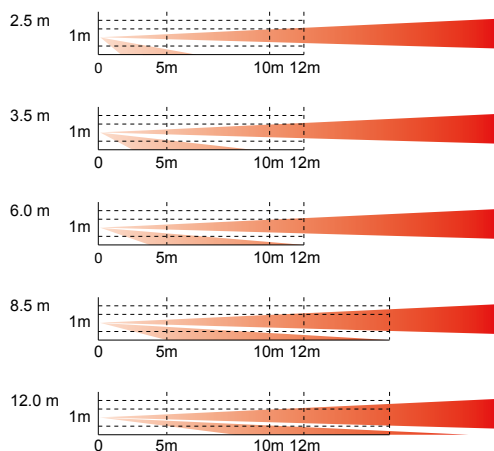

OPTIONS

- PMP-01 : Pole mount plate
- BH-01 : Battery holder
- WXI-BB : Back box
- MKP-01 : Area masking plate

DIMENSIONS

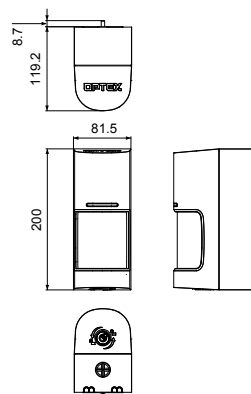

(mm)

SPECIFICATIONS

Model	WXI-R	WXI-RAM
Detection method	Passive infrared	
PIR coverage	180° wide	
PIR distance limit	2.5 to 12 m (Stepless adjustment)	
Detectable speed	0.3 to 2.0 m/s (1' to 6'7"/s)	
Sensitivity	2.0 °C (3.6°F) at 0.6 m/s Selectable for each side individually	
Power input	3 to 3.6 V DC lithium batteries	
Current draw	15 µA stand-by 4 mA max. at 3 V DC except walk test	16 µA stand-by 4 mA max. at 3 V DC except walk test
Alarm period	2.0 ± 1 sec.	
Warm-up period	60 sec. or less (LED blinks)	
Alarm output	Solidstate switch, 10 V DC 0.01 A max. [Individual; Right/Left or General], [N.O. or N.C.] are selectable	
Trouble output	Solidstate switch, 10 V DC 0.01 A max. [N.O. or N.C.] is selectable	
Tamper output	Tamper output is shared with trouble output.	
LED indicator	Red LED ; 1. Warm-up 2. Alarm	Red LED ; 1. Warm-up 2. Alarm 3. Masking detection
Operating temperature	-30 °C to +60 °C (-22°F to +140°F) except batteries	
Environment humidity	95% max.	
International protection	IP55	
Mounting	Wall, Pole (Outdoor, Indoor)	
Mounting height	0.8 to 1.2 m (2'7" to 4')	
Weight	600 g	
Accessories	Connector for POWER and ALARM (R), Connector for ALARM (L) Connector for TROUBLE, Velcro tape Mounting screw (4 x 20 mm) x 2, Lock screw x 1	

Specifications and design are subject to change without prior notice.

OUTDOOR PROTECTION

INDOOR PROTECTION

REDWALL

ACCESS CONTROL

TECHNICAL INFORMATION

VXS-AM/DAM

B-ZONE

WIDE ANGLE OUTDOOR PIR DETECTOR



COVERAGE

TOP VIEW (Area diagram for D position)

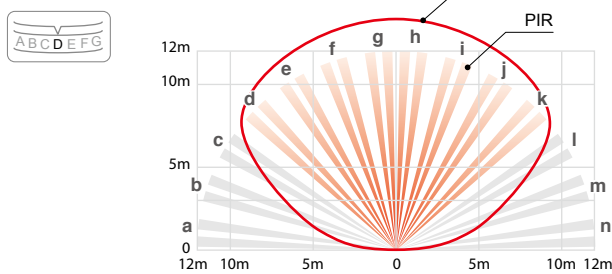

SIDE VIEW (Detection Distance by Positions)

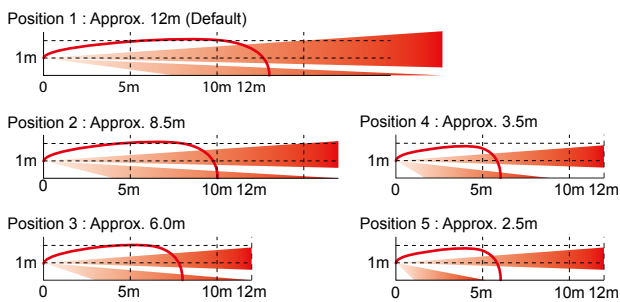

OPTIONS

- PEU-B/C/D/E/F/G/H/I/J/K : Selectable plug-in end of line unit
- VXS face cover (White / Silver / Black)
- VXS option cover unit (Black / white)

COLOR



The VX Shield is a series of outdoor sensors providing 12 m by 90 degree detection coverage. Anti-masking and dual technology models are available in a lineup.

- VXS-AM – active IR anti-masking model
- VXS-DAM – dual technology model with active IR anti-masking

FEATURES

- Active IR anti-masking
- SMDA (Super Multidimensional Analysis) logic
- Easy masking for over spill prevention
- Double conductive shielding
- Back tamper
- Automatic walk test mode

DIMENSIONS

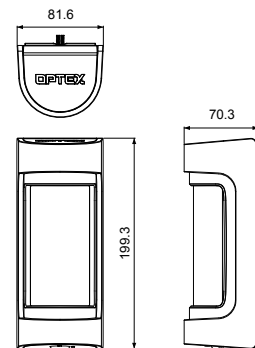

(mm)

SPECIFICATIONS

Model	VXS-AM	VXS-DAM
Detection method	Passive infrared	Passive infrared & Microwave
PIR coverage	12 m (40 ft) 90° wide / 16 zones	
PIR distance limit	2.5 to 12 m (5 levels)	
Detectable speed	0.3 to 2.0 m / s (1.0 to 5.0 ft. / s)	
Sensitivity	2.0 °C (3.6 °F) at 0.6 m / s	
Power input	9.5 to 18 V DC	
Current draw	24 mA max. at 12 VDC	35 mA max. at 12 VDC
Alarm period	2.0 ± 0.1 sec.	
Warm-up period	Approx. 60 sec. (LED blinks)	
Alarm output	N.C. / N.O. Selectable 28 VDC 0.1 A max.	
Trouble output	N.C. 28 VDC 0.1 A max.	
Tamper output	N.C. 28 VDC 0.1 A max, open when cover removed	
LED indicator	Red LED ; 1. Warm-up 2. Alarm 3. Masking detection (DIP switch ON or Walk test)	Red LED ; 1. Warm-up 2. Alarm 3. Masking detection Yellow LED ; 1. Warm-up 2. MW detection (DIP switch ON or Walk test)
Operating temperature	-20°C to +60°C (-4°F to +140°F)	-20°C to +45°C (-4°F to +113°F)
Environment humidity	95 % max.	
International protection	IP55	
Mounting	Wall, Pole (Outdoor, Indoor)	
Mounting height	0.8 to 1.2 m (2.7 to 4.0 ft.)	
Weight	400 g (14.1 oz.)	450 g (15.9 oz.)
Accessories	Screw (4 x 20 mm) x 2, Wiring sponge x 3, Masking seal x 3	

Specifications and designs are subject to change without prior notice.

VXS-RAM/RDAM

B-ZONE

BATTERY OPERATED WIDE ANGLE OUTDOOR PIR DETECTOR



The VX Shield "R" models are battery operated products. Sharing the same design and performance with VXS-AM/DAM, "R" models have the most up-to-date outdoor protection capabilities.

- VXS-RAM – battery operated model with active IR anti-masking
- VXS-RDAM – battery operated dual technology model with active IR anti-masking

FEATURES

- Long battery life
- Active IR anti-masking
- SMDA (Super Multidimensional Analysis) logic
- Easy masking for over spill prevention
- Double conductive shielding
- Back tamper
- Automatic walk test mode

COVERAGE

TOP VIEW (Area diagram for D position)

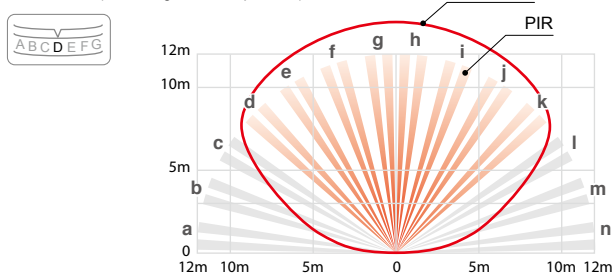

SIDE VIEW (Detection Distance by Positions)

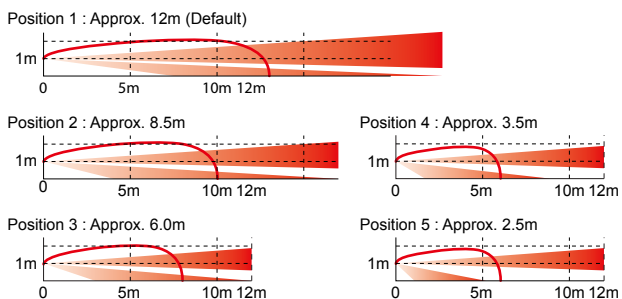

OPTIONS

- VXS face cover (White / Silver / Black)
- VXS option cover unit (Black / white)
- VXS battery box (Black/White)
- RBB-01 : Battery box

DIMENSIONS

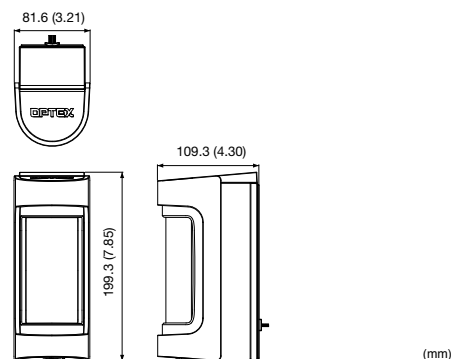

SPECIFICATIONS

Model	VXS-RAM	VXS-RDAM
Detection method	Passive infrared	Passive infrared & Microwave
PIR coverage	12 m (40 ft) 90° wide / 16 zones	
PIR distance limit	2.5 to 12 m (5 levels)	
Detectable speed	0.3 to 2.0 m / s (1.0 to 5.0 ft. / s)	
Sensitivity	2.0 °C (3.6 °F) at 0.6 m / s	
Power input	3 to 9 V DC Lithium or Alkaline Battery	
Current draw	10 μ A standby / 4 mA max. at 3 V DC	18 μ A standby / 8 mA max. at 3 V DC
Alarm period	2.0 ± 0.1 sec.	
Warm-up period	Approx. 60 sec. (LED blinks)	
Alarm output	N.C. / N.O. Selectable-Solid State Switch 10 V DC 0.01 A max.	
Trouble output	N.C. / N.O. Selectable-Solid State Switch 10 V DC 0.01 A max.	
LED indicator	Red LED ; 1. Warm-up 2. Alarm 3. Masking detection (DIP switch ON or Walk test)	Red LED ; 1. Warm-up 2. Alarm 3. Masking detection Yellow LED ; 1. Warm-up 2. MW detection (DIP switch ON or Walk test)
Operating temperature	-20°C to +60°C (-4°F to +140°F)	-20°C to +45°C (-4°F to +113°F)
Environment humidity	95 % max.	
International protection	IP55	
Mounting	Wall, Pole (Outdoor,Indoor)	
Mounting height	0.8 to 1.2 m (2.7 to 4.0 ft.)	
Weight	500 g (17.6 oz.)	550 g (19.4 oz.)
Accessories	Connector for POWER and ALARM, Connector for TROUBLE, Screw (4 x 20 mm) x 2, Masking seal x 3	

Specifications and designs are subject to change without prior notice.

OUTDOOR PROTECTION

INDOOR PROTECTION

REDWALL

ACCESS CONTROL

TECHNICAL INFORMATION

VXI-ST/AM/DAM

B-ZONE

OUTDOOR PIR DETECTOR



The VX Infinity series provide reliable intrusion detection in severe outdoor environment. Built with a top industry detection algorithm, its performance always remain optimal despite changes of day/night and seasonal environment. Newly added features and mechanism made VX Infinity more versatile and invulnerable in outdoor security system. Anti-masking and dual technology models are available in a lineup.

- VXI-ST – standard model
- VXI-AM – active IR anti-masking model
- VXI-DAM – dual technology model with active IR anti-masking
 - VXI-DAM-X5 : 10.525 GHz
 - VXI-DAM-X8 : 10.587 GHz

FEATURES

- 12 m by 90 degree flexible detection pattern adjustable to 5 ranges
- SMDA (Super Multidimensional Analysis) logic
- Easy masking for over spill prevention
- Double conductive shielding
- Conduit/TX-battery case
- Active IR digital anti-masking (VXI-AM, VXI-DAM)
- Tough mod™ dual technology based on OPTEX gold-plated microwave module (VXI-DAM)

COVERAGE

The actual detection distance is dependent on the thermal conditions within the given environment.

TOP VIEW (Area diagram for D position)

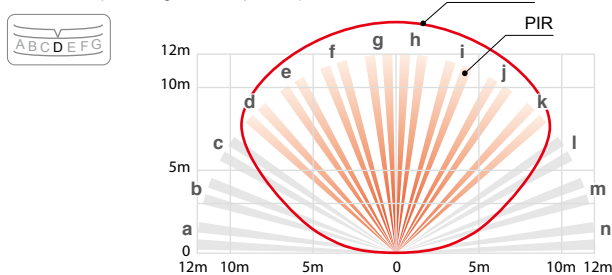

SIDE VIEW (Detection Distance by Positions)

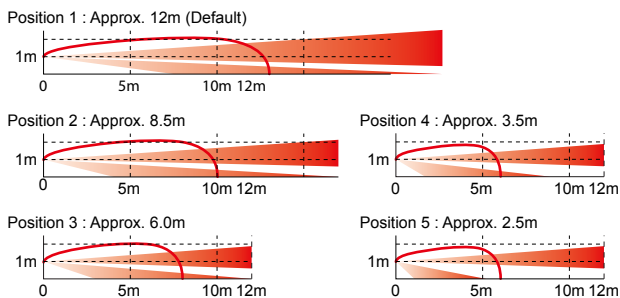

OPTIONS

- PEU-B/C/D/E/F/G/H/I/J/K : Selectable plug-in end of line unit
- VXI-T-Bracket
- WRS-02 : Wall tamper

DIMENSIONS

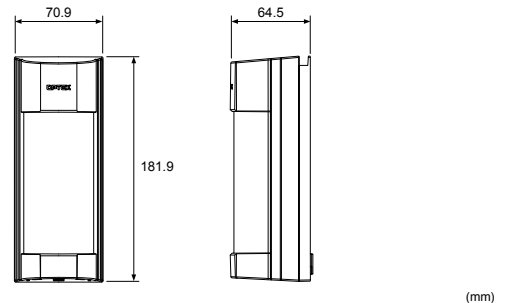

SPECIFICATIONS

Model	VXI-ST	VXI-AM	VXI-DAM
Detection method	Passive infrared		
PIR coverage	12.0 m 90° wide / 16 zones		
PIR distance limit	12 to 2.5 m (5 levels)		
Detectable speed	0.3 to 1.5 m/s		
Sensitivity	2.0°C (3.6°F) at 0.6 m/s		
Power input	9.5 to 18 VDC		
Current draw	20 mA (max) at 12 VDC	24 mA (max) at 12 VDC	35 mA (max) at 12 VDC
Alarm period	2.0 ± 1 sec.		
Warm-up period	Approx. 60 sec. (LED blinks)		
Alarm output	N.C. / N.O. Selectable 28 VDC 0.1 A (max)		
Trouble output	N.C. 28 VDC 0.1 A (max)		
Tamper output	N.C. 28 VDC 0.1 A (max) open when cover removed.		
LED indicator	Red: Warm-up, alarm, masking detection (VXI-AM only)		Red: Warm-up, alarm, masking detection. Yellow: Warm-up, MW detect.
RF interference	No alarm 10 V/m		
Operating temperature	-30 to +60°C		-20 to +45°C
Environment humidity	95% max.		
International protection	IP55		
Mounting	Wall, Pole		
Mounting height	0.8 to 1.2 m		
Weight	500 g		600 g
Accessories	Screw (4x20 mm) x2, Wiring sponge x3, Masking seal x3		

Specifications and design are subject to change without prior notice.

VXI-R/-RAM/-RDAM

B-ZONE

BATTERY OPERATED OUTDOOR PIR DETECTOR



The VX Infinity "R" models are battery operated products. Sharing the same design and performance with VXI-ST, AM, DAM, "R" models have the most up-to-date outdoor protection capabilities. Utilizing transmitters from various major brands, "R" models enable easy wireless integration of outdoor protection into new and pre-existing security system. Anti-masking and dual technology models are available in a lineup.

- VXI-R – battery operated model
- VXI-RAM – battery operated model with active IR anti-masking
- VXI-RDAM – battery operated dual technology model with active IR anti-masking
 - VXI-RDAM-X5 : 10.525 GHz
 - VXI-RDAM-X8 : 10.587 GHz

FEATURES

- 12 m by 90 degree flexible detection pattern adjustable to 5 ranges
- SMDA (Super Multidimensional Analysis) logic
- Easy masking for over spill prevention
- Double conductive shielding
- Conduit/TX-battery case for both wired and wireless-ready models
- Active IR digital anti-masking(VXI-RAM, VXI-RDAM)
- Tough mod™ dual technology based on OPTEX gold-plated microwave module (VXI-RDAM)

COVERAGE

The actual detection distance is dependent on the thermal conditions within the given environment.

TOP VIEW (Area diagram for D position)

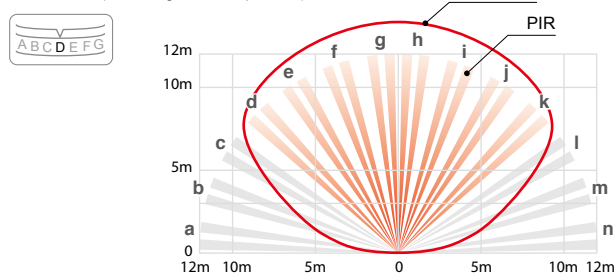

SIDE VIEW (Detection Distance by Positions)

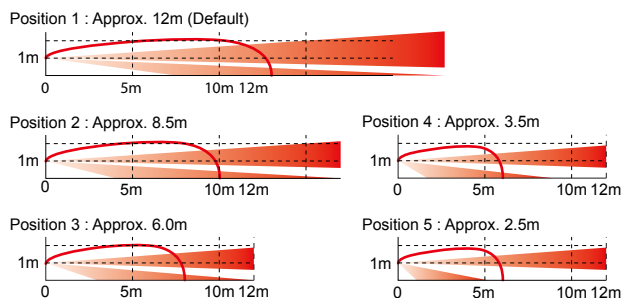

OPTIONS

- VXI-T-Bracket
- WRS-04 : Wall tamper
- RBB-01 : Battery box

DIMENSIONS

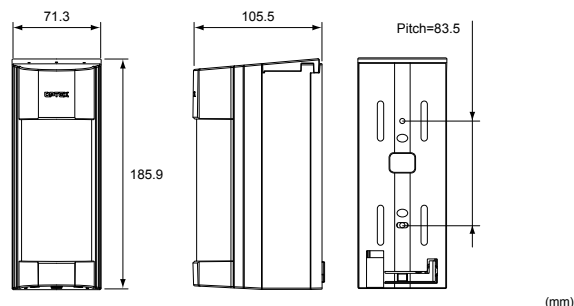

SPECIFICATIONS

Model	VXI-R	VXI-RAM	VXI-RDAM
Detection method	Passive infrared		Passive infrared & Microwave
PIR coverage	12.0 m wide / 16 zones		
PIR distance limit	12 to 2.5 m (5 levels)		
Detectable speed	0.3 to 1.5 m/s		
Sensitivity	2.0°C at 0.6 m/s		
Power input	3 to 9 VDC(Lithium or Alkaline Battery)		
Current draw	9µA (standby) / 4 mA (max) at 3 VDC	10µA (standby) / 4 mA (max) at 3 VDC	18µA (standby) / 8 mA (max) at 3 VDC
Alarm period	2.0 ±1 sec.		
Warm-up period	Approx. 60 sec. (LED blinks)		
Alarm output	N.C. / N.O. Selectable-Solid State Switch 10 VDC 0.01 A (max)		
Trouble output	N.C. / N.O. Selectable-Solid State Switch 10 VDC 0.01 A (max)		
LED indicator	Disable: During normal operation. Enable: During WALK TEST or LED SW on. Red: Warm-up, alarm, masking detection (VXI-RAM only)		Disable: During normal operation. Enable: During WALK TEST or LED SW on. Red: Warm-up, alarm, masking detection. Yellow: Warm-up, MW detect.
RF interference	No alarm 10 V/m		
Operating temperature	-20 to +60°C		-20 to +45°C
Environment humidity	95% max.		
International protection	IP55		
Mounting	Wall, Pole		
Mounting height	0.8 to 1.2 m		
Weight	500 g	600 g	
Accessories	Connector for POWER and ALARM, Connector for TROUBLE, Screw (4x20mm) x2, Masking seal x3		

Specifications and design are subject to change without prior notice.
Batteries and wireless transmitters are not included in these products.

OUTDOOR PROTECTION

INDOOR PROTECTION

RED WALL

ACCESS CONTROL

TECHNICAL INFORMATION

BXS-ST/AM

B-ZONE

BOUNDARY OUTDOOR PIR DETECTOR



COVERAGE

Top view

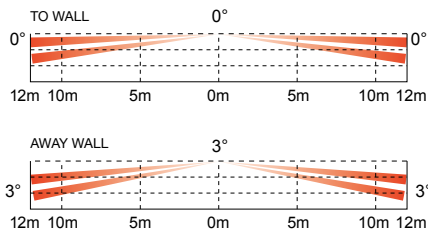

Side view

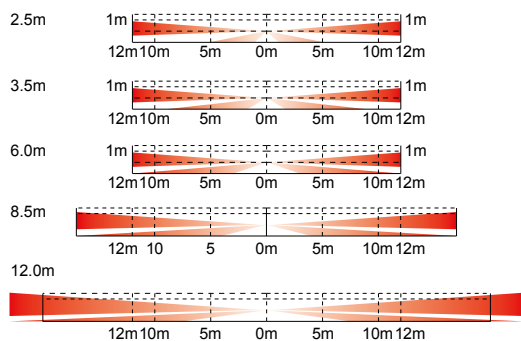

OPTIONS

- PEU-B/C/D/E/F/G/H/I/J/K : Selectable plug-in end of line unit
- BXS face cover (White / Silver / Black)
- BXS back box (Black / white)
- BXS back box cap (Black / white)
- PMP-01 : Pole mount plate

COLLAR

 Black cover /
Black body

 White cover /
black body

 Silver cover /
black body

 White cover /
white body

The BX SHIELD is a series of either side detectors providing 12 m side by side (total 24 m / 80 ft) coverage. Anti-masking model is also available in a lineup.

- BXS-ST – standard model
- BXS-AM – active IR anti-masking model

FEATURES

- 4 PIR technology 24m (80 ft.) 12 m (40 ft.) on each
- side adjustable to 5 ranges (2.5m, 3.5m, 6.0m, 8.5m, 12.0m)
- Individual detection area and sensitivity setting
- Extreme high detection mode
- SMDA (Super Multidimensional Analysis) logic for advanced temperature compensation Individual signal outputs (right / left)
- Double conductive shielding against bright light disturbance
- Back tamper
- Automatic walk test mode

DIMENSIONS

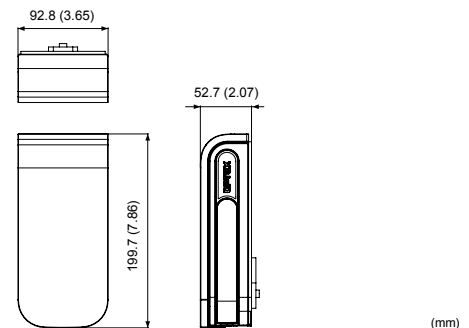

SPECIFICATIONS

Model	BXS-ST	BXS-AM
Detection method	Passive infrared	
PIR coverage	24 m (80') ; 12 m (40') on each side, 4 zones ; 2 zones on each side, 180° narrow	
PIR distance limit	list the possible range 2.5, 3.5, 6, 8.5, 12 m	
Detectable speed	0.3 to 2.0 m/s (1' to 6'7"/s)	
Sensitivity	Normal ; 2.0°C (3.6°F) at 0.6 m/s Extreme high : 1.0°C (1.8°F) at 0.6 m/s selectable for each side individually	
Power input	9.5 to 18 V DC	
Current draw	31 mA max.at 12 V DC	34 mA max.at 12 V DC
Alarm period	2.0 ± 1 sec.	
Warm-up period	60 sec. or less (LED blinks)	
Alarm output	28 V DC 0.1 A max. [Individual; Right or General], [N.O. or N.C.] are selectable	
Trouble output	-	N.C. 28 V DC 0.1 A max.
Tamper output	N.C. 28 V DC 0.1 A max. open when face cover, main unit or base unit is removed	
LED indicator	Red LED ; 1. Warm-up 2. Alarm (DIP switch ON or Walk test)	Red LED ; 1. Warm-up 2. Alarm , 3. Masking detection (DIP switch ON or Walk test)
Operating temperature	-30°C to + 60°C (-22°F to +140°F)	
Environment humidity	95% max.	
International protection	IP 55	
Mounting	Wall, pole (outdoor, indoor)	
Mounting height	0.8 to 1.2 m (2'7" to 4')	
Weight	430 g (15.2 oz.)	
Accessories	Screw (4 x 20 mm) x 2	

Specifications and designs are subject to change without prior notice.

BXS-R/RAM

B-ZONE

BATTERY OPERATED BOUNDARY OUTDOOR PIR DETECTOR



The BX Shield "R" models are battery operated products. Sharing the same design and performance with BXS-ST/AM, "R" models have the most up-to-date outdoor protection capabilities.

- BXS-R – battery operated model
- BXS-RAM – with active IR anti-masking

FEATURES

- Long battery life
- 4 PIR technology 24m (80 ft.) 12 m (40 ft.) on each side adjustable to 5 ranges (2.5m, 3.5m, 6.0m, 8.5m, 12.0m)
- Individual detection area and sensitivity setting
- Extreme high detection mode
- SMDA (Super Multidimensional Analysis) logic for advanced temperature compensation Individual signal outputs (right / left)
- Double conductive shielding against bright light disturbance
- Back tamper
- Automatic walk test mode

COVERAGE

Top view

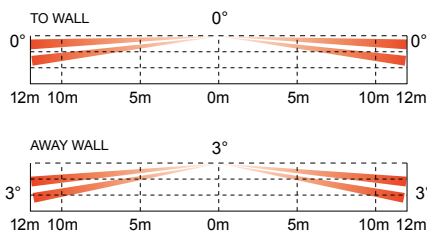

Side view

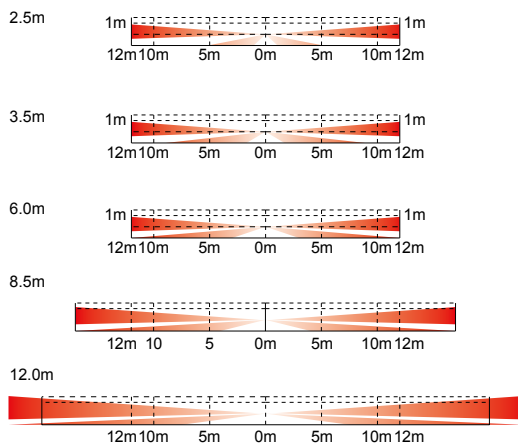

OPTIONS

- BXS face cover (White / Silver / Black)
- BXS back box (Black / white)
- BXS back box cap (Black / white)
- PMP-01 : Pole mount plate
- RBB-01 : Battery box
- BH-01 : Battery holder

DIMENSIONS

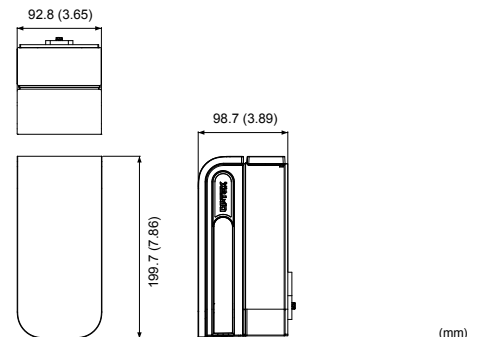

SPECIFICATIONS

Model	BXS-R	BXS-RAM
Detection method	Passive infrared	
PIR coverage	24 m (80') ; 12 m (40') on each side, 4 zones ; 2 zones on each side, 180° narrow	
PIR distance limit	2.5 to 12 m (5 levels)	
Detectable speed	0.3 to 2.0 m/s (1' to 6'7"/s)	
Sensitivity	Normal ; 2.0°C (3.6°F) at 0.6 m/s Extreme high : 1.0°C (1.8°F) at 0.6 m/s selectable for each side individually	
Power input	3 to 9 V DC Lithium or Alkaline batteries	
Current draw	15 µA stand-by / 8 mA max. at 3 V DC	16 µA stand-by / 8 mA max. at 3 V DC
Alarm period	2.0 ± 1 sec.	
Warm-up period	60 sec. or less (LED blinks)	
Alarm output	Solidstate switch, 10 V DC 0.01 A max. [Individual; Right or General], [N.O. or N.C.] are selectable	
Trouble output	Solidstate switch, 10 V DC 0.01 A max. [N.O. or N.C.] is selectable	
Tamper output	Tamper output is shared with trouble output.	
LED indicator	Red LED ; 1. Warm-up 2. Alarm (DIP switch ON or Walk test)	Red LED ; 1. Warm-up 2. Alarm , 3. Masking detection (DIP switch ON or Walk test)
Operating temperature	-30°C to + 60°C (-22°F to +140°F)	
Environment humidity	95% max	
International protection	IP 55	
Mounting	Wall, pole (outdoor, indoor)	
Mounting height	0.8 to 1.2 m (2'7" to 4')	
Weight	550 g (19.4 oz.)	
Accessories	[1] Connector for POWER and ALARM (R), [2] Connector for ALARM (L), [3] Connector for TROUBLE, [4] Velcro tape, [5] Screw (4x20 mm) x 2	

Specifications and designs are subject to change without prior notice.

BX-80N

B-ZONE

OUTDOOR PIR DETECTOR FOR BUILDING PERIMETER



The BX-80N is stylishly designed to blend in with any architecture and is simple to install and set up.

FEATURES

- Double conductive shielding
- Advanced temperature compensation
- Limited detection range function
- Size judging function to avoid false alarms
- Variable detection range up to 24m (12m on each side)
- Audible alarm function
- Attractive, slender design

COVERAGE

TOP VIEW

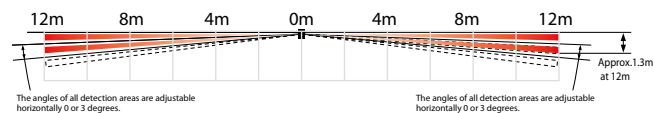

SIDE VIEW

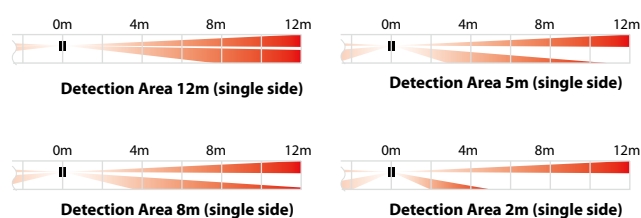

DIMENSIONS

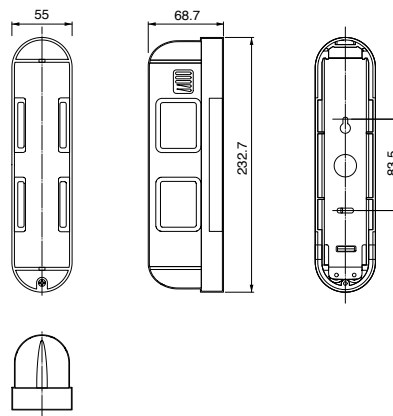

(mm)

SPECIFICATIONS

Model	BX-80N
PIR coverage	24m (12m on each side)
Detection zones	4 zones (2 zones on each side)
Sensitivity	1.6°C at 0.6m/s
Detectable speed	0.3 to 2.0m/s
Power supply	10 to 28 VDC
Current consumption	38mA (max.)
Alarm period	2 ± 1 sec.
Alarm output	2 relay outputs N.O. and N.C. 28 VDC 0.2A (max.) each
Tamper switch	N.C. opens when cover is removed
Warm-up period	Approx. 45 sec. (LED blinks)
Volume of audible alarm	Approx. 70dB (at 1 meter distance)
LED indicator	LED is blinking during warm-up period
Operating temperature	Alarm condition -20 to +50°C
Environmental humidity	95% max.
RF interference	No Alarm 20V/m
Mounting height	0.8 to 1.2 m
Mounting	Wall
Weight	400 g
Dimensions (H x W x D)	232.7 mm x 55 mm x 68.7 mm
International protection	IP55

Specifications and design are subject to change without prior notice.



OPTIONS

- MG-1 : Vandal and tamper resistant metal guard
- SP-2 : Spacer unit
- BA-1W : Multi angle wall mount bracket

OUTDOOR PROTECTION

INDOOR PROTECTION

RED WALL

ACCESS CONTROL

TECHNICAL INFORMATION

BX-80NR

B-ZONE

BATTERY OPERATED OUTDOOR PIR DETECTOR FOR BUILDING PERIMETER



The BX-80NR is quick and easy to install. This unit requires no complicated wiring as it is a battery operated PIR detector. Not only does one save on installation time and cost, but an added benefit of the unit is its slick design that blends in with any architecture.

FEATURES

- Battery saving circuit
- Form C alarm output and tamper output
- Low current draw
- Double conductive shielding
- Advanced temperature compensation
- Limited detection range function
- Size judging function to avoid false alarms
- Variable detection range up to 24m (12m on each side)
- Compatible with numerous wireless transmitters

COVERAGE

TOP VIEW

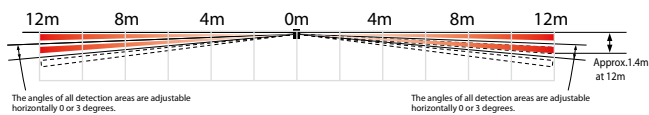

SIDE VIEW

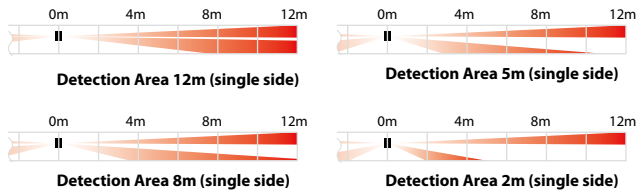

DIMENSIONS

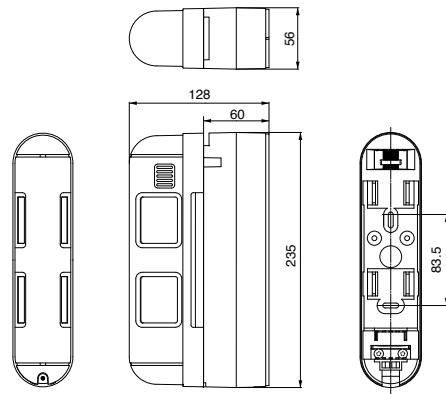

(mm)

Back box for wireless transmitters and batteries

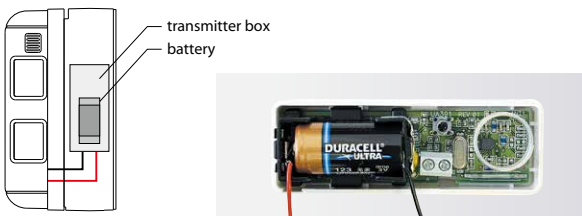

Batteries are not included with this unit.

OPTIONS

- BA-1W : Multi angle wall mount bracket

SPECIFICATIONS

Model	BX-80NR
PIR coverage	24m (12m on each side)
Detection zones	4 zones (2 zones on each side)
Sensitivity	2.0°C at 0.6m/s
Detectable speed	0.3 to 1.5m/s
Power supply	3 - 9 VDC lithium or alkaline Battery
Current consumption	3mA(Walktest, LED on) 15uA(Standby)
Alarm period	2 ± 1 sec.
Alarm output	Form C-Solid state switch: 10 VDC 0.01A
Battery saving time	Approx. 120 sec. or 5 sec.
Tamper swith	Form C activates when cover is removed
Warm-up period	Approx. 2 min.
LED indicator	Disable during normal operation Enable during walktest or LED switch on
Operating temperature	-20 to +50°C
Environmental humidity	95% max.
RF interference	No Alarm 20V/m
Mounting height	0.8 to 1.2 m
Mounting	Wall
Weight	520 g
Dimensions (H x W x D)	235 mm x 56 mm x 128 mm
International protection	IP55

Specifications and design are subject to change without prior notice. Batteries and wireless transmitters are not included in these products.

FTN-ST/AM

B-ZONE

COMPACT OUTDOOR PIR DETECTOR



FTN series offers the perfect solution for those outdoor areas where environmental disturbances and small animals may cause false alarms.

- FTN-ST – standard model
- FTN-AM – active IR anti-masking model

5m/2m switchable lens

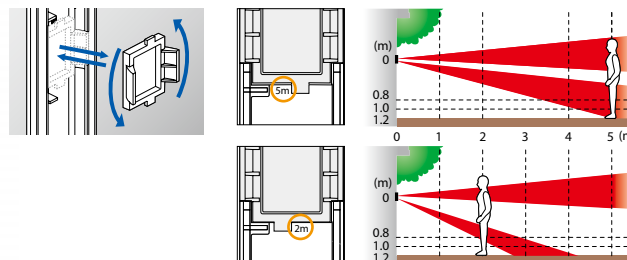

COVERAGE

TOP VIEW

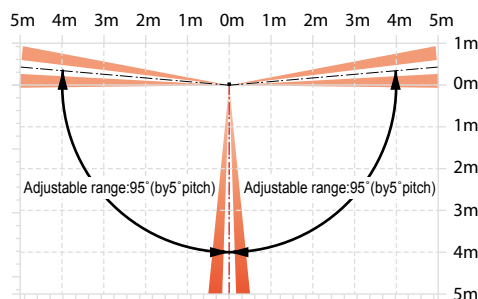

SIDE VIEW

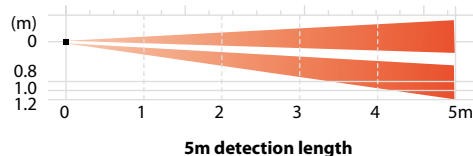
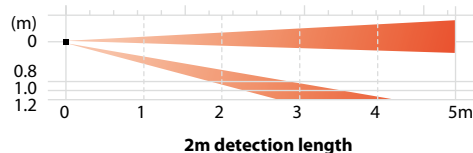

OPTIONS

- WRS-02 : Wall tamper

FEATURES

- Built in bracket (190° horizontal)
- 5m/2m switchable lens
- SMDA (Super Multidimensional Analysis) logic
- Intelligent AND detection logic
- Active IR digital anti-masking (FTN-AM)
- Wall tamper (options)

DIMENSIONS

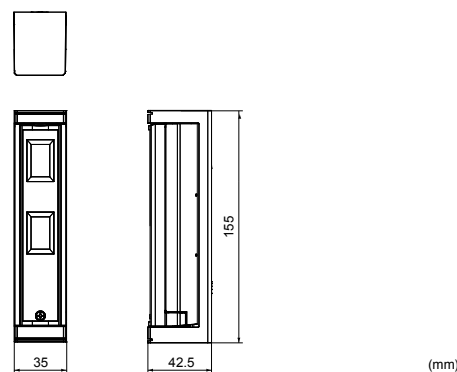

SPECIFICATIONS

Model	FTN-ST	FTN-AM
Detection method	Passive infrared	
PIR coverage	5 x 1m	
Detection length limit	2 m, 5 m	
Detectable speed	0.3 to 1.5 m/s	
Sensitivity	2.0°C (at 0.6 m/s)	
Operation voltage	9.5 to 18 VDC	
Current draw	17mA(max.) (at 12 VDC)	20mA(max.) (at 12 VDC)
Alarm period	2.0 ± 1.0sec.	
Warm-up period	Approx. 60 sec. (LED blinks)	
Alarm output	N.C./N.O. Selectable 28 VDC 0.1 A (max.)	
Trouble output	N.C. 28 VDC 0.1 A (max.), opens when the cover is removed.	
LED indicator	Light/Blink: Warm-up, alarm, masking detection (FTN-AM only)	
Operation temperature	-20 to +60°C	
Environmental humidity	95% max.	
International protection	IP55	
Mounting	Wall (Outdoor, Indoor)	
Mounting height	0.8 to 1.2 m	
Weight	100 g	
Accessories	screw (3 x 20 mm) x 2	

Specifications and design are subject to change without prior notice.

FTN-R/RAM/R-PT/RAM-PT

B-ZONE

BATTERY OPERATED COMPACT OUTDOOR PIR DETECTOR



FTN-R/RAM are battery operated outdoor PIR detector and therefore requires no complicated wiring. It saves installation time and cost.

- FTN-R – battery operated model
- FTN-RAM – battery operated model with active IR anti-masking function

Multi fixing separate box

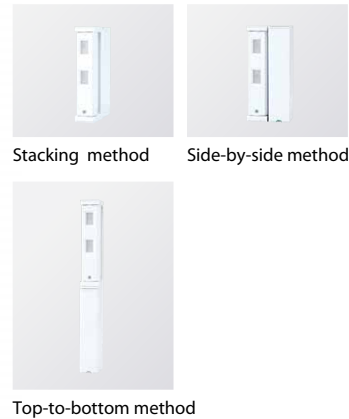

FTN-R-PT/RAM-PT



FEATURES

- Long battery life
- Built in bracket (190° horizontal)
- Active IR digital anti-masking (FTN-RAM)
- Wall tamper (options)

COVERAGE

TOP VIEW

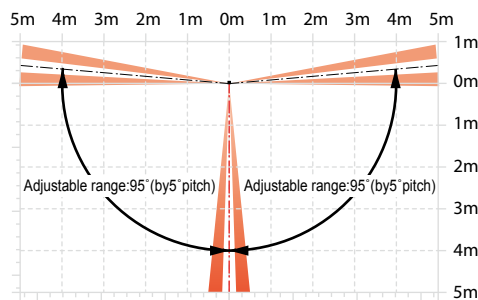

SIDE VIEW

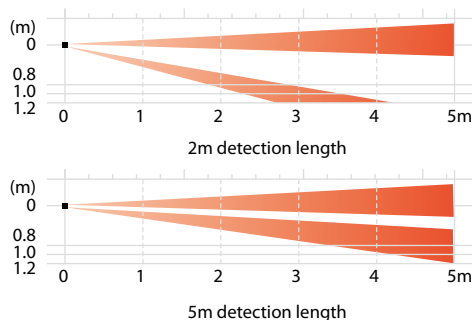

OPTIONS

- WRS-03 : Wall tamper

DIMENSIONS

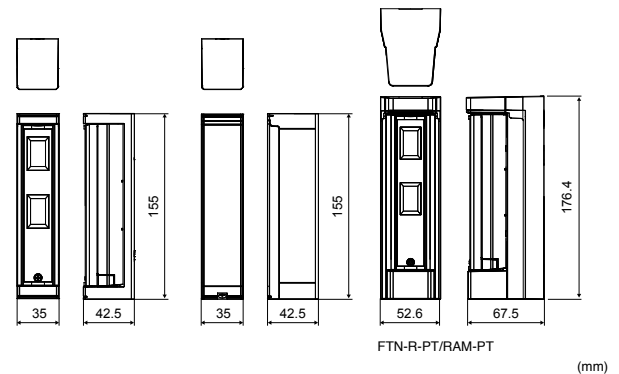

SPECIFICATIONS

Model	FTN-R	FTN-RAM
Detection method	Passive infrared	
PIR coverage	5 x 1m	
Detection length limit	2 m, 5 m	
Detectable speed	0.3 to 1.5 m/s	
Sensitivity	2.0°C (at 0.6 m/s)	
Operation voltage	2.5 to 10 VDC	
Power input	3 - 9 VDC (Lithium or Alkaline Battery)	
Current draw	9µA(at stand-by) / 3mA(max.)(at 3 VDC)	10µA(at stand-by) / 3mA(max.)(at 3 VDC)
Alarm period	2.0 ± 1.0sec.	
Warm-up period	Approx. 120 sec. (LED blinks)	
Alarm output	N.C./N.O. Selectable-Solid State Switch 10 VDC 0.01 A(max.)	
Trouble output	N.C./N.O. Selectable-Solid State Switch 10 VDC 0.01 A(max.)	
LED indicator	Enable: During DIP switch 1 (WALK TEST MODE) or DIP switch 4 (LED) ON Disable: During normal operation Light/Blink: Warm-up, alarm, masking detection (FTN-RAM only)	
Operation temperature	-20 to +60°C	
Environmental humidity	95% max.	
International protection	IP55	
Mounting	Wall (Outdoor, Indoor)	
Mounting height	0.8 to 1.2 m	
Weight	190 g (FTN-R-PT 180g)	190 g (FTN-RAM-PT 180g)
Accessories	Connector for POWER and ALARM, connector for TROUBLE, plate nut x 2, screw (M3 x 10 mm) x 2, screw (3 x 20 mm) x 4, sponge for transmitter	

Specifications and design are subject to change without prior notice. Batteries and wireless transmitters are not included in these products.

OUTDOOR PROTECTION

INDOOR PROTECTION

REDWALL

ACCESS CONTROL

TECHNICAL INFORMATION

HX-80N/NAM

B-ZONE

24M LONG AND NARROW RANGE HIGH MOUNT OUTDOOR PIR DETECTOR



HX-80N's coverage can be adjusted by mean of built-in flaps and plates.

Flaps for long distance limit

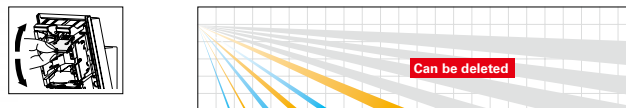

Plates for short range masking

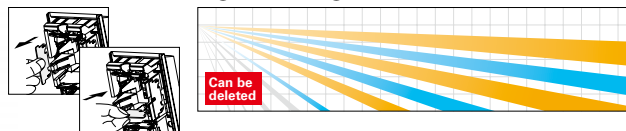

FEATURES

- Mounting height 2.5-3.0m
- Intelligent AND detection logic
- Double conductive shielding
- Advanced temperature compensation logic
- Summer night compensation logic
- Vegetation sway analysis logic
- Active IR digital anti-masking (HX-80NAM)

COVERAGE

TOP VIEW

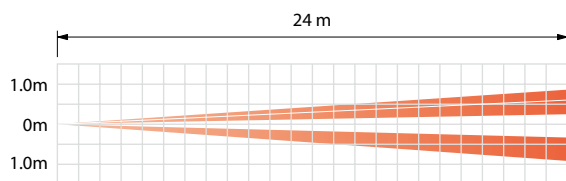

SIDE VIEW

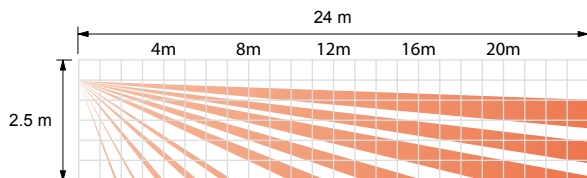
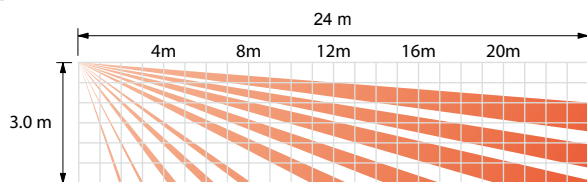

DIMENSIONS

Using bracket

Without bracket

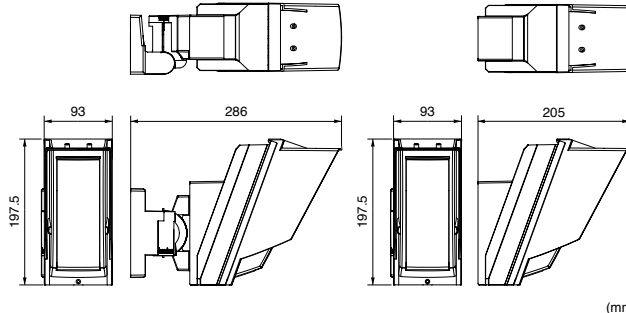

SPECIFICATIONS

Model	HX-80N	HX-80NAM
Detection method	Passive infrared	
Anti-masking	-	Active IR
PIR coverage	24.0 m x 2.0 m narrow / 20 zones	
PIR distance limit	6.5 m, 10.0 m, 13.0 m, 18.0 m	
Detectable speed	0.3 to 1.5 m/s	
Sensitivity	2.0° C at 0.6 m/s	
Power input	9.5 to 18 VDC	
Current draw	35 mA (max.) at 12 VDC	40 mA (max.) at 12 VDC
Alarm period	2.0 ± 1 sec.	
Warm-up period	Approx. 60 sec. (LED blinks)	
Alarm output	Form C 28 VDC 0.2 A (max.)	
Tamper output	N.C. 28 VDC, 0.1 A (max.) N.C. opens when cover removed.	
Trouble output	-	N.C. 28 VDC, 0.1 A (max.)
Aux input	N.C. 28 VDC, 0.1 A (max.)	
LED indicator	Red: Warm-up, Alarm	Red: Warm-up, Alarm, Trouble
RF interference	No alarm 10 V/m	
Operating temperature	-20 to +60° C	
Environmental humidity	95% max.	
International protection	IP55	
Mounting	Wall	
Mounting height	2.5 to 3.0 m	
Bracket adjust angle	Vertical: ± 20° Horizontal: ± 95°	
Weight	720 g	
Accessories	Bracket, Screw (4 x 20 mm) x 4	

Specifications and designs are subject to change without prior notice.

HX-80NRAM

B-ZONE

BATTERY OPERATED 24M LONG AND NARROW RANGE HIGH MOUNT OUTDOOR PIR DETECTOR



The HX-80NRAM, a battery operated outdoor PIR detector allows for long distance outdoor installation, providing while exceptional detection capabilities.



Battery box for numerous battery types

CR123A x 3
(3.0VDC)



CR2 x 3
(3.0VDC)



1/2AA x 3
(3.6VDC)



1/2AA x 6
(7.2VDC x 3)*



*3.6 VDC 1/2 AA battery in series.

FEATURES

- Long battery life
- Active IR digital anti-masking
- Mounting height 2.5-3.0m
- Intelligent AND detection logic
- Double conductive shielding
- Advanced temperature compensation logic
- Summer night compensation logic
- Vegetation sway analysis logic

DIMENSIONS

Using bracket

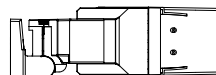

Without bracket

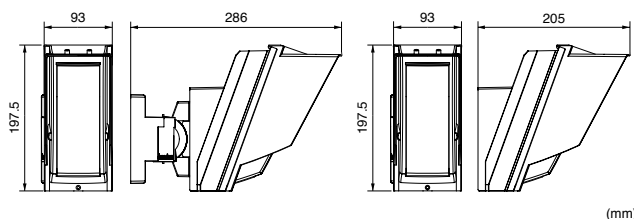

(mm)

COVERAGE

TOP VIEW

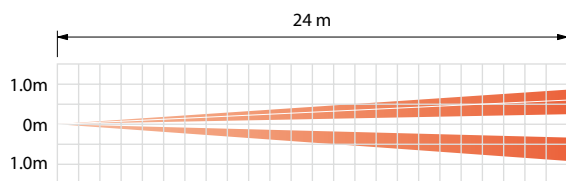

SIDE VIEW

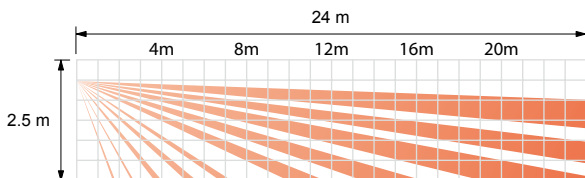
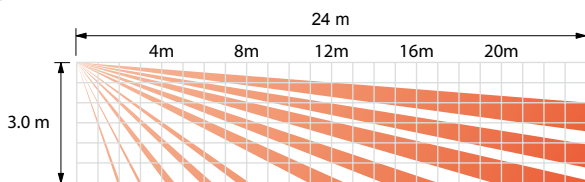

SPECIFICATIONS

Model	HX-80NRAM
Detection method	Passive infrared
Anti-masking	Active IR
PIR coverage	24.0 m x 2.0 m narrow / 20 zones
PIR distance limit	6.5 m, 10.0 m, 13.0 m, 18.0 m
Detectable speed	0.3 to 1.5 m/s
Sensitivity	2.0°C at 0.6 m/s
Power input	3 - 7.2 VDC Lithium Battery (CR123A x 3, CR2 x 3, 1/2AA x 3, 1/2AA x 6)
Operating voltage	2.5 to 9VDC
Current draw	30µA (standby) / 4 mA (max.) at 3 VDC
Alarm period	2.0 ± 1 sec.
Warm-up period	Approx. 90 sec. (LED blinks)
Alarm output	Form C -Solid State Switch- 10 VDC 0.01 A max.
Trouble output	N.C./N.O. Selectable -Solid State Switch- 10 VDC 0.01 A max.
Tamper output	Form C. 28 VDC, 0.1 A max. activates when cover removed.
LED indicator	Disable: During normal operation. Enable: During WALK TEST or LED SW on. Red: Warm-up, Alarm, Trouble, Low battery
RF interference	No alarm 10 V/m
Operating temperature	-20 to +60°C
Environmental humidity	95% max.
International protection	IP55
Mounting	Wall
Mounting height	2.5 to 3.0 m
Bracket adjust angle	Vertical: ±20° Horizontal: ±95°
Weight	780 g
Accessories	Bracket, Screw (4 x 20 mm) x 4, Velcro tape x 2, Alarm cable, Battery lead x 2, Dummy battery kit

Specifications and designs are subject to change without prior notice. Batteries and wireless transmitters are not included in these products.

OUTDOOR PROTECTION

INDOOR PROTECTION

REDWALL

ACCESS CONTROL

TECHNICAL INFORMATION

HX-40/AM/DAM

B-ZONE

HIGH MOUNT OUTDOOR PIR DETECTOR



HX-40 series offers high detection performance against missed alarms in a hostile environment.

- HX-40 : standard model
- HX-40AM : active IR anti-masking model
- HX-40DAM : dual technology model with active IR anti-masking
 - HX-40DAM-X5 : 10.525 GHz
 - HX-40DAM-X8 : 10.587 GHz

Intelligent AND detection Logic

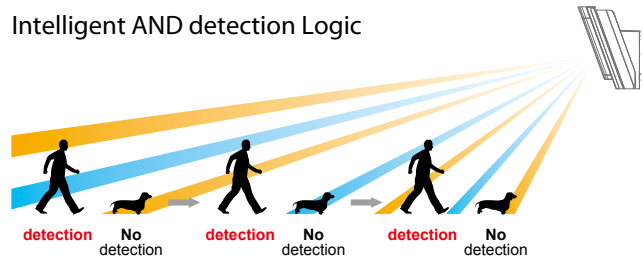

FEATURES

- Active IR digital anti-masking (HX-40AM/DAM only)
- Microwave Intelligent quantification logic (HX-40DAM only)
- Microwave range selector (HX-40DAM only)
- Mounting height 2.5-3m
- Intelligent AND detection logic
- Dual signal processing circuit
- Vegetation sway analysis logic
- Double conductive shielding
- Ideal detection area setting

COVERAGE

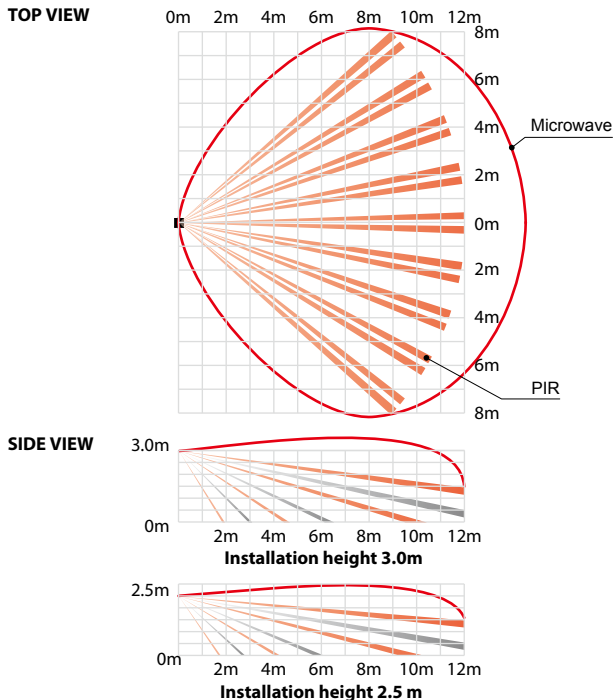

DIMENSIONS

Using bracket and hood

Without bracket and hood

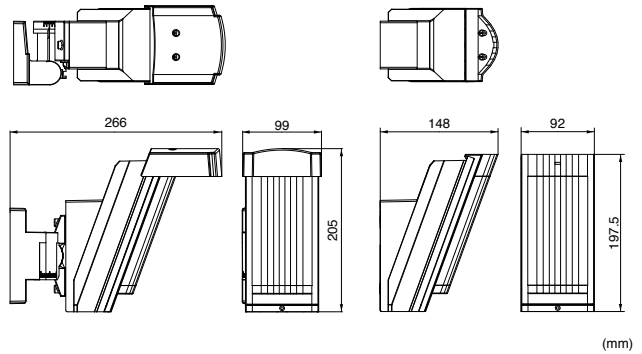

SPECIFICATIONS

Model	HX-40	HX-40 AM	HX-40 DAM
Detection method	Passive infrared		Passive infrared & Microwave
Anti-masking	-	Active IR	
PIR coverage	12 m 85° wide / 94 zones		
PIR distance limit	4 m, 5.5 m, 9 m		
Detectable speed	0.3 to 1.5 m/s		
Sensitivity	2.0°C at 0.6 m/s		
Power input	9.5 to 18 VDC		
Current draw	35 mA (max) at 12 VDC	40 mA (max) at 12 VDC	50 mA (max.) at 12 VDC
Alarm period	2.0 ± 1 sec		
Warm-up period	Approx. 60 sec(LED blinks)		
Alarm output	Form C 28 VDC 0.2A max		
Tamper output	N.C. 28 VDC, 0.1A max. N.C. opens when cover is removed.		
Trouble output	N.C. 28 VDC, 0.1A max		
Aux input	-	N.C. 28 VDC, 0.1A max	
LED indicator	Red:Warm-up, Alarm		Red:Warm-up, Alarm, Trouble Green:Warm-up, PIR detect, Trouble Yellow:Warm-up, MW detect
RF interference	No alarm 10 V/m		
Operating temperature	-20 to +60°C		
Environmental humidity	95% max		
International protection	IP55		
Mounting	Wall		
Mounting height	2.5 to 3.0 m		
Bracket adjust angle	Vertical: ±20° Horizontal: ± 95°		
Weight	600 g		700 g
Accessories	Bracket, Hood, Area masking seal, Screw kit (3 x 10-2, 4 x 20-4)		

Specifications and design are subject to change without prior notice.

Microwave ranges are for HX-40DAM.

HX-40RAM

B-ZONE

BATTERY OPERATED HIGH MOUNT OUTDOOR PIR DETECTOR WITH ANTI-MASKING FUNCTION



The HX-40RAM, a battery operated outdoor PIR detector allows for economical and effortless outdoor installation, providing while exceptional detection capabilities.

Battery box for numerous battery types



CR123A x 3
(3.0VDC)



CR2 x 3
(3.0VDC)



1/2AA x 3
(3.6VDC)



1/2AA x 6
(7.2VDC x 3)*



*3.6 VDC 1/2 AA battery in series.

FEATURES

- Long battery life
- Form C alarm output and tamper output
- Battery saving timer function
- Active IR digital anti-masking
- Mounting height 2.5-3m
- Intelligent AND detection logic
- Dual signal processing circuit
- Vegetation sway analysis logic
- Double conductive shielding
- Ideal detection area setting

DIMENSIONS

Using bracket and hood

Without bracket and hood

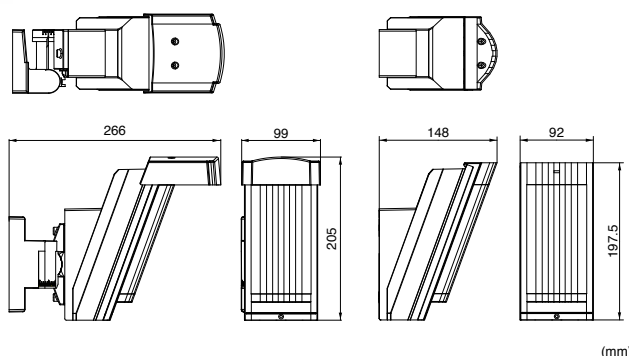

COVERAGE

TOP VIEW

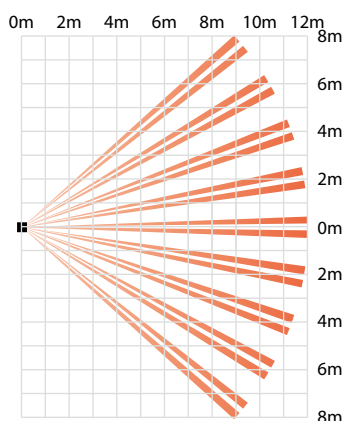

SIDE VIEW

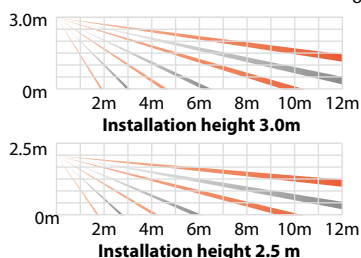

SPECIFICATIONS

Model	HX-40 RAM
Detection method	Passive infrared
Anti-masking	Active IR
PIR coverage	12 m 85° wide / 94 zones
Distance limit	4 m, 5.5 m, 9 m
Detectable speed	0.3 to 1.5 m/s
Sensitivity	2.0°C at 0.6 m/s
Power input	3 to 7.2 VDC Lithium Battery (CR123A x 3, CR2 x 3, 1/2AA x 3, 1-2AA x 6)
Operating Voltage	2.5 to 9 VDC
Current draw	30 µA (standby) / 4mA (max) at 3 VDC
Alarm period	2.0 ± 1 sec
Warm-up period	Approx. 90 sec(LED blinks)
Alarm output	Form C - Solid State Switch - 10 VDC 0.01A max.
Trouble output	N.C./N.O. Selectable - Solid State Switch - 10 VDC 0.01A
Tamper output	Form C. 28 VDC, 0.1A max. changes when cover is removed
Aux input	-
LED indicator	Disable : During normal operation. Enable : During WALK TEST or LED SW on. Red : Warm-up, Alarm, Trouble, Low battery
RF Interference	No alarm 10 V/m
Operating temperature	-20 to +60°C
Environmental humidity	95% max
International protection	IP55
Mounting	Wall
Mounting height	2.5 to 3.0 m
Bracket adjust angle	Vertical: ± 20° Horizontal: ± 95°
Weight	600 g
Accessories	Bracket, Hood, Area masking seal, Screw kit (3 x 10-2, 4 x 20-4) Velcro tape x 2, Alarm cable, Battery lead x 2, Dummy battery kit

Specifications and design are subject to change without prior notice.
Batteries and wireless transmitters are not included in these products.

OUTDOOR PROTECTION

INDOOR PROTECTION

REDWALL

ACCESS CONTROL

TECHNICAL INFORMATION

QXI-ST/DT

B-ZONE

WIDE ANGLE OUTDOOR PIR DETECTOR

OUTDOOR PROTECTION

INDOOR PROTECTION

REDWALL

ACCESS CONTROL

TECHNICAL INFORMATION



The QXI series is a family of outdoor detectors providing 120 degree wide and 12 m (40 ft.) detection area. With its sleek and compact housing, the QX Infinity series fits any residential and commercial buildings without ruining its appearance.

- QXI-ST - standard model
- QXI-DT - dual technology model

FEATURES

- Sleek & Compact design
- Selectable Mounting Height & Pattern
- Anti-blocking Function (QXI-DT only)
- Easy Open and Close Front Cover
- Double Conductive Shielding
- SMDA (Super Multi Dimension Analysis) logic
- Operating Temperature:
QXI-ST/R:-40 to +60°C (-40 to +140°F) /
QXI-DT/RDT:-40 to +45°C (-40°F to +113°F)
- UV Resistant ASA body
- Automatic Walk Test Mode
- Tough MOD : super tough microwave module (QXI-DT only)
- Cover / Back tamper

COVERAGE

TOP VIEW

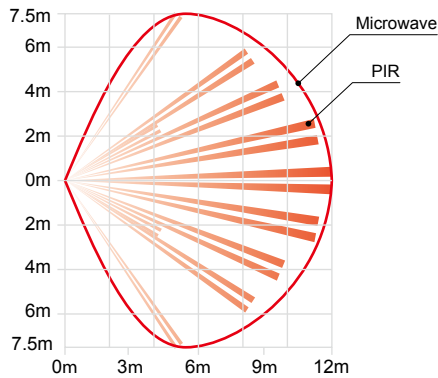

SIDE VIEW (Multi Level)

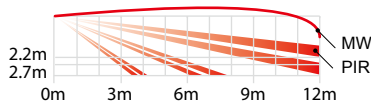

SIDE VIEW (Pet Alley)

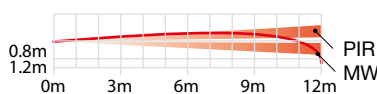

OPTIONS

- CA-2C(W) : Multi angle ceiling mount bracket
- CA-1W(W) : Multi angle wall mount bracket

DIMENSIONS

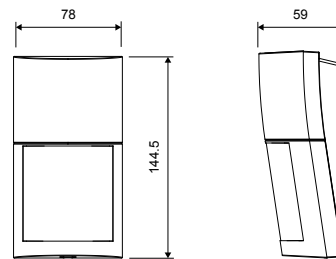

(mm)

SPECIFICATIONS

Model	QXI-ST	QXI-DT
Detection method	Passive infrared	
PIR coverage	12.0 m (40') 120°wide	
Detectable speed	0.3 to 2.0 m/s (1' to 6'7"/s)	
Sensitivity	2.0°C (3.6°F) at 0.6 m/s	
Power input	9.5 to 16 VDC	
Current draw	20 mA max. at 12 VDC	30 mA max. at 12 VDC
Alarm period	2.0 ± 0.5 sec. (delay timer)	
Warm-up period	Approx. 60 sec. (LED blinks)	
Alarm output	N.C/N.O. switchable, 28 VDC 0.1 A max.	
Trouble output	-	N.C. 28 V DC 0.1 A max.
Tamper output	N.C. 28 VDC 0.1 A max. Open when the cover is opened	
LED indicator	[1] Warm-up [2] Alarm [3] Walk test end	[1] Warm-up [2] Alarm [3] Walk test end [4] Blocking detection
Operating temperature	-40°C to +60°C (-40°F to +140°F)	-40°C to +45°C (-40°F to +113°F)
Environment humidity	95% max.	
International protection	IP54	
Mounting	Wall, Ceiling (Outdoor, Indoor)	
Mounting height	Multi level : 2.2 to 2.7 m (7' 3" to 8'11") / Pet alley : 0.8 to 1.2 m (2' 7" to 4')	
Weight	180 g (6.35 oz)	195 g (6.88 oz)
Accessories	[1] Mounting screw (4 x 12 mm) x 2 [2] Lock screw (3 x 12 mm) x 1 [3] Area masking strips	

Specifications and design are subject to change without prior notice.

QXI-R/RDT

B-ZONE

BATTERY OPERATED WIDE ANGLE OUTDOOR PIR DETECTOR



The QX Infinity "R" models are battery operated products. Sharing the same design and performance with QXI-ST/DT, "R" models have the most up-to-date outdoor protection capabilities.

- QXI-R – battery operated model
- QXI-RDT – battery operated dual technology model

FEATURES

- Sleek & Compact design
- Selectable Mounting Height & Pattern
- Anti-blocking Function
- Easy Open and Close Front Cover
- Double Conductive Shielding
- SMDA (Super Multi Dimension Analysis) logic
- Operating Temperature: QXI-ST/R: -40 to +60°C (-40 to +140°F) / QXI-DT/RDT: -40 to +45°C (-40°F to +113°F)
- UV Resistant ASA body
- Automatic Walk Test Mode
- Battery Common Use
- Tough MOD : super tough microwave module (QXI-RDT only)
- Cover / Back tamper

COVERAGE

TOP VIEW

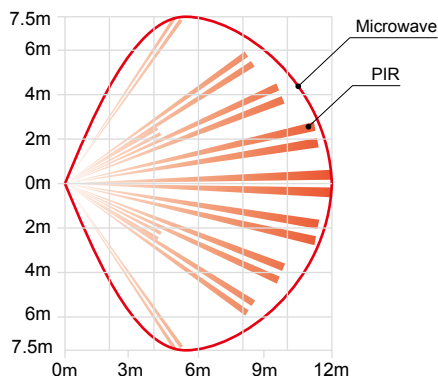

SIDE VIEW (Multi Level)

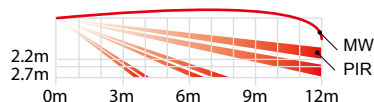

SIDE VIEW (Pet Alley)

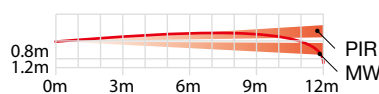

OPTIONS

- CA-2C(W) : Multi angle ceiling mount bracket
- CA-1W(W) : Multi angle wall mount bracket

DIMENSIONS

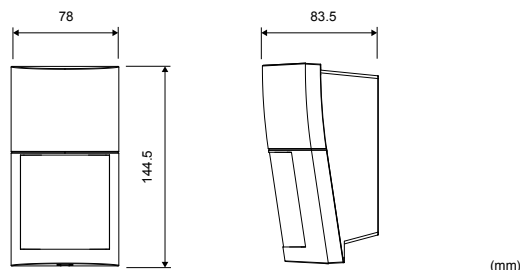

SPECIFICATIONS

Model	QXI-R	QXI-RDT
Detection method	Passive infrared & Microwave	
PIR coverage	12.0 m (40') 120°wide	
Detectable speed	0.3 to 2.0 m/s (1' to 6'7"/s)	
Sensitivity	2.0°C (3.6°F) at 0.6 m/s	
Power input	CR123A (3 V DC) *Not included	
Current draw	9 µA stand-by 11 mA max. at 3 V DC	16µA stand-by 11 mA max. at 3 V DC
Alarm period	2.0 ± 0.5 sec. (delay timer)	
Warm-up period	Approx. 60 sec. (LED blinks)	
Alarm output	N.C/N.O. switchable solidstate switch, 3 V DC 0.01 A max.	
Trouble output (with tamper)	N.C/N.O. switchable solidstate switch, 3 V DC 0.01 A max. (with tamper)	
LED indicator	[1] Warm-up [2] Alarm [3] Walk test end	
Operating temperature	-40°C to +60°C (-40°F to +140°F)	-40°C to +45°C (-40°F to +113°F)
Environment humidity	95% max.	
International protection	IP54	
Mounting	Wall, Ceiling (Outdoor, Indoor)	
Mounting height	Multi level : 2.2 to 2.7 m (7' 3" to 8'11") / Pet alley : 0.8 to 1.2 m (2' 7" to 4')	
Weight	215 g (7.58 oz)	230 g (8.11 oz)
Accessories	[1] Dummy battery and connector for ALARM [2] Connector for TROUBLE [3] Mounting screw (4 x 12 mm) x 3 [4] Lock screw (3 x 12 mm) x 1 [5] Area masking strips	

Specifications and design are subject to change without prior notice.

LX-402/802N

B-ZONE

OUTDOOR PIR DETECTOR



The LX series is robust, weatherproof and specifically designed for short-range outdoor applications with wide angle and long range options.

- LX-402 – 120° wide angle model
- LX-802N – long and narrow range model



LX-802N

FEATURES

- Double conductive shielding
- Selectable detection patterns (pet alley or multi-level)
- Area-masking strips (LX-402)
- Sensitivity selection switch (high, mid and low)
- Selectable pulse count (test or 2)
- Day & night modes

COVERAGE

TOP VIEW

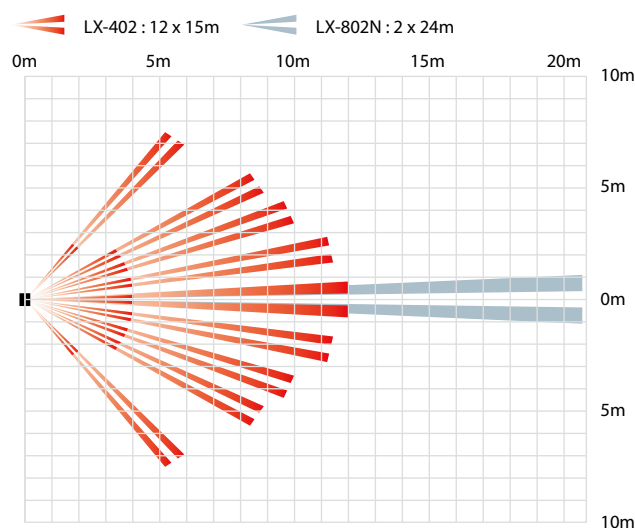

SIDE VIEW

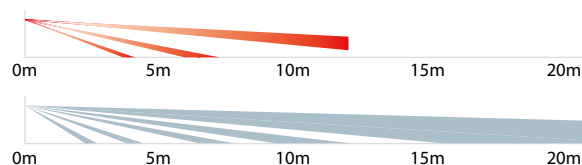

OPTIONS

- CA-2C : Multi-angle ceiling mounting bracket
- CA-1W : Multi-angle wall mounting bracket

DIMENSIONS

LX-402

LX-802N

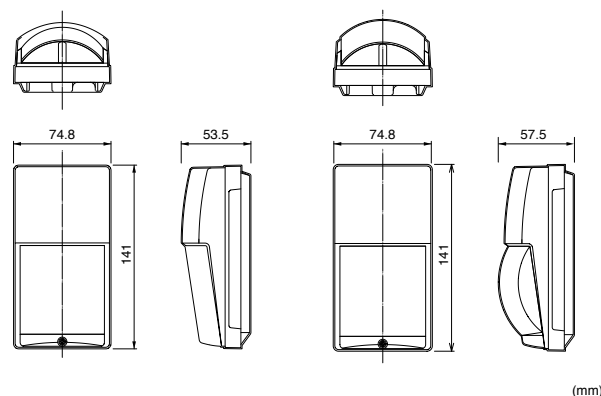

(mm)

SPECIFICATIONS

Model	LX-402	LX-802N
PIR coverage	12m x 15m 120° wide	24m x 2m long range
Detection zones	Multi-level area	40 zones
	Pet alley area	12 zones
Sensitivity	18 zones	4 zones
	Selectable 3 position (High / Middle / Low)	
Detectable speed	0.3 to 1.0m/sec.	
Power supply	10.8 to 13.2 VDC	
Current consumption	25mA max.	
Alarm period	2 ± 1 sec. (delay timer)	
Alarm output	N.C. N.O. 28 VDC 0.2A max.	
Tamper switch	N.C. opens when cover is removed	
Pulse count	2 (20 ± 5 sec.) or TEST (1 pulse)	
Warm-up period	Approx. 60 sec.	
LED indicator	LED lights during detection	
Operating temperature	-20 to +50°C	
Environmental humidity	95% max.	
Mounting height	Multi-level area	2.5 m max.
	Pet alley area	1.2 to 1.5 m
Mounting	Wall	
Weight	170 g	190 g
Dimensions (H x W x D)	141 mm x 74.8 mm x 53.5 mm	141 mm x 74.8 mm x 57.5 mm
International protection	IP54	

Specifications and design are subject to change without prior notice.

BX-100PLUS

B-ZONE

PHOTOELECTRIC DETECTOR FOR BUILDING PERIMETER



The BX-100PLUS consists of a pair of small, discreet dual infrared beams designed to protect the immediate perimeter of a building.



White decorative cover
WC-1 (Option)

FEATURES

- Dual IR pulsed beam system
- Internal sounder
- Easy alignment with visual and audible indicator
- Light reduction filter
- 99% beam blocking stability
- N.O. and N.C. relay outputs
- Active infrared technology
- Slim design

RANGES

detection range	5	10	15	20	25	30	m
allowable height	30	40	50	50	50	50	cm

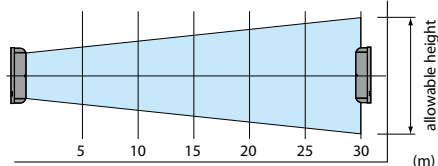

OPTIONS

- SP-1 : Spacer unit
- MG-1 : Vandal and tamper resistant metal guard
- WC-1 : White decorative cover

DIMENSIONS

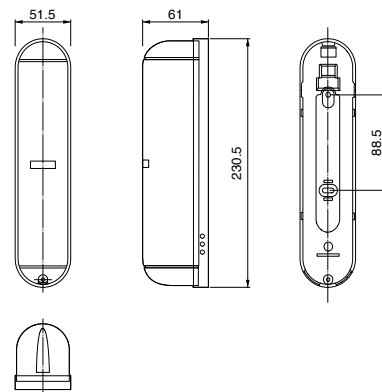

(mm)

APPLICATIONS

Retail



Business



Residential

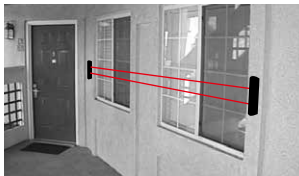

Industrial



SPECIFICATIONS

Model	BX-100PLUS
Maximum detection range	30m
Maximum arrival distance	300m
Interruption period	50 msec.
Power supply	10.5 to 28 VDC
Current consumption (transmitter + receiver)	55mA (stand by) / 75mA (max.)
Alarm period	2 ± 1 sec. (delay)
Relay output	2 relay outputs N.O. and N.C. 28 VDC 0.2A (max.) each
Beeping period	15 ± 1 sec. (delay)
Volume of audible alarm indicator	Approx. 70dB (at 1 meter distance)
Tamper switch	N.C. opens when cover is removed
Operating temperature	-35 to +55°C
Environmental humidity	95% max.
Alignment angle	± 92° Horizontal
Mounting	Wall
Weight (transmitter+receiver)	400 g
Dimensions (H x W x D)	230.5 mm x 51.5 mm x 61 mm
International protection	IP54

Specifications and design are subject to change without prior notice.

OPTIONS

CA-2C

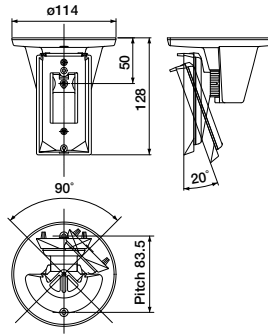

Multi Angle Ceiling Mount Bracket for
 • LX-402/802N
 • QXI-ST/DT/R/RDT

(mm)

CA-1W

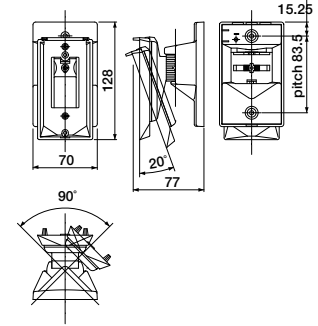

Multi Angle Wall Mount Bracket for
 • LX-402/802N
 • QXI-ST/DT/R/RDT

(mm)

VXI-T-BRACKET

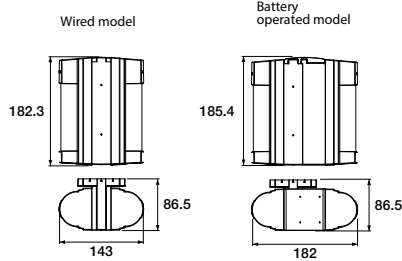
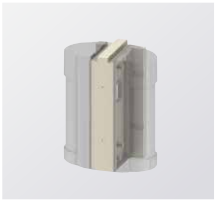

T-bracket for
 • VXI-ST/AM
 • VXI-R/RAM

(mm)

RBB-01

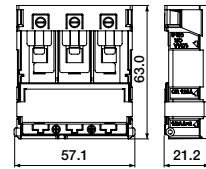

Battery Box for
 • VXI-R/RAM/RDAM
 • BXS-R/RAM

(mm)

WRS-02



Wall Tamper for
 • FTN-ST/AM
 • VXI-ST/AM/DAM

WRS-03



Wall Tamper for
 • FTN-R/RAM/R-PT/RAM-PT

WRS-04



Wall Tamper for
 • VXI-R/RAM/RDAM

PMP-01



Pole mount plate for
 • WXI-ST/AM
 • WXI-R/RAM
 • BXS-ST/AM
 • BXS-R/RAM

BH-01



Battery holder for
 • WXI-R/RAM
 • VXI-RAM/RDAM
 • BXS-R/RAM

WXI-BB



Back box for
 • WXI-ST/AM
 • WXI-R/RAM

MKP-01

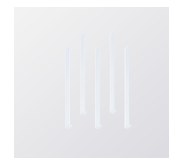

Area masking plate for
 • WXI-ST/AM
 • WXI-R/RAM

BXS Face cover



White / Silver / Black for
 • BXS-ST/AM
 • BXS-R/RAM

BXS Back box



White / Black for
 • BXS-ST/AM
 • BXS-R/RAM

BXS Back box Cap

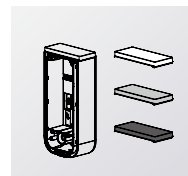

White / Silver / Black for
 • BXS-ST/AM
 • BXS-R/RAM

WC-1



White Decorative Cover
for
• BX-100PLUS

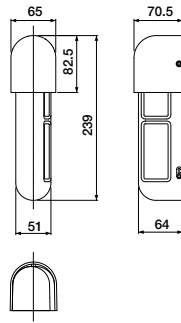

(mm)

SP-2



Spacer Unit
for
• BX-80N

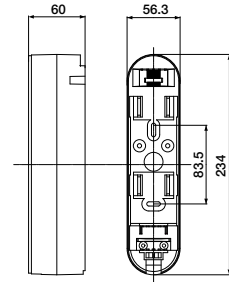

(mm)

SP-1



Spacer Unit
for
• BX-100PLUS

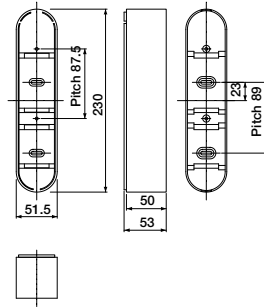

(mm)

BA-1W



Multi Angle Wall Mount
Bracket
for
• BX-80N*
• BX-80NR

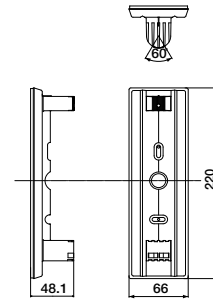

(mm)

*SP-2 spacer is required when BA-1W is used

MG-1



Vandal and Tamper Resistant
Metal Guard
for
• BX-80N
• BX-100PLUS

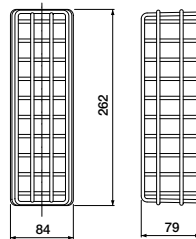

(mm)

PEU-B/C/D/E/F/G/H/I/J/K

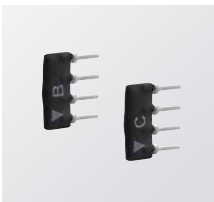

Selectable Plug-in End of
Line Unit
for
• WXI-ST/AM
• VXS-AM/DAM
• VXI-ST/AM/DAM
• BXS-ST/AM
• WXS-AM/DAM/RAM/RDAM

Item	Trouble	Alarm	Tamper	Panels
PEU-B	6.8K	4.7K	4.7K	Old GE/Artech
PEU-C	12.0K	1.0K	1.0K	Honeywell Galaxy (U.K.)
PEU-D	3.0K	1.0K	1.0K	Honeywell Galaxy (Benelux)
PEU-E	15.0K	1.1K	1.1K	Satel
PEU-F	5.6K	5.6K	5.6K	DSC, Ksenia
PEU-G	8.2K	8.2K	8.2K	Guardall
PEU-H	2.2K	4.7K	2.2K	Old Texecom, Cooper, Scantronics etc.
PEU-I	1.0K	3.3K	3.3K	New Texecom, NetworX, Inim
PEU-J	12.0K	6.8K	4.7K	Risco ProSYS
PEU-K	2.2K	1.0K	1.0K	Siemens SPC

No warranty is given as to the fitness of this option with noted above manufacture's product.
Please check on specifications of a control panel before you buy this option.
Some models do not have a trouble output.

PRODUCT SPECIFICATIONS





OUTDOOR PROTECTION





INDOOR PROTECTION





REDWALL





ACCESS CONTROL

TECHNICAL INFORMATION

	WXS-AM/DAM	WXS-RAM/RDAM	WXI-ST	WXI-AM
				
	P18	P19	P20	P20
Detection method	WXS-AM : PIR WXS-DAM : PIR & MW	WXS-RAM : PIR WXS-RDAM : PIR & MW	PIR	PIR
Anti-Masking Coverage	✓ 180° wide	✓ 180° wide	— 180° wide	✓ 180° wide
Detection zones	Horizontal 14 pairs, vertical 2 layers	Horizontal 14 pairs, vertical 2 layers	Horizontal 14 pairs, vertical 2 layers	Horizontal 14 pairs, vertical 2 layers
Mounting height	0.8 - 1.2m	0.8 - 1.2m	0.8 - 1.2m	0.8 - 1.2m
Double-layered detection patterns	✓	✓	✓	✓
Intelligent AND detection logic	✓	✓	✓	✓
Pet immunity	✓	✓	✓	✓
SMDA logic	✓	✓	✓	✓
Immunity switch	—	—	—	—
Area masking method	Shutter / Plate	Shutter / Plate	Shutter / Plate	Shutter / Plate
Double conductive shielding	✓	✓	✓	✓
Sensitivity adjustment	H / M / L	H / M / L	H / M / L	H / M / L
Advanced temperature compensation logic	✓	✓	✓	✓
Pulse Count	1 / 2	1 / 2	1 / 2	1 / 2
Power supply	9.5 - 18 VDC	9.5 - 18 VDC	9.5 - 18 VDC	9.5 - 18 VDC
Current consumption	23 mA max. at 12 VDC 24 mA max. at 12 VDC	19 µA standby by 4 mA max. at 3 VDC 24 µA standby by 6 mA max. at 3 VDC	21 mA max. at 12 VDC	23 mA max. at 12 VDC
Alarm output	28 VDC 0.1 A max. [Individual;Right/Left or General], [N.O. or N.C.] are selectable	10 VDC 0.01 A max. [Individual;Right/Left or General], [N.O. or N.C.] are selectable	28 VDC 0.1 A max. [Individual;Right/Left or General], [N.O. or N.C.] are selectable	28 VDC 0.1 A max. [Individual;Right/Left or General], [N.O. or N.C.] are selectable
Alarm indication LED	✓	✓	✓	✓
Tamper output	N.C.	N.C.	N.C.	N.C.
Day/night mode	—	—	—	—
International protection	IP55	IP55	IP55	IP55
Operating temperature	-30 to +60°C / -20 to +45°C	-30 to +60°C / -20 to +45°C	-30 to +60°C	-30 to +60°C
Environmental humidity	95% max.	95% max.	95% max.	95% max.
Dimensions (H x W x D mm)	201.5 x 91.7 x 86.3	201.5 x 91.7 x 86.3	200 x 81.5 x 81.2	200 x 81.5 x 81.2

	VXS-RAM	VXS-RDAM	VXI-ST	VXI-AM
				
	P23	P23	P24	P24
Detection method	PIR	PIR & MW	PIR	PIR
Anti-Masking Coverage	✓	✓	—	✓
Coverage	12m 90° wide	12m 90° wide	12m 90° wide	12m 90° wide
Detection zones	Horizontal 8pairs, vertical 2 layers	Horizontal 8pairs, vertical 2 layers	Horizontal 8 pairs, vertical 2 layers	Horizontal 8 pairs, vertical 2 layers
Mounting height	0.8 - 1.2m	0.8 - 1.2m	0.8 - 1.2m	0.8 - 1.2m
Double-layered detection patterns	✓	✓	✓	✓
Intelligent AND detection logic	✓	✓	✓	✓
Pet immunity	✓	✓	✓	✓
SMDA logic	✓	✓	✓	✓
Immunity switch	—	—	—	—
Area masking method	Seal	Seal	Seal	Seal
Double conductive shielding	✓	✓	✓	✓
Sensitivity adjustment	H / M / L	H / M / L	H / M / L	H / M / L
Advanced temperature compensation logic	✓	✓	✓	✓
Pulse Count	2	2	2	2
Power supply	3 to 9 V DC Lithium or Alkaline Battery	3 to 9 V DC Lithium or Alkaline Battery	9.5 - 18 VDC	9.5 - 18 VDC
Current consumption	10 µA standby / 4 mA max. at 3 V DC	18 µA standby / 8 mA max. at 3 V DC	20mA (max.)	20mA (max.)
Alarm output	N.C. / N.O. Selectable-Solid State Switch 10 V DC 0.01 A max.	N.C. / N.O. Selectable-Solid State Switch 10 V DC 0.01 A max.	Selectable N.C./N.O. 28 VDC 0.1A (max)	Selectable N.C./N.O. 28 VDC 0.1A (max)
Alarm indication LED	✓	✓	✓	✓
Tamper output	N.C.	N.C.	N.C.	N.C.
Day/night mode	—	—	—	—
International protection	IP55	IP55	IP55	IP55
Operating temperature	-20 to +60°C	-20 to +45°C	-30 to +60°C	-30 to +60°C
Environmental humidity	95% max.	95% max.	95% max.	95% max.
Dimensions (H x W x D mm)	199.3 x 81.6 x 109.3	199.3 x 81.6 x 109.3	181.9 x 70.9 x 64.5	181.9 x 70.9 x 64.5

WXI-R	WXI-RAM	VXS-AM	VXS-DAM
			
P21	P21	P22	P22
PIR	PIR	PIR	PIR & MW
—	✓	✓	✓
180° wide	180° wide	12m 90° wide	12m 90° wide
Horizontal 14 pairs, vertical 2 layers	Horizontal 14 pairs, vertical 2 layers	Horizontal 8pairs, vertical 2 layers	Horizontal 8pairs, vertical 2 layers
0.8 - 1.2m	0.8 - 1.2m	0.8 - 1.2m	0.8 - 1.2m
✓	✓	✓	✓
✓	✓	✓	✓
✓	✓	✓	✓
✓	✓	✓	✓
—	—	—	—
Shutter / Plate	Shutter / Plate	Seal	Seal
✓	✓	✓	✓
H / M / L	H / M / L	H / M / L	H / M / L
✓	✓	✓	✓
1 / 2	1 / 2	2	2
3 to 3.6 V DC lithium batteries	3 to 3.6 V DC lithium batteries	9.5 - 18 VDC	9.5 - 18 VDC
15 µA stand-by 4 mA max. at 3 V DC except walk test	16 µA stand-by 4 max. at 3 V DC except walk test	24 mA max. at 12 VDC	35 mA max. at 12 VDC
Solidstate switch, 10 V DC 0.01 A max. [Individual;Right/Left or General], [N.O. or N.C.] are selectable	Solidstate switch, 10 V DC 0.01 A max. [Individual;Right/Left or General], [N.O. or N.C.] are selectable	N.C. / N.O. Selectable 28 VDC 0.1 A max.	N.C. / N.O. Selectable 28 VDC 0.1 A max.
✓	✓	✓	✓
N.C.	N.C.	N.C.	N.C.
—	—	—	—
IP55	IP55	IP55	IP55
-30 to +60°C	-30 to +60°C	-20 to +60°C	-20 to +45°C
95% max.	95% max.	95% max.	95% max.
200 x 81.5 x 119.2	200 x 81.5 x 119.2	199.3 x 81.6 x 70.3	199.3 x 81.6 x 70.3

VXI-DAM	VXI-R	VXI-RAM	VXI-RDAM
			
P24	P25	P25	P25
PIR & MW	PIR	PIR	PIR & MW
✓	—	✓	✓
12m 90° wide	12m 90° wide	12m 90° wide	12m 90° wide
Horizontal 8 pairs, vertical 2 layers	Horizontal 8 pairs, vertical 2 layers	Horizontal 8 pairs, vertical 2 layers	Horizontal 8 pairs, vertical 2 layers
0.8 - 1.2m	0.8 - 1.2m	0.8 - 1.2m	0.8 - 1.2m
✓	✓	✓	✓
✓	✓	✓	✓
✓	✓	✓	✓
✓	✓	✓	✓
STD/Immunity (microwave)	—	—	STD/Immunity (microwave)
Seal	Seal	Seal	Seal
✓	✓	✓	✓
H / M / L	H / M / L	H / M / L	H / M / L
✓	✓	✓	✓
2	2	2	2
9.5 - 18 VDC	3 - 9 VDC (Lithium or Alkaline battery)	3 - 9 VDC (Lithium or Alkaline battery)	3 - 9 VDC (Lithium or Alkaline battery)
20mA (max.)	9µA (at stand-by) 4mA (max.)	9µA (at stand-by) 4mA (max.)	18µA (at stand-by) 8mA (max.)
Selectable N.C./N.O. 28 VDC 0.1A (max)	Selectable-Solid N.C./N.O. State Switch 10 VDC 0.01A (max)	Selectable-Solid N.C./N.O. State Switch 10 VDC 0.01A (max)	Selectable-Solid N.C./N.O. State Switch 10 VDC 0.01A (max)
✓	✓	✓	✓
N.C.	N.C.	N.C.	N.C.
—	—	—	—
IP55	IP55	IP55	IP55
-30 to +60°C	-20 to +60°C	-20 to +60°C	-20 to +60°C
95% max.	95% max.	95% max.	95% max.
181.9 x 70.9 x 64.5	185.9 x 71.3 x 105.5	185.9 x 71.3 x 105.5	185.9 x 71.3 x 105.5

OUTDOOR PROTECTION

INDOOR PROTECTION

RED WALL

ACCESS CONTROL

TECHNICAL INFORMATION

PRODUCT SPECIFICATIONS





OUTDOOR PROTECTION





INDOOR PROTECTION

REDWALL







ACCESS CONTROL





TECHNICAL INFORMATION

	BXS-ST	BXS-AM	BXS-R	BXS-RAM
				
	P26	P26	P27	P27
Detection method	PIR	PIR	PIR	PIR
Anti-Masking	—	✓	—	✓
Coverage	24m ; 12m 180° narrow	24m ; 12m 180° narrow	24m ; 12m 180° narrow	24m ; 12m 180° narrow
Detection zones	4 zones ; 2 zones on each side	4 zones ; 2 zones on each side	4 zones ; 2 zones on each side	4 zones ; 2 zones on each side
Mounting height	0.8 - 1.2m	0.8 - 1.2m	0.8 - 1.2m	0.8 - 1.2m
Double-layerd detection patterns	✓	✓	✓	✓
Intelligent AND detection logic	✓	✓	✓	✓
Pet immunity	✓	✓	✓	✓
SMDA logic	✓	✓	✓	✓
Immunity switch	—	—	—	—
Area masking method	—	—	—	—
Double conductive shielding	✓	✓	✓	✓
Sensitivity adjustment	H / M / L	H / M / L	H / M / L	H / M / L
Advanced temperature compensation logic	✓	✓	✓	✓
Pulse Count	1 / 2	1 / 2	1 / 2	1 / 2
Power supply	9.5 - 18VDC	9.5 - 18VDC	3 to 9V DC Lithium or Alkaline batteries	3 to 9V DC Lithium or Alkaline batteries
Current consumption	31mA (max.)	31mA (max.)	15 µA stand-by / 8 mA max. at 3V DC	15 µA stand-by / 8 mA max. at 3V DC
Alarm output	28V DC 0.1 A max. [Individual;Right or General], [N.O. or N.C.] are selectable	28V DC 0.1 A max. [Individual;Right or General], [N.O. or N.C.] are selectable	Solidstate switch, 10V DC 0.01 A max. [Individual;Right or General], [N.O. or N.C.] are selectable	Solidstate switch, 10V DC 0.01 A max. [Individual;Right or General], [N.O. or N.C.] are selectable
Alarm indication LED	✓	✓	✓	✓
Tamper output	N.C. 28V DC 0.1 A max. open when face cover, main unit or base unit is removed	N.C. 28V DC 0.1 A max. open when face cover, main unit or base unit is removed	Tamper output is shared with trouble output.	Tamper output is shared with trouble output.
Day/night mode	—	—	—	—
International protection	IP55	IP55	IP55	IP55
Operating temperature	-30 to +60°C	-30 to +60°C	-30 to +60°C	-30 to +60°C
Environmental humidity	95% max.	95% max.	95% max.	95% max.
Dimensions (H x W x D mm)	199.7 x 92.8 x 52.7	199.7 x 92.8 x 52.7	199.7 x 92.8 x 98.7	199.7 x 92.8 x 98.7

	HX-80NRAM	HX-40	HX-40AM	HX-40DAM
				
	P33	P34	P34	P34
Detection method	PIR	PIR	PIR	PIR
Anti-Masking	✓	—	✓	✓
Coverage	24 x 2m narrow	12m 85° wide	12m 85° wide	12m 85° wide
Detection zones	20	94	94	94
Mounting height	2.5 - 3.0m	2.5 - 3.0m	2.5 - 3.0m	2.5 - 3.0m
Double-layerd detection patterns	—	—	—	—
Intelligent AND detection logic	✓	✓	✓	✓
Pet immunity	✓	✓	✓	✓
SMDA logic	—	—	—	—
Immunity switch	STD/Immunity	STD/Immunity	STD/Immunity	STD/Immunity
Area masking method	Plate and Flap	Seal	Seal	Seal
Double conductive shielding	✓	✓	✓	✓
Sensitivity adjustment	H / M / L	H / M / L	H / M / L	H / M / L
Advanced temperature compensation logic	✓	✓	✓	✓
Pulse Count	2	2	2	2
Power supply	3-7 VDC (Lithium battery)	9.5 - 18VDC	9.5 - 18VDC	9.5 - 18VDC (Lithium battery)
Current consumption	30µA (at stand-by) 4mA (max.)	35mA max.	40mA max.	50mA max. at 12VDC
Alarm output	Selectable-Solid N.C./N.O. State Switch 10VDC 0.01A (max)	Form C 28VDC 0.2A max.	Form C 28VDC 0.2A max.	Form C 28VDC 0.2A max.
Alarm indication LED	✓	✓	✓	✓
Tamper output	Form C	N.C.	N.C.	N.C.
Day/night mode	—	—	—	—
International protection	IP55	IP55	IP55	IP55
Operating temperature	-20 to +60°C	-20 to +60°C	-20 to +60°C	-20 to +60°C
Environmental humidity	95% max.	95% max.	95% max.	95% max.
Dimensions (H x W x D mm)	197.5 x 93 x 286	205 x 99 x 266	205 x 99 x 266	205 x 99 x 266

PRODUCT SPECIFICATIONS

BX-80N	BX-80NR	FTN-ST/AM	FTN-R/RAM/R-PT/RAM-PT	HX-80N	HX-80NAM
					
P28	P29	P30	P31	P32	P32
PIR	PIR	PIR	PIR	PIR	PIR
—	—	FTN-AM : ✓	FTN-RAM : ✓ FTN-RAM-PT : ✓	—	✓
24m Narrow (12m on each side)	24m Narrow (12m on each side)	5 x 1m	5 x 1m	24 x 2m narrow	24 x 2m narrow
4 zones (2 on each side)	4 zones (2 on each side)	2	2	20	20
0.8 - 1.2m	0.8 - 1.2m	0.8 - 1.2m	0.8 - 1.2m	2.5 - 3.0m	2.5 - 3.0m
✓	✓	—	—	—	—
—	—	✓	✓	✓	✓
✓	✓	✓	✓	✓	✓
—	—	✓	✓	—	—
—	—	—	—	STD/Immunity Plate and Flap	STD/Immunity Plate and Flap
✓	✓	✓	✓	✓	✓
H / M / L	H / M / L	STD/LOW	STD/LOW	H / M / L	H / M / L
✓	✓	✓	✓	✓	✓
2	2	2	2	2	2
10 - 28 VDC	3 - 9 VDC (Lithium or Alkaline battery)	9.5 - 18 VDC	3 - 9 VDC	3 - 9 VDC	3 - 9 VDC
38mA max.	3mA max. (walktest, LED on) 15µA (standby)	FTN-ST : 17 mA max. FTN-AM : 20mA max.	10µA (at stand-by) 3mA (max.)	35mA max.	35mA max.
2 Outs : N.O./ N.C. 28 VDC 0.2A max.	Form C solid state switch 10 VDC 0.01A max.	Selectable N.C./N.O. 28 VDC 0.1A (max)	Selectable-Solid N.C./N.O. State Switch 10 VDC 0.01A (max)	Selectable-Solid N.C./N.O. State Switch 10 VDC 0.01A (max)	Selectable-Solid N.C./N.O. State Switch 10 VDC 0.01A (max)
✓	✓	✓	✓	✓	✓
N.C.	Form C	N.C.	N.C.	N.C.	N.C.
—	—	—	—	—	—
IP55	IP55	IP55	IP55	IP55	IP55
-20 to +50°C	-20 to +50°C	-20 to +60°C	-20 to +60°C	-20 to +60°C	-20 to +60°C
95% max.	95% max.	95% max.	95% max.	95% max.	95% max.
232.7 x 55 x 68.7	235 x 56 x 128	155 x 35 x 42.5	155 x 70 x 425.5	197.5 x 93 x 286	197.5 x 93 x 286

HX-40RAM	QXI-ST/DT	QXI-R/RDT	LX-402	LX-802N
				
P35	P36	P37	P38	P38
PIR	QXI-ST : PIR QXI- DT : PIR & MW	QXI-R : PIR QXI- RDT : PIR & MW	PIR	PIR
✓	—	—	—	—
12m 85° wide	12m 120° wide	12m 120° wide	12 x 15m	24 x 2m
94	Multi level: 40 zones Pet alley: 18 zones	Multi level: 40 zones Pet alley: 18 zones	Multi-Level : 40 Pet Alley : 18	Multi-Level : 12 Pet Alley : 4
2.5 - 3.0m	2.2 - 2.7m	2.2 - 2.7m	Multi-Level:2.5m max Pet Alley : 1.2-1.5m	Multi-Level:2.5m max Pet Alley : 1.2-1.5m
—	—	—	—	—
✓	✓	✓	—	—
✓	✓	✓	Pet alley	Pet alley
—	—	—	—	—
STD/Immunity Seal	STD/Immunity Seal	STD/Immunity Seal	Seal	—
✓	✓	✓	✓	✓
H / M / L	H / M / L	H / M / L	H / M / L	H / M / L
✓	✓	✓	—	—
2	2	2	TEST (1) / 2	TEST (1) / 2
3 - 7.2 VDC	9.5 - 16VDC	CR123A (3 V DC)	10.8 - 13.2 VDC	10.8 - 13.2 VDC
Lithium batteries 4mA (max.) 30µA (stand by)	20 mA max. at 12 VDC 30 mA max. at 12 VDC	9µA stand-by 11 mA max. at 3VDC 16µA stand-by 11 mA max. at 3VDC	25mA max.	25mA max.
Form C solid state switch 10 VDC 0.01A max.	Form C 28 VDC 0.1A max.	Form C 3 VDC 0.01A max.	Form C 28 VDC 0.2A max.	Form C 28 VDC 0.2A max.
✓	✓	✓	✓	✓
Form C	N.C.	N.C.	N.C.	N.C.
—	—	—	✓	✓
IP55	IP54	IP54	IP54	IP54
-20 to +60°C	-40 to +60°C / -40 to +45°C	-40 to +60°C / -40 to +45°C	-20 to +50°C	-20 to +50°C
95% max.	95% max.	95% max.	95% max.	95% max.
205 x 99 x 266	144.5 x 78 x 59	144.5 x 78 x 83.5	141 x 74.8 x 53.5	141 x 74.8 x 57.5

OUTDOOR PROTECTION

INDOOR PROTECTION

RED WALL

ACCESS CONTROL

TECHNICAL INFORMATION

FLX-A-AM/DAM

C-ZONE

INDOOR PIR / COMBINATION DETECTOR



FlipX is the indoor motion detector not only with a lot of highly evaluated features for existing indoor motion detectors but also with know-how obtained from our experiences of outdoor motion detector development.

Advanced model

- 15 m (50 ft.) 85 degree Wide
- 24 m (80 ft.) Narrow
- Anti-Masking

FEATURES

- Flip Lens
- Easily Viewable LED Color
- Human-Catch Element
- Refined Spherical Lens
- 180 Degree Cover Lock
- SMDA Logic
- Removable Terminal Block
- Double Protection Anti-Masking
- Down Zone Switch
- EOL Resistor Socket
- Super High Sensitivity

COVERAGES

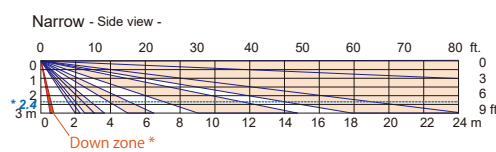
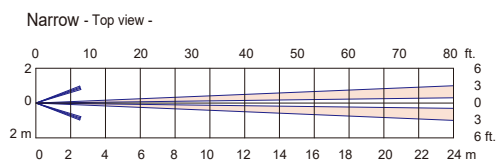
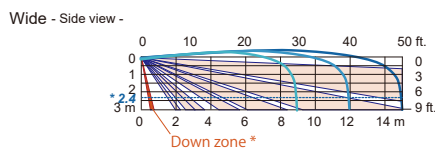
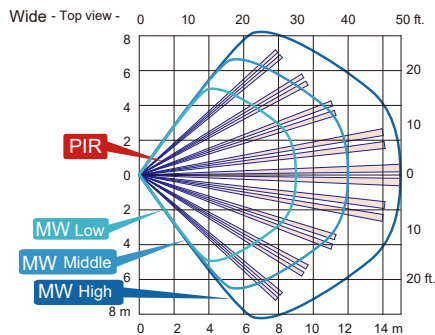

- NOTE**
- The * 2.4 dotted line indicates the recommended mounting height.
 - When "Narrow" is selected in the lens setting, MW detection will be stopped.
 - Down zone* can be deleted by switch setting.
 - Narrow area setting of FLX-A-DAM is not certified to NF&A2P.

OPTIONS

- CW-G3 : Wall Tamper / Wall or Ceiling mount selectable

DIMENSIONS

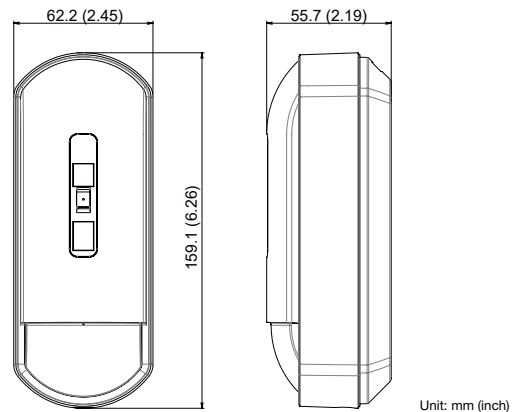

SPECIFICATIONS

Part name	FLX-A-AM	FLX-A-DAM
Mounting height	2.0 to 3.0 m (6'7" to 9'8")	
Coverage	Wide : 15 m (50 ft.) 85° Narrow : 24 m (80 ft.) 5° (No MW detection at "Narrow" setting)	
Alarm period	2.0 ± 0.5 s	
Warm-up period	Approx. 60 s (LED blinks)	
LED indicator	Multiple: Warm-up / Green:Alarm and Masking detection Yellow: Self test error / Red:Low voltage	
Power input	9.5 to 16 V DC	
Current draw	12 mA (normal) 16 mA (max.) at 12 V DC	16 mA (normal) 21 mA (max.) at 12 V DC
Relay output	Trouble	N.C. 24 V DC 0.1 A max. (Resistive load)
	Alarm	N.C. 24 V DC 0.1 A max. (Resistive load)
	Tamper	N.C. 24 V DC 0.1 A max. (Resistive load) (Open when the cover is removed)
Remote LED	✓	
Operation temperature	-20°C to +50°C (-4°F to +122°F) -20°C to +45°C (-4°F to +113°F)	
Temperature compensation	Digital (SMDA)	
Relative humidity	95% RH max.	
Dimension	H: 159.1 mm x W: 62.2 mm x D: 55.7 mm (H: 5.09" x W: 2.42" x D: 2.00")	
Weight	180 g (6.35 oz)	200 g (7.05 oz)

- Specifications and designs are subject to change without prior notice.
- These units are designed to detect an intruder and activate an alarm control panel. Being only a part of a complete system, we cannot accept responsibility for any damages or other consequences resulting from an intrusion.
- Advanced models (FLX-A-AM and FLX-A-DAM) are certified to NF&A2P when operation temperatures are -10°C to +55°C (14°F to +131°F).

OUTDOOR PROTECTION

INDOOR PROTECTION

REDWALL

ACCESS CONTROL

TECHNICAL INFORMATION

FLX-P-ST/DT

C-ZONE

INDOOR PIR / COMBINATION DETECTOR



FlipX is the indoor motion detector not only with a lot of highly evaluated features for existing indoor motion detectors but also with know-how obtained from our experiences of outdoor motion detector development.

- Professional Model
- 15 m (50 ft.) 85 degree Wide
 - 24m (80 ft.) Narrow

FEATURES

- Flip Lens
- Easily Viewable LED Color
- Human-Catch Element
- Refined Spherical Lens
- 180 Degree Cover Lock
- SMDA Logic
- PEU Socket

COVERAGES

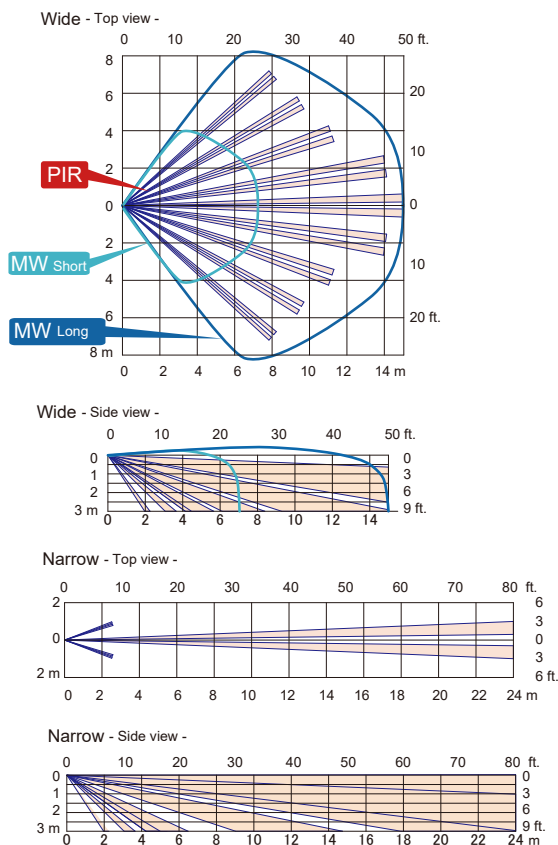

NOTE

- When "Narrow" is selected at the jumper pin, MW detection will be stopped.
- Narrow area settings are not certified to the following standards. EN 50131-2-2 (FLX-P-ST)/EN 50131-2-4 (FLX-P-DT), INCERT and SBSC.

OPTIONS

- CW-G2: Wall or Ceiling mount selectable

DIMENSIONS

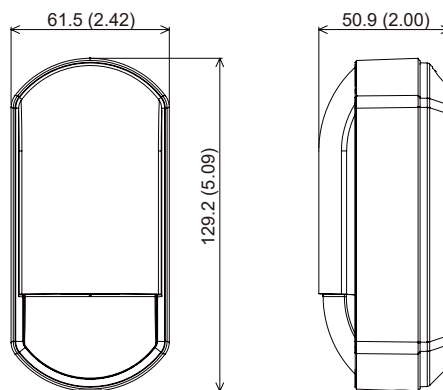

Unit: mm (inch)

SPECIFICATIONS

Part name	FLX-P-ST	FLX-P-DT
Mounting height	2.0 to 3.0 m (6'7" to 9'8")	
Coverage	Wide : 15 m (50') 85° Narrow : 24 m (80') 5° (MW will be stopped in "Narrow" setting)	
Alarm period	2.0 ± 0.5 s	
Warm-up period	Approx. 60 s (LED blinks)	
LED indicator	Green: [1] Warm-up [2] Alarm	
Power input	9.5 to 16 V DC	
Current draw	8 mA (normal) 11 mA (max.) at 12 V DC	11 mA (normal) 14 mA (max.) at 12 V DC
Relay output	Trouble	—
	Alarm	N.C. 24 V DC 0.1 A max. (Resistive load)
	Tamper	N.C. 24 V DC 0.1 A max. (Resistive load) (Open when the cover is removed)
Remote LED	✓	
Operation temperature	-20°C to +50°C (-4°F to +122°F)	-20°C to +45°C (-4°F to +113°F)
Temperature compensation	Digital (SMDA)	
Relative humidity	95% RH max.	
Dimension	H: 129.2 x W: 61.5 x D: 50.9 mm (H: 5.09" x W: 2.42" x D: 2.00")	
Weight	95 g (3.35 oz)	110 g (3.88 oz)

• Specifications and designs are subject to change without prior notice.
• These units are designed to detect an intruder and activate an alarm control panel. Being only a part of a complete system, we cannot accept responsibility for any damages or other consequences resulting from an intrusion.

FLX-S-ST/DT

C-ZONE

INDOOR PIR / COMBINATION DETECTOR

OUTDOOR PROTECTION

INDOOR PROTECTION

REDWALL

ACCESS CONTROL

TECHNICAL INFORMATION



FlipX is the indoor motion detector not only with a lot of highly evaluated features for existing indoor motion detectors but also with know-how obtained from our experiences of outdoor motion detector development.

- Standard Model
- 12 m (40 ft.) 85 degree Wide
 - 18 m (60 ft.) Narrow

FEATURES

- Flip Lens
- Easily Viewable LED Color
- Human-Catch Element
- Refined Spherical Lens
- 180 Degree Cover Lock
- SMDA Logic
- Pet Tolerance

COVERAGES

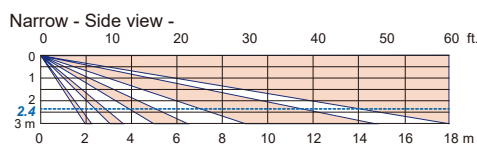
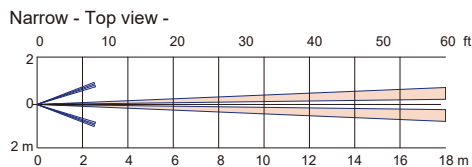
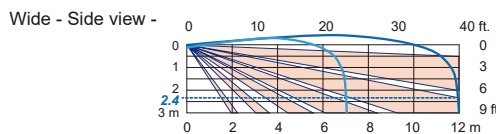
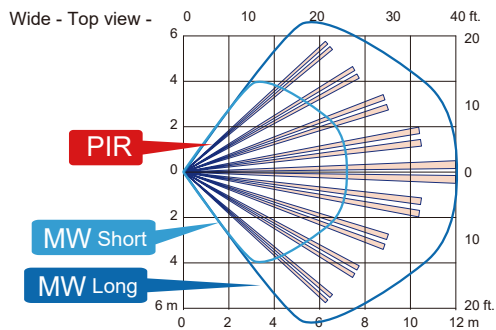

- NOTE**
- The dotted line indicates the recommended mounting height.
 - When "Narrow" is selected at the jumper pin, MW be stopped.
 - Narrow area settings are not certified to the following standards.
EN 50131-2-2:2017(FLX-S-ST)/EN 50131-2-4:2020, INCERT and SBSC.

DIMENSIONS

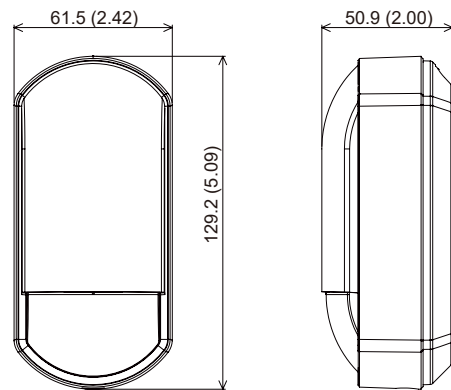

Unit: mm (inch)

SPECIFICATIONS

Part name	FLX-S-ST	FLX-S-DT
Mounting height	2.0 to 3.0 m (6'7" to 9'8")	
Coverage	Wide : 12 m (40') 85°	
	Narrow : 18 m (60') 5° (MW will be stopped in "Narrow" setting)	
Alarm period	2.0 ± 0.5 s	
Warm-up period	Approx. 60 s (LED blinks)	
LED indicator	Green: [1] Warm-up [2] Alarm	
Power input	9.5 to 16 V DC	
Current draw	8 mA (normal)	11 mA (normal)
	11 mA (max.) at 12 V DC	14 mA (max.) at 12 V DC
Relay output	Trouble	—
	Alarm	N.C. 24 V DC 0.1 A max. (Resistive load)
	Tamper	N.C. 24 V DC 0.1 A max. (Resistive load) (Open when the cover is removed)
Remote LED	—	✓
Operation temperature	-20°C to +50°C (-4°F to +122°F)	-20°C to +45°C (-4°F to +113°F)
Temperature compensation	Digital (SMDA)	
Relative humidity	95% RH max.	
Dimension	H: 129.2 x W: 61.5 x D: 50.9 mm (H: 5.09" x W: 2.42" x D: 2.00")	
Weight	90 g (3.17 oz)	105 g (3.7 oz)

- Specifications and designs are subject to change without prior notice.
- These units are designed to detect an intruder and activate an alarm control panel. Being only a part of a complete system, we cannot accept responsibility for any damages or other consequences resulting from an intrusion.

OPTIONS

- CW-G2: Wall or Ceiling mount selectable

CX-702/702MKII

C-ZONE

LONG RANGE PIR DETECTOR



The CX-702 series is designed to give extremely stable long-range detection performance in a variety of internal commercial and industrial applications.

- CX-702 – standard model
- CX-702MKII – double detection zones model

FEATURES

- Multi-focus technology
- Double conductive shielding
- Temperature compensation
- Sealed optics
- Spherical lens design
- Dual purpose optics: wide-angle or long-range
- 3-step lens angle adjustment

COVERAGES

TOP VIEW CX-702

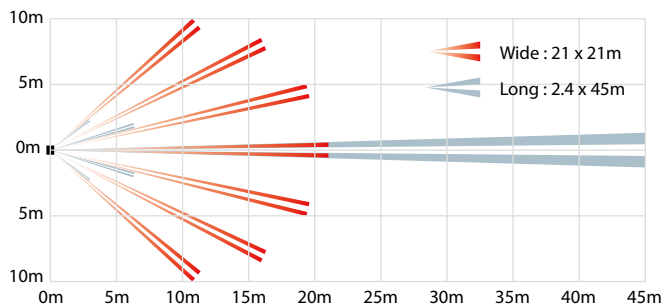

SIDE VIEW CX-702

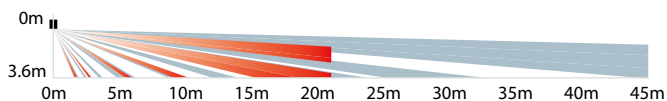

TOP VIEW CX-702MKII

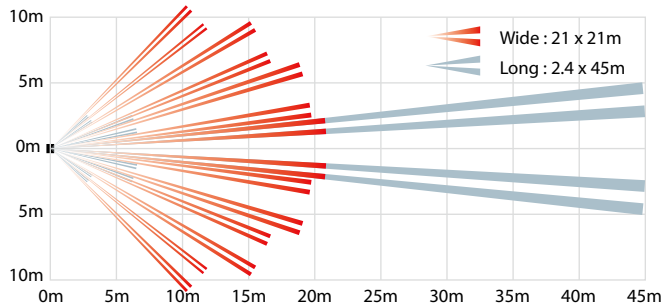

SIDE VIEW CX-702MKII

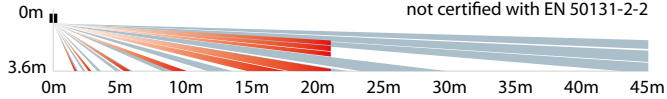

OPTIONS

- CA-1W : Multi-angle wall mounting bracket
- CA-2C : Multi-angle ceiling mounting bracket

DIMENSIONS

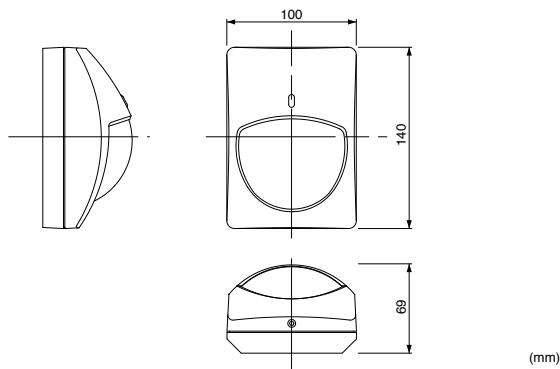

SPECIFICATIONS

Model	CX-702	CX-702MKII
PIR coverage	Wide : 21m x 21m 85° 68 zones Long : 2.4m x 45m 22 zones	
Detection zones	Wide : 68 zones, Long : 22 zones Wide : 136 zones, Long : 44 zones	
Sensitivity	1.6°C at 0.6m/sec. at 2.4m mounting height	
Detectable speed	0.3 to 1.5m/sec.	
Power supply	9.5 to 16 VDC	
Current consumption	11mA (max.) at 12 VDC	
Alarm period	Approx. 2.5 sec.	
Alarm output	N.C. 28 VDC 0.2A max.	
Alarm interval	—	
Tamper switch	N.C. opens when cover is removed. 28 VDC 0.1A max.	
Pulse count	Approx. 20 sec. 2 or 4	
Warm-up period	Approx. 60 sec.	
LED indicator	Alarm condition	
Operating temperature	-20 to +50°C	
Environmental humidity	95% max.	
RF interference	No Alarm 30V/m	
Mounting height	1.5 to 3.6 m	
Weight	200 g	
Dimensions (H x W x D)	140 mm x 100 mm x 69 mm	

Specifications and design are subject to change without prior notice.

OUTDOOR PROTECTION

INDOOR PROTECTION

REDWALL

ACCESS CONTROL

TECHNICAL INFORMATION

CX-702RS

C-ZONE

BATTERY OPERATED LONG RANGE PIR DETECTOR

The CX-702 series is designed to give extremely stable long-range detection performance in a variety of internal commercial and industrial applications.

- CX-702RS – low current battery operated model



COVERAGES

TOP VIEW

Wide : 21 x 21m Long : 2.4 x 45m

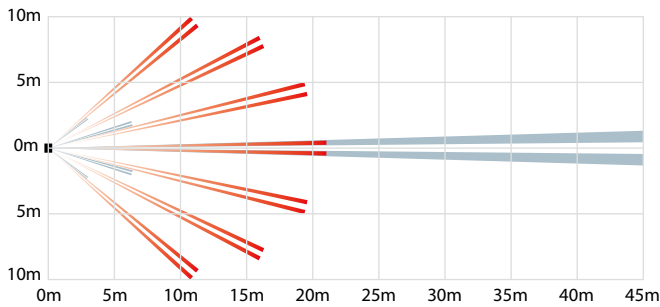

SIDE VIEW

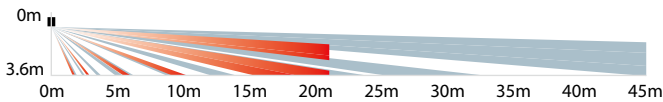

OPTIONS

- CA-1W : Multi-angle wall mounting bracket
- CA-2C : Multi-angle ceiling mounting bracket
- BA-70 : Back box for wireless transmitter

FEATURES

- Multi-focus technology
- Double conductive shielding
- Temperature compensation
- Sealed optics
- Spherical lens design
- Dual purpose optics: wide-angle or long-range
- 3-step lens angle adjustment

DIMENSIONS

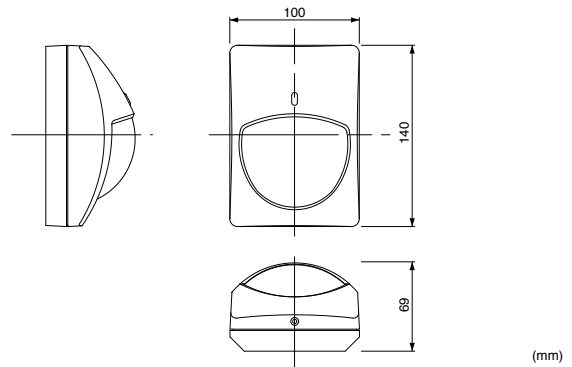

SPECIFICATIONS

Model	CX-702RS
PIR coverage	Wide : 21m x 21m 85° 68 zones Long : 2.4m x 45m 22 zones
Detection zones	Wide : 68 zones, Long : 22 zones
Sensitivity	1.6°C at 0.6m/sec. at 2.4m mounting height
Detectable speed	0.3 to 1.5m/sec.
Power supply	3 to 9 VDC alkaline battery or lithium battery
Current consumption	5µA (standby) 10mA (walktest, LED on)
Alarm period	Approx. 2.5 sec.
Alarm output	Form C 10 VDC 0.01A max.
Alarm interval	Succeeding signals are not output even though detection occurs within 2 min. after the first alarm.
Tamper switch	Form C 28 VDC 0.1A max.
Pulse count	Approx. 20 sec. 2 or 4
Warm-up period	Approx. 90 sec.
LED indicator	Alarm condition
Operating temperature	-10 to +50°C
Environmental humidity	95% max.
RF interference	No Alarm 20V/m
Mounting height	1.5 to 3.6 m
Weight	200 g
Dimensions (H x W x D)	140 mm x 100 mm x 69 mm

Specifications and design are subject to change without prior notice.
Batteries and wireless transmitters are not included in these products.

SX-360Z

C-ZONE

360° CEILING-MOUNT PIR DETECTOR WITH 276 HIGH DENSITY DETECTION ZONES



The SX-360 series ceiling-mount detector, with its unique zoom function and highly dense, triple-element detection pattern, provides unsurpassed detection performance at any ceiling height up to 5 meters.

- SX-360Z – standard model with double conductive shielding

FEATURES

- Double conductive shielding
- Multi-focus optics
- Highly dense coverage (276 zones)
- Zoom function/ pattern adjustment
- Temperature protection
- Noise reduction circuit
- LED remote control terminal

N.B. For ceiling mounting only

COVERAGE

TOP VIEW

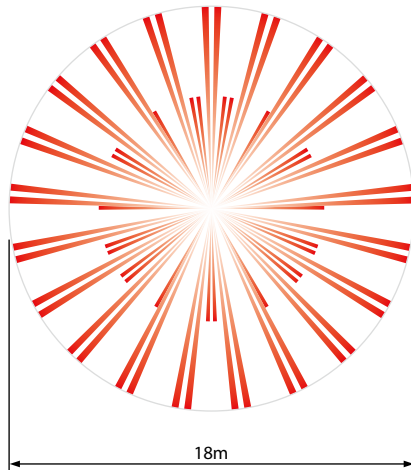

SIDE VIEW

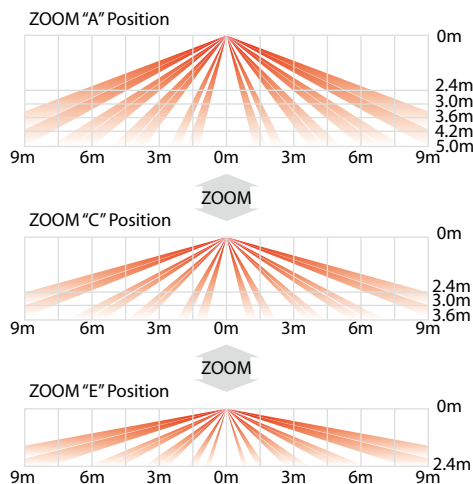

DIMENSIONS

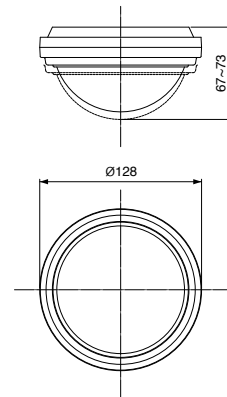

(mm)

SPECIFICATIONS

Model	SX-360Z
PIR coverage	ø18m 360° zoom
Detection zones	276 zones
Sensitivity	1.6°C at 0.6m/sec. at 2.4m mounting height
Detectable speed	0.3 to 1.8m/sec.
Power supply	6 to 18 VDC
Current consumption	18mA (max.)
Alarm period	2.0 ± 0.5 sec.
Alarm output	N.C. 28 VDC 0.2A max.
Tamper switch	N.C. opens when cover is removed: 30 VDC 0.1A max.
Pulse count	20 ± 5 sec. 1, 2 or 4
Warm-up period	Approx. 20 sec. (LED blinks)
LED indicator	LED blinks during warm-up period
	Alarm condition
Operating temperature	-20 to +50°C
Environmental humidity	95% max.
RF interference	No Alarm 30V/m
Mounting height	2.4 to 5.0m
Weight	224 g
Dimensions (H x W x D)	ø128mm x 67 - 73mm

Specifications and design are subject to change without prior notice.

OUTDOOR PROTECTION

INDOOR PROTECTION

REDWALL

ACCESS CONTROL

TECHNICAL INFORMATION

FX-360

C-ZONE

360° CEILING-MOUNT PIR DETECTOR

OUTDOOR PROTECTION

INDOOR PROTECTION

RED WALL

ACCESS CONTROL

TECHNICAL INFORMATION



The FX-360 ceiling-mount detector with its unique, highly durable spherical lens offers unparalleled 360° detection performance.

FEATURES

- Spherical Lens design
- RFI protection
- Temperature protection
- Noise reduction circuit
- Selectable pulse count (2 or 4)
- LED remote control terminal

N.B. For ceiling mounting only

COVERAGE

TOP VIEW

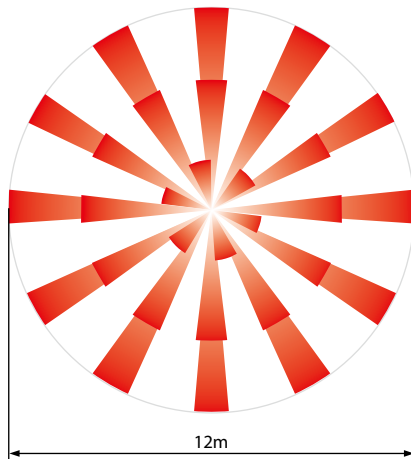

SIDE VIEW

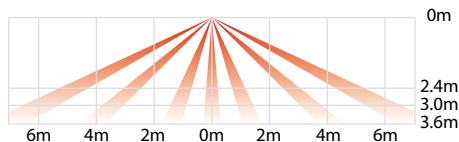

DIMENSIONS

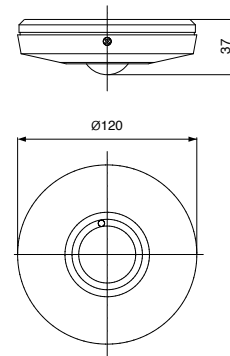

(mm)

SPECIFICATIONS

Model	FX-360
Detection method	Passive Infrared
Detection zones	62 zones
Mounting location	Ceiling
Coverage / Mounting height	ø8 to ø12 m at 2.4 to 3.6 m
LED indicator	LED is blinking during warm-up period. Alarm indicator optional
Alarm period	2.0 ±0.5 sec.
Alarm output	N.C., 28 VDC 0.2 A (max.)
Tamper switch	N.C., Opens when cover removed.
Tamper output	30 V DC 0.1 A (max.)
Pulse Count	2.0 ±5 sec. 2 or 4
Warm up period	Approx. 30 sec. (LED blinks.)
Power input	9.5 to 18 VDC
Current draw	17 mA/(normal), 18 mA/(max.)
Weight	140 g (4.9 oz)
Operating temperature	-20°C to +50°C (-4°F to +122°F)
Environment humidity	95% (max.)
RF interference	No Alarm 20 V/m

Specifications and design are subject to change without prior notice.

AP-360B/360BR

C-ZONE

INDOOR RECESSED MOUNT PIR DETECTOR



Battery Operated Models are available at limited regions

The AP-360B is a series of recessed mount indoor PIR detectors. AP-360B provides a 360-degree volumetric detection area. The detector can offer low profile installation for various application scenes.

360-degree PIR

- AP-360B(C) Wired Model
- AP-360BR(C) Battery Operated Model

FEATURES

- Compact and Discreet design
- Detection Sensitivity : High, Medium, Low
- Tamper function
- Light Control Option (AP-360B only)
- Battery Saving Timer (Battery Operated Models only)

COVERAGES

[Ceiling Mount]

Top view

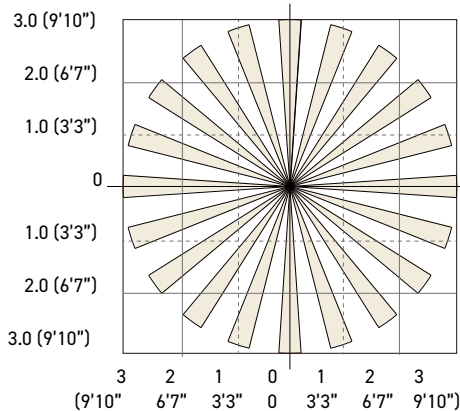

Side view

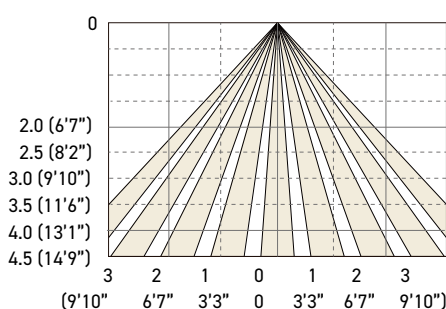

DIMENSIONS

Without switch
box mount

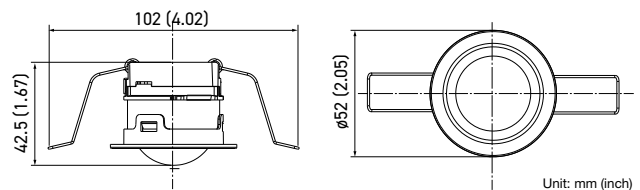

SPECIFICATIONS

Model	AP-360B(C)	AP-360BR(C)
Detection method	Passive infrared	
Detection area	ø6 m (ø20') at mounting height: 4.5 m (14'9" ft.)	
Mounting height	2.5 to 4.5 m (8'2" ft. to 14'9" ft.)	
Mounting type	Recessed ceiling mount/86-type box mount	
Sensitivity	2.0°C at 0.6 m/s (3.6°F at 2'/s)	
Detection speed	0.3 to 3.0 m/s (1'/s to 9'10"/s)	
LED indicator	Warm-up upon power on: blinking Stand-by: off Alarm: solid on	Warm-up upon power on: blinking Stand-by: off Walk test: solid on Alarm: off
Alarm cycle	2 s to 120 s (variable)	Approx. 2 s
Illuminance	20 to 320 lux (variable/not detected)	—
Battery saving timer	—	120 s / 5 s selectable
Alarm output	N.O./N.C., 28 V DC 200 mA max. N.C. 28 V DC 100 mA max.	N.O./N.C., 3.6 V DC 10 mA max.
Tamper switch	The contact opens once the casing is detached.	
Warm-up time	Approx. 60 s	
Power supply	9.5 to 16 V DC 12 V DC	2.7 to 3.6 V DC (CR123A battery) 3 V DC
Current	Stand-by: 11 mA, Max.: 13 mA	Stand-by: 10µA, Max.: 4 mA
PIR sensitivity	H/ M/ L	
Weight	50 g (1.76 oz)	
Operation temperature	-20 to +50°C (-4°F to +122°F)	
Operation humidity	< 95%	
Location	Indoors	
Dimensions	ø52 x 42.5 mm (ø2.05 in. x 1.67 in.): without switch box mount 86 x 86 x 42.5 mm (3.39 x 3.39 x 1.67 in.): with 86-type box mount	

• Specifications and designs are subject to change without prior notice.
• These units are designed to detect an intruder and activate an alarm control panel.
Being only a part of a complete system, we cannot accept responsibility for any damages or other consequences resulting from an intrusion.

OUTDOOR PROTECTION

INDOOR PROTECTION

REDWALL

ACCESS CONTROL

TECHNICAL INFORMATION

AP-20NB/20NBR

C-ZONE

INDOOR RECESSED MOUNT PIR DETECTOR

[Ceiling Mount]



[Wall Mount]

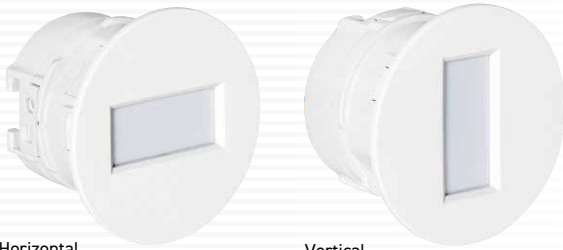

Horizontal

Vertical

Battery Operated Models are available at limited regions

The AP-20NB is a series of recessed mount indoor PIR detectors. AP-20NB provides a 20 ft. (6m) curtain area. The detector can offer low profile installation for various application scenes.

Curtain PIR

- AP-20NB(C) Wired Model
- AP-20NBR(C) Battery Operated Model

FEATURES

- Compact and Discreet design
- Detection Sensitivity : High, Medium, Low
- Tamper function
- Battery Saving Timer (Battery Operated Models only)

COVERAGES

[Ceiling Mount]

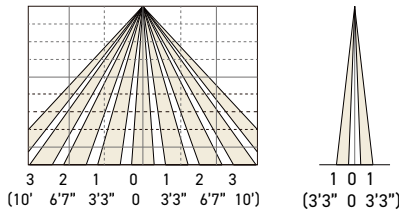

- Wall mount : Lower than 1.5 m (4.9 ft.) height (AP-20NB/20NBR only)
- Ceiling mount : 2.5 to 4.5 m (8.2 to 14.8 ft.) height

[Wall Mount]

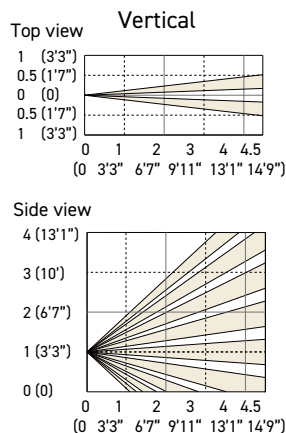
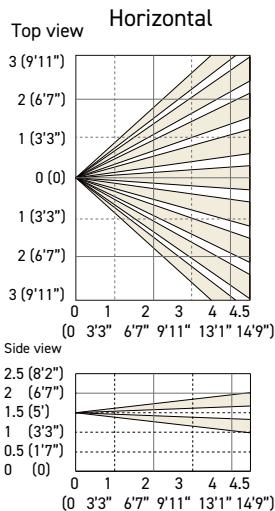

DIMENSIONS

Without switch box mount

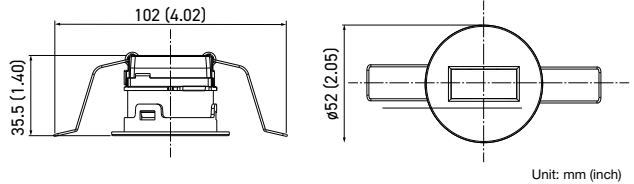

Unit: mm (inch)

SPECIFICATIONS

Model	AP-20NB(C)	AP-20NBR(C)
Detection method	Passive infrared	
Detection area	< Ceiling mount > 6.0 m x 1.0 m (20' x 3'3") at 4.5 m (14'9") height < Wall mount > 6.0 m x 4.5 m (20' x 14'9") at 1.5 m (4'11") height	
Mounting height	2.5 m to 4.5 m (8'2" to 14'9")	1.5 m (4'11"): Horizontal 1.0 m (3'3"): Vertical
Mounting type	Recessed ceiling mount/ Wall mount/ 86-type box mount	
Sensitivity	2.0°C at 0.6 m/s (3.6°F at 2'/s)	
Detection speed	0.3 to 3.0 m/s (1'/s to 9'10"/s)	
LED indicator	Warm-up upon power on: blinking Stand-by: off Alarm: solid on	Warm-up upon power on: blinking Stand-by: off Walk test: solid on Alarm: off
Alarm cycle	Approx. 2 s	
Illuminance	—	
Battery saving timer	—	120 s / 5 s selectable
Alarm output	N.O./N.C., 28 V DC 200 mA max. N.C. 28 V DC 100 mA max.	N.O./N.C., 3.6 V DC 10 mA max. 3 V DC
Tamper switch	The contact opens once the casing is detached.	
Warm-up time	Approx. 60 s	
Power supply	9.5 to 16 V DC 12 V DC	2.7 to 3.6 V DC (CR123A battery) 3 V DC
Current	Stand-by: 11 mA, Max.: 13 mA	Stand-by: 10 µA, Max.: 4 mA
PIR sensitivity	H/ M/ L	
Weight	50 g (1.76 oz)	
Operation temperature	-20 to +50°C (-4°F to +122°F)	
Operation humidity	< 95%	
Location	Indoors	
Dimensions	ø52 x 35.5 mm (ø2.05 in. x 1.40 in.): without switch box mount 86 x 86 x 36.5 mm (3.39 x 3.39 x 1.44 in.): with 86-type box mount	

• Specifications and designs are subject to change without prior notice.
• These units are designed to detect an intruder and activate an alarm control panel. Being only a part of a complete system, we cannot accept responsibility for any damages or other consequences resulting from an intrusion.

OPTIONS

CA-1W



Multi Angle Wall Mount Bracket for
• CX-702/702RS/702MKII

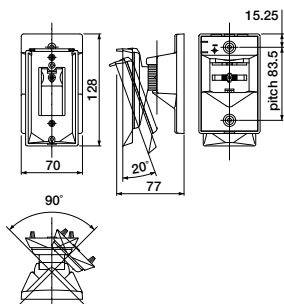

(mm)

CA-2C



Multi Angle Ceiling Mount Bracket for
• CX-702/702RS/702MKII

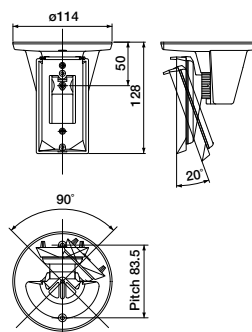

(mm)

BA-70



Transmitter Backbox for
• CX-702RS

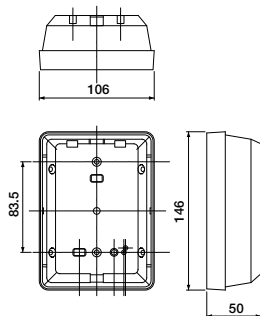

(mm)

CW-G2



Compliant to EN-Grade II Wall or Ceiling mount selectable
Horizontally +/-45°
Vertically -5 to 20° downward for
• FLX-P
• FLX-S

CW-G3



Compliant to EN-Grade III Wall Tamper as same as CW-G2 for
• FLX-A

PEU-B/C/D/E/F/G/H/I/J/K



Selectable plug-in end of line unit for
• CDX-DAM/AM/NAM
• FMX-ST/DST
• FMX-DT

Item	Trouble	Alarm	Tamper	Panels
PEU-B	6.8K	4.7K	4.7K	Old GE/Aritech
PEU-C	12.0K	1.0K	1.0K	Honeywell Galaxy (U.K.)
PEU-D	3.0K	1.0K	1.0K	Honeywell Galaxy (Benelux)
PEU-E	15.0K	1.1K	1.1K	Satel
PEU-F	5.6K	5.6K	5.6K	DSC, Ksenia
PEU-G	8.2K	8.2K	8.2K	Guardall
PEU-H	2.2K	4.7K	2.2K	Old Texecom, Cooper, Scantronics etc.
PEU-I	1.0K	3.3K	3.3K	New Texecom, NetworX, Inim
PEU-J	12.0K	6.8K	4.7K	Risco ProSYS
PEU-K	2.2K	1.0K	1.0K	Siemens SPC

No warranty is given as to the fitness of this option with noted above manufacture's product. Please check on specifications of a control panel before you buy this option. Some models do not have a trouble output.

PRODUCT SPECIFICATIONS







OUTDOOR PROTECTION

INDOOR PROTECTION









REDWALL

ACCESS CONTROL

TECHNICAL INFORMATION

	FLX-A-AM	FLX-A-DAM	FLX-P-ST	FLX-P-DT	FLX-S-ST	FLX-S-DT	CX-702	
								
	P46	P46	P47	P47	P48	P48	P49	
Detection method	PIR	PIR & MW	PIR	PIR & MW	PIR	PIR & MW	PIR	
Coverage	15 x 15 m	15 x 15 m	15 x 15 m	15 x 15 m	12 x 12 m	12 x 12 m	21 x 21m	
Dual purpose lens / long range	24 x 2.4 m	24 x 2.4 m	24 x 2.4 m	24 x 2.4 m	18 x 2.4 m	18 x 2.4 m	45 x 2.4m	
Mounting height	2.0 to 3.0 m	2.0 to 3.0 m	2.0 to 3.0 m	2.0 to 3.0 m	2.0 to 3.0 m	2.0 to 3.0 m	1.5 to 3.6m	
Wall mount bracket	CW-G3	CW-G3	CW-G2	CW-G2	CW-G2	CW-G2	CA-1W	
Ceiling mount bracket	CW-G3	CW-G3	CW-G2	CW-G2	CW-G2	CW-G2	CA-2C	
Zoom function	—	—	—	—	—	—	—	
PIR sensitivity adjustment	SH / H / M / L	SH / H / M / L	H / M / L	H / M / L	H / M / L	H / M / L	—	
MW sensitivity adjustment	—	H / M / L	—	Long/Short	—	Long/Short	—	
Distance selector switch	Down Zone/Off	Down Zone/Off	—	—	—	—	—	
Double conductive shielding	✓	✓	✓	✓	—	—	✓	
Temperature compensation circuit	Digital (SMDA)	Digital (SMDA)	Digital (SMDA)	Digital (SMDA)	Digital (SMDA)	Digital (SMDA)	✓	
Power supply	9.5 to 16 VDC	9.5 to 16 VDC	9.5 to 16 VDC	9.5 to 16 VDC	9.5 to 16 VDC	9.5 to 16 VDC	9.5 to 16 VDC	
Current consumption	12 mA (normal) 16 mA (max.) at 12 VDC	16 mA (normal) 21 mA (max.) at 12 VDC	8 mA (normal) 11 mA (max.) at 12 VDC	11 mA (normal) 14 mA (max.) at 12 VDC	8 mA (normal) 11 mA (max.) at 12 VDC	11 mA (normal) 14 mA (max.) at 12 VDC	11 mA (max.) at 12 VDC	
Alarm output	N.C. 24 V DC 0.1 A max. (Resistive load)	N.C. 24 V DC 0.1 A max. (Resistive load)	N.C. 24 V DC 0.1 A max. (Resistive load)	N.C. 24 V DC 0.1 A max. (Resistive load)	N.C. 24 V DC 0.1 A max. (Resistive load)	N.C. 24 V DC 0.1 A max. (Resistive load)	N.C. 28 VDC 0.1 A max.	
Anti-masking function	✓	✓	—	—	—	—	—	
Self test	✓	✓	✓	✓	✓	✓	—	
Trouble output	N.C. 24 V DC 0.1 A max. (Resistive load)	N.C. 24 V DC 0.1 A max. (Resistive load)	—	—	—	—	—	
Tamper	✓	✓	✓	✓	✓	✓	✓	
Remote LED control	✓	✓	✓	✓	—	✓	—	
Operating Temperature	-20°C to +50°C	-20°C to +45°C	-20°C to +50°C	-20°C to +45°C	-20°C to +50°C	-20°C to +45°C	-20 to +50°C	
Environmental humidity	95% max.	95% max.	95% max.	95% max.	95% max.	95% max.	95% max.	
Dimensions (H x W x D mm)	159.1 x 62.2 x 55.7	159.1 x 62.2 x 55.7	129.2 x 61.5 x 50.9	129.2 x 61.5 x 50.9	129.2 x 61.5 x 50.9	129.2 x 61.5 x 50.9	140 x 100 x 69	
For residential					✓	✓		
For light commercial					✓	✓		
For commercial	✓	✓	✓	✓			✓	
For industrial	✓	✓					✓	
For wireless security system								

PRODUCT SPECIFICATIONS

	CX-702MKII	CX-702RS	SX-360Z	FX-360	AP-360B(C)	AP-360BR(C)	AP-20NB(C)	AP-20NBR(C)
								
	P49	P50	P51	P52	P53	P53	P54	P54
	PIR	PIR	PIR	PIR	PIR	PIR	PIR	PIR
	21 x 21m	21 x 21m	Ø18m 360°	Ø8m - 12m 360°	φ6 m 360°	φ6 m 360°	<Ceiling mount> 6 x 1 m <Wall mount> 6 x 4.5 m	<Ceiling mount> 6 x 1 m <Wall mount> 6 x 4.5 m
	45 x 10m	45 x 2.4	—	—	—	—	—	—
	1.5 to 3.6m	1.5 to 3.6m	2.4 to 5.0m	2.4 to 3.6m	2.5 to 4.5 m	2.5 to 4.5 m	<Ceiling mount> 2.5 to 4.5 m <Wall mount> Lower than 1.5 m	<Ceiling mount> 2.5 to 4.5 m <Wall mount> 1.5 m : Horizontal 1.0 m : Vertical
	CA-1W	CA-1W	—	—	—	—	—	—
	CA-2C	CA-2C	—	—	—	—	—	—
	—	—	✓	—	—	—	—	—
	—	—	H / M / L	—	H / M / L	H / M / L	H / M / L	H / M / L
	—	—	—	—	—	—	—	—
	—	—	—	—	—	—	—	—
	✓	✓	✓	—	—	—	—	—
	✓	✓	—	—	—	—	—	—
	9.5 to 16 VDC	3 to 9V alkaline or lithium battery	6 to 18 VDC	9.5 to 18 VDC	9.5 to 16 V DC	2.7 to 3.6 V DC (CR123A battery)	9.5 to 16 V DC	2.7 to 3.6 V DC (CR123A battery)
	11 mA (max.) at 12 VDC	5 μA (standby) 10 mA (walktest, LED on)	18mA max.	18mA max.	12 V DC Stand-by: 11mA, Max.: 13 mA	3 V DC Stand-by: 10μA, Max.: 4 mA	12 V DC Stand-by: 11mA, Max.: 13 mA	3 V DC Stand-by: 10μA, Max.: 4 mA
	N.C. 28 VDC 0.1 A max.	Form C 28 VDC 0.1 A max.	N.C. 28 VDC 0.2A max.	N.C. 28 VDC 0.2A max.	N.O./N.C., 28 V DC 200 mA max.	N.O./N.C., 3.6 V DC 10 mA max.	N.O./N.C., 28 V DC 200 mA max.	N.O./N.C., 3.6 V DC 10 mA max.
	—	—	—	—	—	—	—	—
	—	—	—	—	—	—	—	—
	—	—	—	—	—	—	—	—
	✓	✓	✓	✓	✓	✓	✓	✓
	—	—	✓	—	—	—	—	—
	-20 to +50°C	-10 to +50°C	-20 to +50°C	-20 to +50°C	-20 to +50°C	-20 to +50°C	-20 to +50°C	-20 to +50°C
	95% max.	95% max.	95% max.	95% max.	95% max.	95% max.	95% max.	95% max.
	140 x 100 x 69	140 x 100 x 69	Ø128 X 67-73	Ø128 X 37	< without switch box mount > ø52 x 42.5 mm < with 86-type box mount > 86 x 86 x 42.5 mm	< without switch box mount > ø52 x 42.5 mm < with 86-type box mount > 86 x 86 x 42.5 mm	< without switch box mount > ø52 x 35.5 mm < with 86-type box mount > 86 x 86 x 36.5 mm	< without switch box mount > ø52 x 35.5 mm < with 86-type box mount > 86 x 86 x 36.5 mm
			✓	✓	✓	✓	✓	✓
			✓	✓	✓	✓	✓	✓
	✓	✓	✓		✓	✓	✓	✓
	✓	✓	✓			✓		✓

OUTDOOR PROTECTION

INDOOR PROTECTION

REDWALL

ACCESS CONTROL

TECHNICAL INFORMATION

SIP-3020/4010/404

SYNTHESIZED INTELLIGENT PIR



OUTDOOR PROTECTION

INDOOR PROTECTION

REDWALL

ACCESS CONTROL

TECHNICAL INFORMATION



The SIP-3020, SIP-4010, and SIP-404 detectors in the REDWALL-V Series are designed for use in small and mid-sized outdoor areas. They have an intelligent detection system that uses data on the ambient environment, such as temperature and illuminance conditions, to automatically adjust the sensitivity.

FEATURES

- Intelligent PIR Detection System
 - Detection of ambient temperature and illuminance for automatic sensitivity management
 - Advanced detection algorithm
 - Three dual pyro-elements with Double Conductive Shielding
- Anti-vandalism functions
 - Anti-rotation function with 3-axis accelerometer
 - Anti-masking function with photo-beam
 - Reinforced polycarbonate housing
 - Max. 4m (13ft.) installation height
- Independent sensitivity selector for near/far areas
- Detection logic selector
- Detection range selector
- Independent N.C. and N.O. outputs
- Adjustable alarm interval time

COVERAGE

SIP-3020

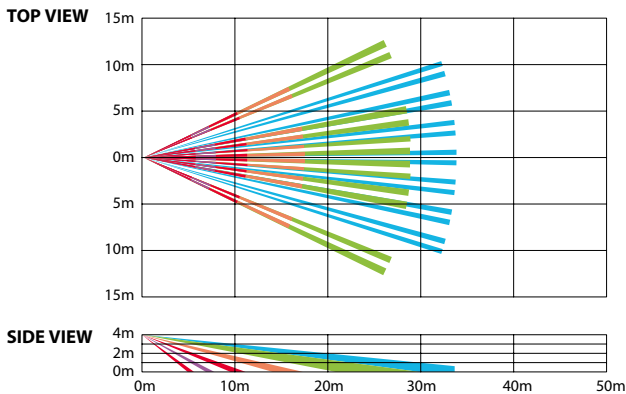

SIP-4010

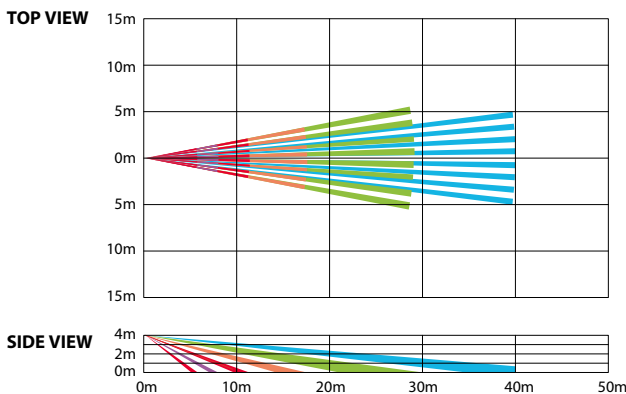

SIP-404

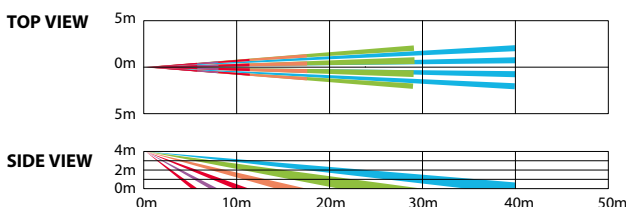

DIMENSIONS

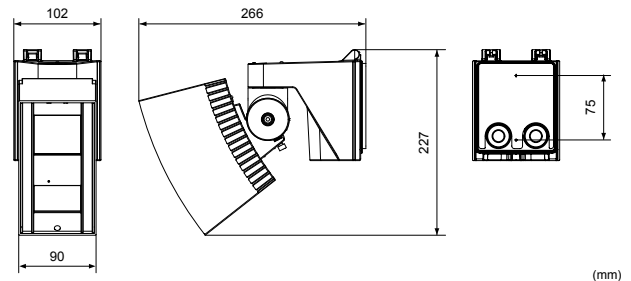

SPECIFICATIONS

Model	SIP-3020	SIP-4010	SIP-404
Detection method	Passive infrared		
PIR coverage (main area)	30 x 20 m	40 x 10 m	40 x 4 m
PIR coverage (creep zone)	-	-	-
Sensitivity selector	Far: SH/H/M/L Near: SH/H/M/L		
Range selector	Far: On/Off		
Detection logic selector	AND / OR		
Alarm interval period	Off/15, 30, 60 sec.		
Power input	11-26VDC 22-26VAC, 22-26VDC/AC with optional heating unit		
Current draw	40mA max. (12VDC) 75mA max. (24VAC), 415mA max. (24VAC) with optional heating unit		
Alarm period	Off/15, 30, 60 sec.		
Warm-up period	Approx. 60 sec.		
Alarm output	N.O., N.C., 28 VDC 0.2A max.		
Trouble output	N.C., 28 VDC 0.2 A max.		
Tamper output	N.C., 28 VDC 0.1 A max.		
Operating temperature	-25 to +60°C, -40 to +60°C with optional heating unit (-13 to +140°F, -40 to +140°F with optional heating unit)		
International protection	Main unit : IP65 Chassis : IP55		
Mounting height	2.3 to 4 m (7.6 to 13 ft.)		
Weight	1.2 kg (42 oz)		

Specifications and design are subject to change without prior notice.

OPTIONS

- AWT-3 : Area walk tester
- AVF-1 : Area view finder
- SIP-HU : Heating unit
- SIP-AT : SIP adjustment tools (AWT-3 + AVF-1)
- SIP-MINIHOOD : Sun/Snow shield

SIP-3020WF/4010WF/404WF

LOW CURRENT SYNTHESIZED INTELLIGENT PIR



The SIP-3020WF, SIP-4010WF and SIP-404WF are designed for use where a reliable low current detector is required.

FEATURES

- Low power consumption (3-9VDC, 40 A(standby) 5mA max.)
- Low battery signal
- Intelligent PIR Detection System
 - Detection of ambient temperature and illuminance for automatic sensitivity management
 - Advanced detection algorithm
 - Three dual pyro-elements with Double Conductive Shielding
- Anti-vandalism functions
 - Anti-rotation function with accelerometer
 - Anti-masking function with photo-beam
 - Reinforced polycarbonate housing
 - Max.4m (13 ft.) installation height
- Independent sensitivity selector for near/far areas
- Detection logic selector
- Detection range selector
- Independent N.C. and N.O. ALARM output
- Adjustable alarm interval time

COVERAGE

SIP-3020

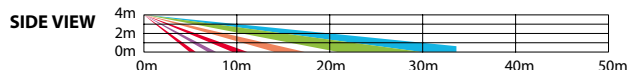
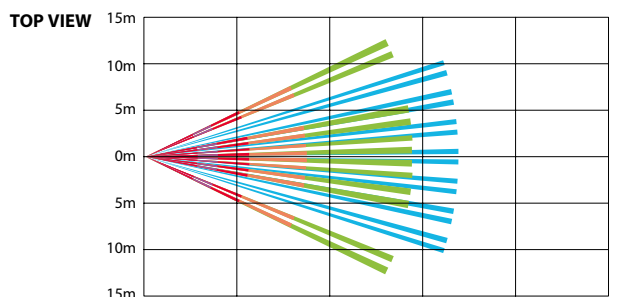

SIP-4010

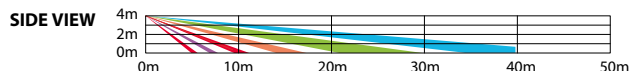
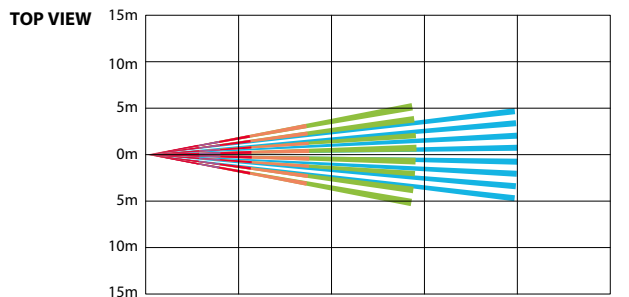

SIP-404

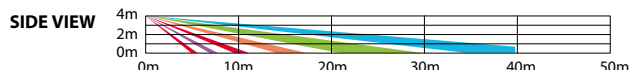
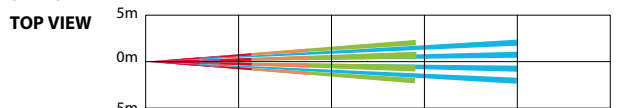

DIMENSIONS

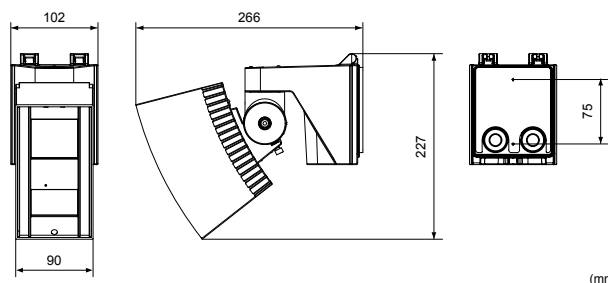

SPECIFICATIONS

Model	SIP-3020WF	SIP-4010WF	SIP-404WF
Detection method	Passive infrared		
PIR coverage (main area)	30 x 20 m	40 x 10 m	40 x 4 m
PIR coverage (creep zone)	-	-	-
Sensitivity selector	Far: SH/H/M/L Near: SH/H/M/L		
Range selector	Far: On/Off		
Detection logic selector	AND / OR		
Alarm interval period	Off/5, 60, 150 sec.		
Power input	3 to 9VDC Alkaline or lithium battery		
Current draw	40µA(Standby) 5mA max. (Operating LED ON)		
Alarm period	N.C. 10VDC, 0.01A max. N.O. 10VDC, 0.01A max.		
Warm-up period	Approx. 120 sec.		
Alarm output	Approx. 2 sec.		
Trouble output	N.C. 10VDC, 0.01A max.		
Tamper output	N.C. 10VDC, 0.01A max.		
Operating temperature	-25 to +60°C (-13°to +140°F)		
International protection	Main unit : IP65 Chassis : IP55		
Mounting height	2.3 to 4 m (7.6 to 13 ft.)		
Weight	1.2 kg (42 oz)		

Specifications and design are subject to change without prior notice.

OPTIONS

- AWT-3 : Area walk tester
- AVF-1 : Area view finder
- SIP-HU : Heating unit
- SIP-AT : SIP adjustment tools (AWT-3 + AVF-1)
- SIP-MINIHOOD : Sun/Snow shield

SIP-3020/5 SIP-4010/5 SIP-404/5

SYNTHESIZED INTELLIGENT PIR WITH CREEP ZONE



OUTDOOR PROTECTION

INDOOR PROTECTION

REDWALL

ACCESS CONTROL

TECHNICAL INFORMATION



The SIP-3020/5, SIP-4010/5 and SIP-404/5 are designed for detection applications outdoors to trigger video transmission systems and PTZ camera control.

FEATURES

- Intelligent PIR Detection System
 - Detection of ambient temperature and illuminance for automatic sensitivity management
 - Advanced detection algorithm
 - Three dual pyro-elements with Double Conductive Shielding for main area
- Built-in creep zone detector (Double dual pyro-elements)
- Anti-vandalism functions
 - Anti-rotation function with 3-axis accelerometer
 - Anti-masking function with photo-beam
 - Reinforced polycarbonate housing
 - Max. 4m (13ft.) installation height
- Independent sensitivity selector for creep/near/far areas
- Detection logic selector
- Detection range selector
- Independent N.C. and N.O. outputs
- Adjustable alarm interval time

COVERAGE

SIP-3020/5

TOP VIEW

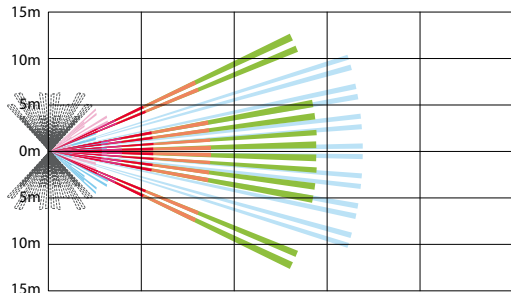

SIDE VIEW

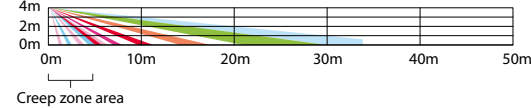

SIP-4010/5

TOP VIEW

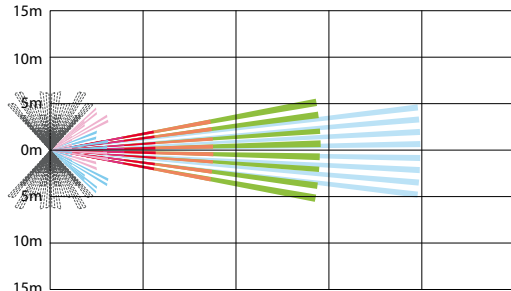

SIDE VIEW

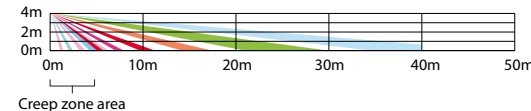

SIP-404/5

TOP VIEW

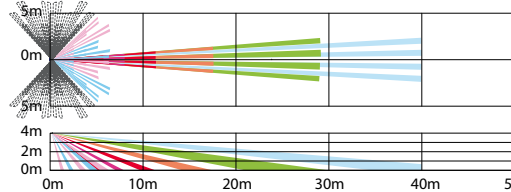

SIDE VIEW

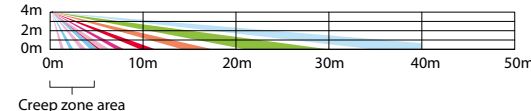

The detection angle of the creep zone can be adjusted $\pm 135^\circ$ horizontally as shown in gray.

DIMENSIONS

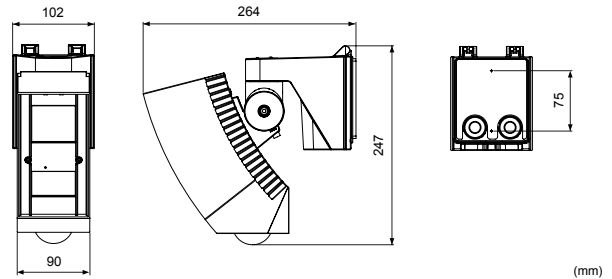

SPECIFICATIONS

Model	SIP-3020/5	SIP-4010/5	SIP-404/5
Detection method	Passive infrared		
PIR coverage (main area)	30 x 20 m	40 x 10 m	40 x 4 m
PIR coverage (creep zone)	3x 5m (10 x 16 ft.) installed at 2.3m (7.6 ft.) height, 6 x 9m (20 x 30 ft.) installed at 4m (13 ft.) height		
Sensitivity selector	Far: SH/H/M/L Near: SH/H/M/L Creep zone: SH/H/M/L		
Range selector	Far area: On/Off		
Detection logic selector	AND / OR		
Alarm interval period	Off/15, 30, 60 sec.		
Power input	11-26VDC 22-26VAC, 22-26VAC with optional heating unit		
Current draw	45mA max. (12VDC) 85mA max. (24VAC), 425mA max. (24VAC) with optional heating unit		
Alarm period	Approx. 2 sec.		
Warm-up period	Approx. 60 sec.		
Alarm output	(main area)N.O., N.C. 28VDC 0.2A max. (creep zone)N.O., N.C. 28VDC 0.2A max.		
Trouble output	N.C., 28 VDC 0.2 A max.		
Tamper output	N.C., 28 VDC 0.1 A max.		
Operating temperature	-25 to +60°C, -40 to +60°C with optional heating unit (-13 to +140°F, -40 to +140°F with optional heating unit)		
International protection	Main unit: IP65 Chassis: IP55		
Mounting height	2.3 to 4 m (7.6 to 13 ft.)		
Weight	1.4 kg (48 oz)		

Specifications and design are subject to change without prior notice.

OPTIONS

- AWT-3 : Area walk tester
- AVF-1 : Area view finder
- SIP-HU : Heating unit
- SIP-AT : SIP adjustment tools (AWT-3 + AVF-1)
- SIP-MINIHOOD : Sun/Snow shield

SIP-5030/100

SYNTHESIZED INTELLIGENT PIR WITH CREEP ZONE



FEATURES

- Intelligent PIR detection system
 - Detection of ambient temperature and illuminance for automatic sensitivity management
 - Advanced detection algorithm
 - Double Dual/One Quad pyro-elements with Double Conductive Shielding for main area SIP-5030
 - Double Quad pyro-elements with Double Conductive Shielding for main area SIP-100
- Built-in creep zone detector (Double dual pyro-elements)
- Anti-vandalism functions
 - Anti-rotation function with 3-axis accelerometer
 - Anti-masking function with photo-beam
 - Reinforced polycarbonate housing
 - Max. 4m (13ft.) installation height
- Independent sensitivity selector for creep/near/far areas
- Independent N.C. and N.O. output for main area SIP-5030
- 2 x N.C. and N.O. independent output for main areas (Near and Far areas) SIP-100
- Adjustable alarm interval time

The SIP-5030 offers wide angle-detection for large areas outside. It has an intelligent detection system that uses data from the ambient environment, such as temperature and illuminance conditions, to automatically adjust the sensitivity.

COVERAGE

SIP-5030

TOP VIEW

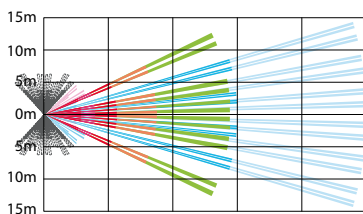

SIDE VIEW

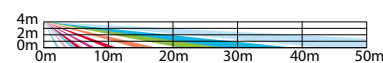

SIP-100

TOP VIEW

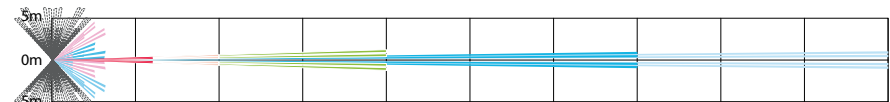

SIDE VIEW

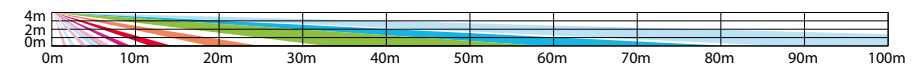

The detection angle of the creep zone can be adjusted $\pm 135^\circ$ horizontally as shown in gray.

DIMENSIONS

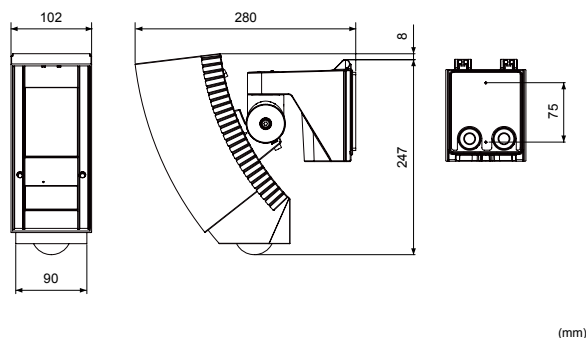

OPTIONS

- AWT-3 : Area walk tester
- AVF-1 : Area view finder
- SIP-HU : Heating unit
- SIP-AT : SIP adjustment tools (AWT-3 + AVF-1)
- SIP-MIDIHOOD : Sun/Snow shield

SPECIFICATIONS

Model	SIP-5030	SIP-100
Detection method	Passive infrared	
PIR coverage (main area)	50 x 30 m	100 x 3 m
PIR coverage (creep zone)	3x 5m (10 x 16 ft.) installed at 2.3m (7.6 ft.) height, 6 x 9m (20 x 30 ft.) installed at 4m (13 ft.) height	
Sensitivity selector	Far: SH/H/M/L Near: SH/H/M/L Creep zone: SH/H/M/L	
Range selector	-	
Detection logic selector	AND / OR	
Alarm interval period	Off/15, 30, 60 sec.	
Power input	11-26VDC 22-26 VAC, 22-26VDC/AC with optional heating unit	
Current draw	45mA max. (12VDC) 85mA max. (24VAC) 425mA max. (24VAC) with optional heating unit	50mA max. (12VDC) 90mA max. (24VAC) 430mA max. (24VAC) with optional heating unit
Alarm period	Approx. 2 sec.	
Warm-up period	Approx. 60 sec.	
Alarm output	(main area)N.O., N.C. 28VDC 0.2A max. (creep zone)N.O., N.C. 28VDC 0.2A max.	(main area)Far area:N.O., N.C. 28VDC 0.2A max. Near area:N.O., N.C. 28VDC 0.2A max. (creep zone)N.O., N.C. 28VDC 0.2A max.
Trouble output	N.C., 28 VDC 0.2 A max.	
Tamper output	N.C., 28 VDC 0.1 A max.	
Operating temperature	-25 to +60°C, -40 to +60°C with optional heating unit (-13 to +140°F, -40 to +140°F with optional heating unit)	
International protection	Main unit : IP65 Chassis : IP55	
Mounting height	2.3 to 4 m (7.6 to 13 ft.)	
Weight	1.6kg (56 oz)	

Specifications and design are subject to change without prior notice.

RLS-50100V/3060V

OUTDOOR 2D LIDAR SENSOR

REDFAN®

Advanced LiDAR sensor series
Long-range, intelligent, secure and customisable security outdoor and indoor laser sensors.

Available Models

- RLS-50100V 50 x 100 m (approx. 165 x 330 ft.)
- RLS-3060V 30 x 60 m (approx. 100 x 200 ft.)

FEATURES

- Full IP/PoE integration ready.
- Various security and product standard compliant.
- Vertical and Horizontal detection modes
- Built-in angle adjustment function
- Assistance Camera (2 MP, 170 degrees)
- Dynamic Event Filtering
- Event log function
- ONVIF profile S compliant
- Integration to external devices and applications with REDWALL Event Code
- Supporting network protocols : UDP/ TCP/ HTTP/ HTTPS/ IPV4/ IPV6/ DNS/ DHCP/ SNMPv1-v3/ NTP/ WS-Discovery/ ONVIF/ IEEE802.1X / REC (REDWALL Event Code)

COVERAGE

RLS-50100V

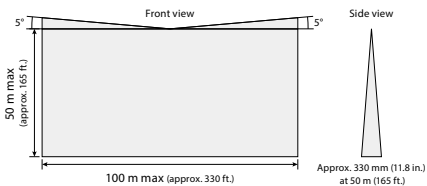

RLS-3060V

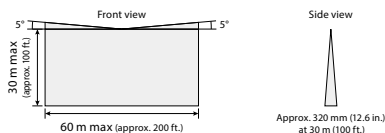

DIMENSIONS

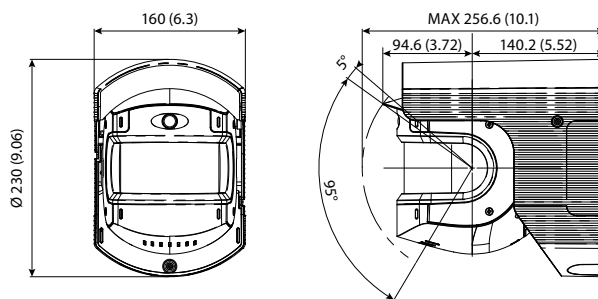

Unit:mm

OPTIONS

- LAC-1 : Laser Area Checker
- RLS-LWV : Replacement Window
- RLS-LWVH : Replacement Window with heater unit

SPECIFICATIONS

Model	RLS-50100V	RLS-3060V
Installation location	Indoor / Outdoor	
Detection method	Infrared Laser Scan	
Laser protection class	Class 1	
Power input	19.2-30 VDC, PoE+ (IEEE 802.3at compliant)	
Current draw	500 mA max. (24 VDC), 12 W max. (PoE+) with heater option: 1.25 A max. (24 VDC), 25.5 W max. (PoE+)	
Mounting method	Ceiling mount, Wall mount, Pole mount	
Detection area	50 x 100 m, 190 degree (approx. 165 x 330 ft.)	30 x 60 m, 190 degree (approx. 100 x 200 ft.)
Detection range	Radius 1 to 50 m (approx. 3.3 to 165 ft.) at 10% reflectivity	Radius 1 to 30 m (approx. 3.3 to 100 ft.) at 10% reflectivity
Detection resolution / Response time	0.125 degrees / within 100 msec. to 15 min.	
Mounting height (Vertical mode)	Indoor: 2 m (approx. 6.7 ft.) or higher/Outdoor: 4 m (approx. 13 ft.) or higher (Recommended)	
Communication port	Ethernet RJ-45 10BASE-T/100BASE-TX (Auto negotiation)	
Protocol	UDP/TCP/HTTP/HTTPS/IPV4/DNS/DHCP/SNMPv1-v3/NTP/WS-Discovery/ONVIF/IPV6/IEEE802.1X	
Output	6 outputs, 28 VDC 0.2A max. N.O./N.C. Selectable	
Input	1 Non-voltage contact input	
Alarm period	Approx. 2 second delay timer	
Operating temperature	-20°C to 60°C (-4°F to 140°F), -40°C to 60°C (-40°F to 140°F) with RLS-LWVH	
Dimensions (HxWxD), Weight	230 x 160 x 256.6 mm max. (9.1 x 6.3 x 10.1 inch), 2.6 kg (92 oz.)	
IP rating	IP66	
Image sensor	Full HD, 1080P (Web User Interface), 720P/360P (RTSP), H : 170°, V : 85°, Minimum approx. 1 lux., Removable infrared-cut filter (Auto / Night / Day)(selectable), H.264, JPEG, 1 to 30 fps (selectable)	

* The specifications refer to the Firmware ver. 2.0.0 or later.

* This product is equipped with the function to produce and record moving and/or still image which includes the information such as face of an individual that could identify the individual. Producing and recording with this product may be regulated by country-specific laws to protect personal information. Prior to the installation of this product, the compliance to local laws and regulations needs to be confirmed by the user of this product for the lawful installation and use of this product, and signage and notification when using this product.

RLS-2020V/A

OUTDOOR/INDOOR 2D LIDAR SENSOR

REDFAN®



Advanced 2D Lidar sensor for outdoor and indoor intrusion detection. Customizable zones and detection logic fully integrated with various VMS platforms.

Available Models

- RLS-2020V 20 x 20 m (approx. 65 x 65 ft.) detection with FHD camera
- RLS-2020A 20 x 20 m (approx. 65 x 65 ft.) detection

FEATURES

- 20m x 20m (65ft. x 65ft.), 95 degree detection area
- Vertical and Horizontal detection modes
- Built-in FHD Camera and IR LED
- Map Screen Display
- Dynamic Event Filtering
- Automatic IR Adjustment
- Event log function
- ONVIF profile S compliant
- Supporting network protocols : UDP/ TCP/ HTTP/HTTPS/ IPV4/ IPV6/ DNS/ DHCP/ SNMPv1-v3/ NTP/WS-Discovery/ ONVIF/ IEEE802.1X/ REC (REDWALL Event Code)

COVERAGE

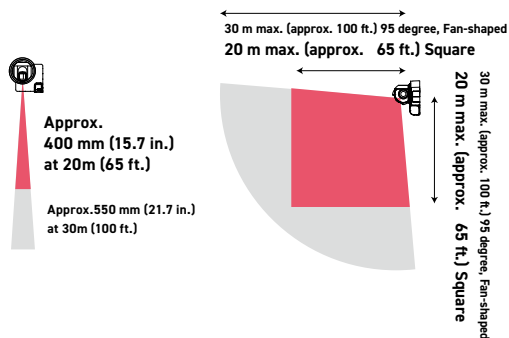

DIMENSIONS

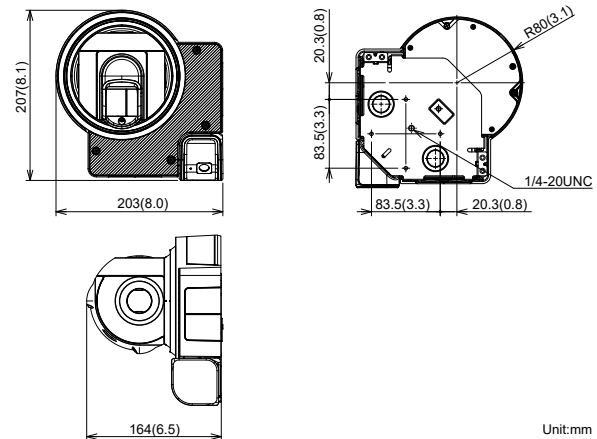

Unit:mm

OPTIONS

- LAC-1 : Laser Area Checker
- RLS-LW : Laser window for replacement
- RLS-PB2 : Pole mount Bracket

SPECIFICATIONS

Model	RLS-2020V	RLS-2020A
Installation location	Indoor/Outdoor	
Detection method	TOF	
Laser protection class	Class 1	
Power input	19.2-30 VDC, PoE+ (IEEE 802.3at compliant)	19.2-30 VDC, PoE (IEEE 802.3af compliant)
Current draw	580 mA max. (24 VDC), 14 W max. (PoE+)	500 mA max. (24 VDC), 12 W max. (PoE)
Mounting method	Ceiling mount, Wall mount, Pole mount	
Detection area	20 x 20m, 95 degree (approx. 65 x 65 ft.)	
Detection range	Radius 1 to 21 m (approx. 3.3 to 68 ft.) at 10% reflectivity	
Detection resolution/Response time	0.125 degrees / within 50 msec. to 15 min. / 0.25 degrees / within 75 msec. to 15 min.	
Mounting height (Vertical mode)	Indoor: 2 m (approx. 6.7 ft.) or higher / Outdoor: 4 m (approx. 13 ft.) or higher (recommended)	
Communication interface	2 Ethernet RJ-45 10BASE-T/100BASE-TX (Auto negotiation) RS-485	
Protocol	UDP/ TCP/ HTTP/ HTTPS/ IPV4/ IPV6/ DNS/ DHCP/ SNMPv1-v3/ NTP/ WS-Discovery/ ONVIF/ IEEE802.1X	
Output	6 outputs, 28 VDC 0.2 A max. N.O./N.C.(selectable) (6 from Master alarm, Zone alarm, Trouble, Tamper, Environmental Disqualification, Device Monitoring) (programmable)	
Input	2 Non-voltage contact input (Detection profile switching, Area set, Sensor check) (programmable)	
Alarm period	Approx. 2 second delay timer	
Operating temperature	-40°C to 60°C (-40°F to 140°F)	
IP rating	IP66	
Dimensions (H x W x D)	207 x 203 x 164 mm max. (8.1 x 8.0 x 6.5 inch)	
Weight	1.6 kg (3.5 lbs.)	1.3 kg (2.9 lbs.)
Image sensor	1/2.8" CMOS	
Image resolution	1080P/720P/360P (RTSP H.264) 720P/360P (RTSP JPEG) (Supports portrait display)	
Viewing angle	H:130° V:65°	
Minimum illumination	Approx. 1 lux. Less than the above, IR LEDs turn on.	
Day and night	Automatically removable infrared-cut filter. Auto/Day/Night mode selectable	
Image compression	H.264, JPEG	
Frame rate	1 to 10 FPS (selectable)	

* Specifications and design are subject to change without prior notice.

* RLS-2020V is equipped with the function to produce and record moving and/or still image which includes the information such as face of an individual that could identify the individual. Producing and recording with this product may be regulated by country-specific laws to protect personal information. Prior to the installation of this product, the compliance to local laws and regulations needs to be confirmed by the user of this product for the lawful installation and use of this product, and signage and notification when using this product.

OUTDOOR PROTECTION

INDOOR PROTECTION

REDWALL

ACCESS CONTROL

TECHNICAL INFORMATION

RLS-3060L/SH

LASER SCAN DETECTOR

REDFSCAN®



The RLS-3060 series is a laser scan detector that identifies a moving object's size, speed and distance from the detector. It processes that information with a unique algorithm, resulting in a highly reliable detection system with minimal false alarms.

FEATURES

- 30m radius for 190 degrees range
- Vertical and horizontal mounting
- Unique detection algorithm
- Automatic area setting function
- 4 independently adjustable detection areas and 4 dry contact outputs for PTZ control or
- 8 independently adjustable detection areas and REDWALL Event Code for Network
- Integration to external devices and applications with REDWALL Event Code
- Changeable Dry-contact Alarm Output type N.O. to N.C.
- Fog cancellation algorithm (Patent listed)

COVERAGE

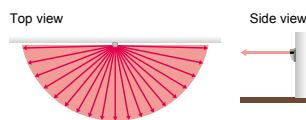
Image of horizontal detection area



Side view



Image of horizontal detection area

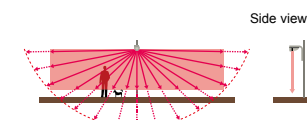

Side view



Vertical detection area example



Horizontal detection area example

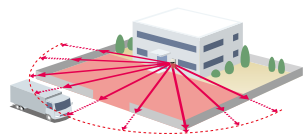

OPTIONS

- RLS-PB : Pole mount bracket
- RLS-SB : Adjustable angle mounting bracket
- LAC-1 : Laser Area Checker

DIMENSIONS

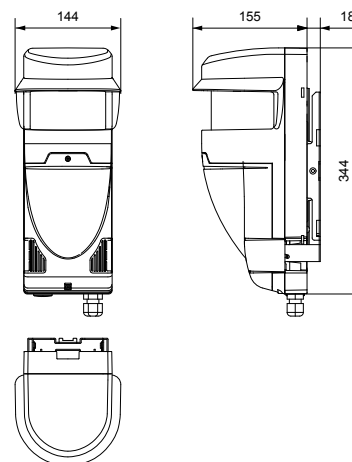

Unit:mm

SPECIFICATIONS

Model		RLS-3060L	RLS-3060SH
Detection method		Infrared Laser Scan	
Laser protection class		Class 1	
Coverage	Vertical area	Max. 60 m (Approx. 200 ft.) at 10% reflectivity	Max. 60 m (Approx. 200 ft.) at 10% reflectivity / Detection range expansion enable max. 100 m (Approx. 330 ft.).
	Horizontal area	Radius:30m (Approx. 100 ft.), Arc:190° at 10% reflectivity	Radius:30 m (Approx. 100 ft.), Arc:190° at 10% reflectivity / Detection range expansion enable radius:50 m (Approx. 165 ft.), Arc:190°.
Detection resolution		0.25°	
Communication port		Ethernet ,RJ-45 ,10BASE-T/100BASE-TX	
Protocol		UDP, TCP/IP *Redwall Event Code	
Power input		24 VDC 24 VAC	
Current draw		400mA max. (24VDC) 600mA max. (24VAC)	
Heater power input		-	24 VDC, 24 VAC
Heater current draw		-	400mA max. (24 V DC/AC)
Mounting height	Vertical area	15m (50ft.) max.	
	Horizontal area	0.7m (28in.) (recommended)	
Target object selector		S / M / L	
Sensitivity selector		H / M / L	
Camera control output		N.O. 28 VDC, 0.2 A x 4 outputs / Can be changeable to N.C. with RSM ver.8.	
Master alarm output		Form C, 28 VDC, 0.2 A max.	
Trouble output		Form C, 28 VDC, 0.2 A max.	
Tamper output		N.C. 28 VDC, 0.1 A max.	
Environmental disqualification circuit		Form C, 28 VDC, 0.2 A max.	
Alarm period		Approx. 2 sec., Off delay timer	
Operating temperature		-20 to 60 °C (-4 to 140 °F)	
Operating temperature with heater		-40 to 60 °C (-40 to 140° F)	
IP rating		IP66	
Dimensions (H x W x D)		334 x 144 x 155 mm (13.2 x 5.7 x 6.1 in.)	
Weight		2.4kg (85 oz.)	

Specifications and design are subject to change without prior notice.

RLS-2020I/S

LASER SCAN DETECTOR

REDFSCAN mini™



The RLS-2020 series is a compact and highly customizable laser scan detector that helps protect in an unobstructed way, houses, buildings, flat roofs, controlled areas and assets by creating an invisible laser wall or plane and detecting any intrusion breaching it.

FEATURES

- 20m x 20m (65ft. x 65ft.), 95 degree detection area
- Vertical and Horizontal detection modes
- Multi-angle Adjustment Shell Structure (M.A.S.S.)
- Unique detection algorithm
- Automatic area setting function
- Advanced area setting
- 4 adjustable detection areas on IP connection
- Total 3 outputs can be assigned for analog connection
- Integration to external devices and applications with REDWALL Event Code.
- Supporting multiple network protocols, e. g. TCP/IP, UDP/IP, DHCP, DNS, HTTP, HTTPS, FTP, SNMPv1/v2c/v3, ICMP, ARP.

COVERAGE

Vertical

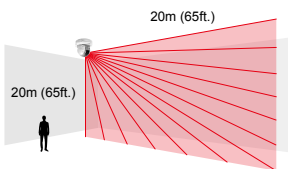

Horizontal

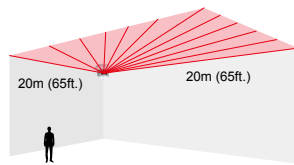

DIMENSIONS

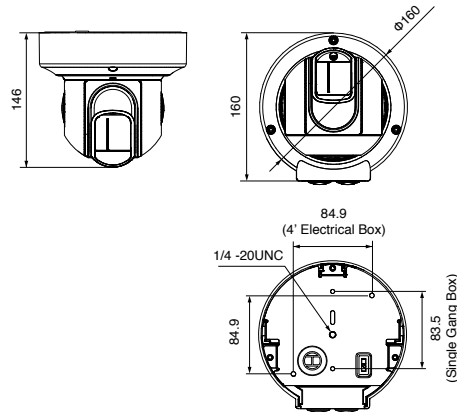

Unit:mm

OPTIONS

- RLS-AT : RLS area Adjustment Tool Kit
- LAC-1 : Laser Area Checker
- RLS-PB : Pole mount Bracket
- RLS-RB : Recess mount bracket
- RLS-LW : Laser Window

SPECIFICATIONS

Model	RLS-2020I	RLS-2020S
Installation location	Indoor	Indoor/Outdoor
Detection method	Infrared Laser Scan	
Laser protection class	Class 1	
Power input	10.5 to 30 VDC, PoE (IEEE802.3 af/at compliant)	
Current draw	500 mA max. (12 VDC), 250 mA max. (24 VDC), 6W max. (PoE)	
Mounting method	Ceiling mount, Wall mount, Tripod mount, Pole mount (Option), Recess mount (Option)	
Detection area	20 x 20 m, (approx. 65 x 65 ft.), 95 degrees	
Detection range	Radius 1 to 21m (approx. 3.3 to 68 ft.) at 10% reflectivity	
Detection resolution/Response time	0.25 degrees / within 75 ms to 15 minute	0.25 degree / within 75msec to 15 minutes (for indoor mode and outdoor mode) 0.25 degree / within 25msec (for indoor throw-in mode), 0.125 degree / within 100msec to 15 minutes (for Indoor high resolution mode)
Mounting height(Vertical mode)	2 m (6.7 ft.) or higher	Indoor: 2 m (6.7 ft.) or higher Outdoor: 4 m (13 ft.) or higher (Recommended)
Communication port	Ethernet RJ-45 10BASE-T/100BASE-TX (Auto negotiation)	
Network protocol	TCP/IP, UDP/IP, DHCP, DNS, HTTP, HTTPS, FTP, SNMPv1/v2c/v3, ICMP, ARP	
Output	3 outputs, 28 VDC 0.2 A max. N.O./N.C. Selectable (3 from Master alarm, Zone outputs, Trouble, Tamper)	3 outputs, 28 VDC 0.2 A max. N.O./N.C. Selectable (3 from Master alarm, Zone outputs, Trouble, Tamper, D.Q.)
Input	1 Non-voltage contact input	
Alarm period	Approx. 2 sec delay timer	
Operating temperature	-40 to 50 C degrees (-40 to 122 F degrees)	-40 to 60 C degrees (-40 to 140 F degrees)
IP rating	IP66	
Dimensions (HxWxD)	146 x 160 x 160 mm (5.8 x 6.3 x 6.3 inch)	
Weight	1.0 kg (2.2 lb)	

Specifications and design are subject to change without prior notice.

PIE-1

PoE IP ENCODER



PIE-1 is an encoder that converts analog relay outputs to original ASCII code (Redwall Event Code) for Redwall and Fiber SenSys detectors. Detectors can be connected to Video Management Software platforms with PIE-1 and control IP cameras.

PIE-1 is generating Redwall Event Code using the analog alarm inputs from the Redwall and Fiber SenSys detectors. Video Management Software receives the event code and sends a command to reposition to a pre-set and/or start recording with a camera.

PIE-1 is compatible with Power over Ethernet (PoE). IEEE802.3 af/at making it possible to supply power using a PoE hub or switch.

Only one LAN cable is needed to connect PIE-1 to a PoE hub or switch reducing your installation time and cost.

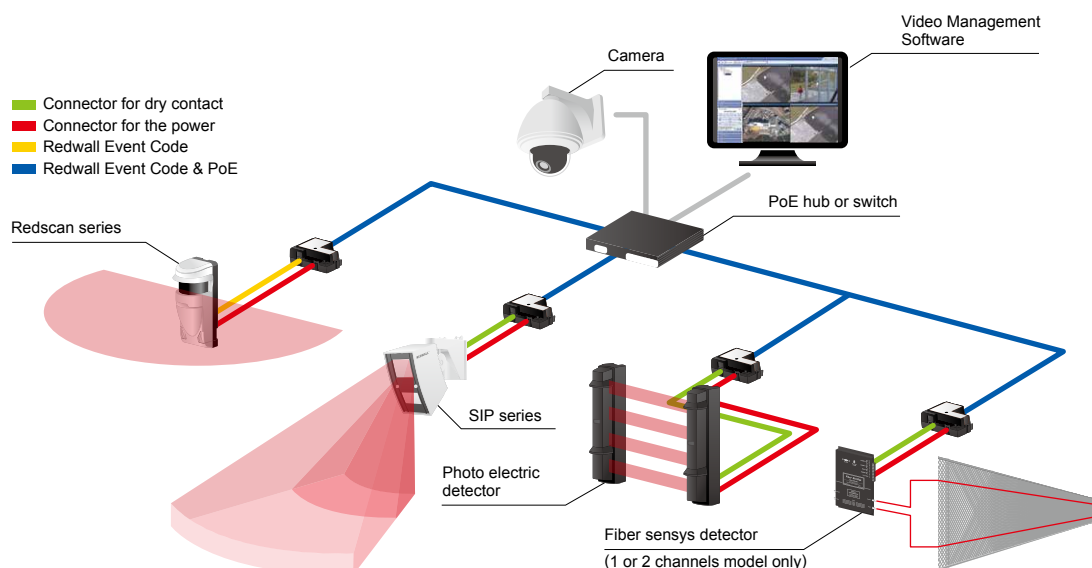

FEATURES

- Change Analog to IP
- PIE-1 changes analog relay output signals (N.C.) to original ASCII code.

- Compatible with Power over Ethernet
- PIE-1 can supply power to detector using a PoE hub or switch.

DIMENSIONS

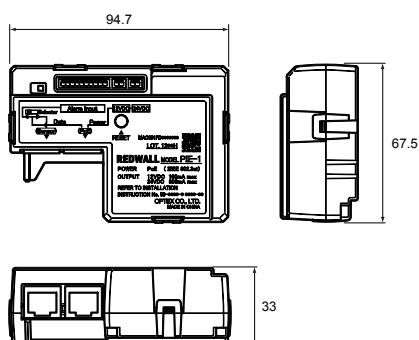

(mm)

SPECIFICATIONS

Model	PIE-1
Power supply	PoE (IEEE802.3af/at compliant)
Power output	24 VDC 800 mA max, 12 VDC 50 mA max
Signal input	5 input for dry contacts (N.C. only)
Place of use	Outdoor (Inside of the waterproof case)
Alarm output	Redwall Event Code (UDP / TCP)
Operating temperature	-40 to +60 (-40 to +140)
Operating humidity	95%RH. max
Operation LED (Normal)	Green light is ON when the power is supplied by PoE
Operation LED (When communicating)	Yellow light blinks during communication
Switch	Ethernet converter / LAN through
Function setting	Use web browser
Dimension	67.5 mm x 94.7 mm x 33 mm (3.66" x 3.73" x 1.30")
Weight	270 g (8.8 oz: including all parts) Main unit: 90 g (3.2 oz)
Supported protocols	IPv4, ARP, UDP, TCP, ICMP, HTTP
Accessories	Power output cable x2, Alarm input cable x3, Installation instruction, Mounting plate for a Double Gang Box, Gasket sheet for Gang Box, Mounting Screws x6

Specifications and design are subject to change without prior notice.

OPTIONS

REDWALL

AWT-3

Area walk tester
for SIP series



AVF-1

Area view finder
for SIP series



SIP-HU

Heating unit
for SIP series



SIP-AT

SIP adjustment tools
(AWT-3 + AVF-1)
for SIP series



SIP-MINIHOOD

Sun/Snow shield
for SIP-3020/4010/404

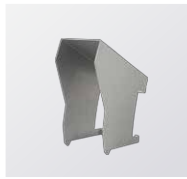

SIP-MIDIHOOD

Sun/Snow shield
for SIP-5030/100

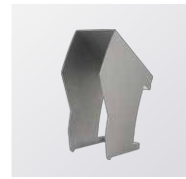

REDFWALL

RLS-PB

Pole mount bracket
for all SIP series and
all RLS series



RLS-SB

Adjustable angle
mounting bracket
for RLS-3060 series



RLS-LW

Laser Window
for RLS-2020 series



LAC-1

Laser Area Checker
for RLS-2020/3060



RLS-RB

Recess mount bracket
for RLS-2020



RLS-LWV

Replacement Window
for RLS-3060V
RLS-50100V



RLS-LWVH

Replacement Window
with heater unit
for RLS-3060V
RLS-50100V



RLS-PB2

Pole mount Bracket



PRODUCT SPECIFICATIONS









OUTDOOR PROTECTION



INDOOR PROTECTION



REDWALL/REDSAN

ACCESS CONTROL



TECHNICAL INFORMATION



	SIP-3020	SIP-4010	SIP-404	SIP-3020WF	SIP-4010WF	SIP-404WF	SIP-3020/5	SIP-4010/5	SIP-404/5
									
	P58	P58	P58	P59	P59	P59	P60	P60	P60
Detection method	Passive infrared			Passive infrared			Passive infrared		
PIR coverage (main area)	30 x 20 m	40 x 10 m	40 x 4 m	30 x 20 m	40 x 10 m	40 x 4 m	30 x 20 m	40 x 10 m	40 x 4 m
PIR coverage (creep zone)	—	—	—	—	—	—	3x 5m (10 x 16 ft.) installed at 2.3m (7.6 ft.) height, 6 x 9m (20 x 30 ft.) installed at 4m (13 ft.) height		
Sensitivity selector	Far: SH/H/M/L Near: SH/H/M/L			Far: SH/H/M/L Near: SH/H/M/L			Far: SH/H/M/L Near: SH/H/M/L Creep zone: SH/H/M/L		
Range selector	Far: On/Off			Far: On/Off			Far area: On/Off		
Detection logic selector	AND / OR			AND / OR			AND / OR		
Alarm interval period	Off/15, 30, 60 sec.			Off/5, 60, 150 sec.			Off/5, 60, 150 sec.		
Power input	11-26VDC 22-26VAC, 22-26VDC/AC with optional heating unit			3 to 9VDC Alkaline or lithium battery			11-26VDC 22-26VAC, 22-26VDC with optional heating unit		
Current draw	40mA max. (12VDC) 75mA max. (24VAC), 415mA max. (24VAC) with optional heating unit			40µA(Standby) 5mA max. (Operating LED ON) N.C. 10VDC, 0.01A max. N.O. 10VDC, 0.01A max.			40µA(Standby) 5mA max. (Operating LED ON) N.C. 10VDC, 0.01A max. N.O. 10VDC, 0.01A max.		
Alarm period	Off/15, 30, 60 sec.			Approx. 2 sec.			Approx. 2 sec.		
Warm-up period	Approx. 60 sec.			Approx. 120 sec.			Approx. 120 sec.		
Alarm output	N.O., N.C., 28 VDC 0.2A max.						(main area)N.O., N.C. 28VDC 0.2A max. (creep zone)N.O., N.C. 28VDC 0.2A max.		
Trouble output	N.C., 28 VDC 0.2 A max.			N.C. 10VDC, 0.01A max.			N.C., 28 VDC 0.2 A max.		
Tamper output	N.C., 28VDC 0.1 A max.			N.C. 10VDC, 0.01A max.			N.C., 28VDC 0.1 A max.		
Operating temperature	-25 to +60°C, -40 to +60°C with optional heating unit (-13 to +140°F, -40 to +140°F with optional heating unit)			-25 to +60°C (-13°to +140°F)			-25 to +60°C, -40 to +60°C with optional heating unit (-13 to +140°F, -40 to +140°F with optional heating unit)		
International protection	Main unit : IP65 Chassis : IP55			Main unit : IP65 Chassis : IP55			Main unit : IP65 Chassis : IP55		
Mounting height	2.3 to 4 m (7.6 to 13 ft.)			2.3 to 4 m (7.6 to 13 ft.)			2.3 to 4 m (7.6 to 13 ft.)		
Weight	1.2 kg (42 oz)			1.2 kg (42 oz)			1.4 kg (48 oz)		



	RLS-2020V	RLS-2020A
		
	P63	P63
Installation location	Indoor/Outdoor	
Detection method	TOF	
Laser protection class	Class 1	
Power input	19.2-30 VDC, PoE+ (IEEE 802.3at compliant)	19.2-30 VDC, PoE (IEEE 802.3af compliant)
Current draw	580 mA max. (24 VDC), 14 W max. (PoE+)	500 mA max. (24 VDC), 12 W max. (PoE)
Mounting method	Ceiling mount, Wall mount, Pole mount	
Detection area	20 x 20m, 95 degree (approx. 65 x 65 ft.)	
Detection range	Radius 1 to 21 m (approx. 3.3 to 68 ft.) at 10% reflectivity	
Detection resolution /Response time	0.125 degrees / within 50 msec. to 15 min. / 0.25 degrees / within 75 msec. to 15 min.	
Mounting height (Vertical mode)	Indoor: 2 m (approx. 6.7 ft.) or higher / Outdoor: 4 m (approx. 13 ft.) or higher (recommended)	
Communication interface	2 Ethernet RJ-45 10BASE-T/100BASE-TX (Auto negotiation) RS-485	
Protocol	UDP/ TCP/ HTTP/ HTTPS/ IPV4/ IPV6/ DNS/ DHCP/ SNMPv1-v3/ NTP/ WS-Discovery/ ONVIF/ IEEE802.1X	
Output	6 outputs, 28 VDC 0.2 A max. N.O./N.C.(selectable) (6 from Master alarm, Zone alarm, Trouble, Tamper, Environmental Disqualification, Device Monitoring) (programmable)	
Input	2 Non-voltage contact input (Detection profile switching, Area set, Sensor check) (programmable)	
Alarm period	Approx. 2 second delay timer	
Operating temperature	-40°C to 60°C (-40°F to 140°F)	
IP rating	IP66	
Dimensions (HxWxD)	207 x 203 x 164 mm max. (8.1 x 8.0 x 6.5 inch))	
Weight	1.6 kg (3.5 lbs.)	1.3 kg (2.9 lbs.)
Image sensor	1/2.8" CMOS	
Image resolution	1080P/720P/360P (RTSP H.264) 720P/360P (RTSP JPEG) (Supports portrait display)	—
Viewing angle	H:130° V:65°	
Minimum illumination	Approx. 1 lux. Less than the above, IR LEDs turn on.	
Day and night	Automatically removable infrared-cut filter. Auto/Day/Night mode selectable	
Image compression	H.264, JPEG	
Frame rate	1 to 10 FPS (selectable)	

	RLS-3060L	RLS-3060SH
		
	P64	P64
Detection method	Infrared Laser Scan	
Laser protection class	Class 1	
Coverage	Vertical area	Max. 60 m (Approx. 200 ft.) at 10% reflectivity Detection range expansion enable max. 100 m (Approx. 330 ft.)
	Horizontal area	Radius:30m (Approx. 100 ft.), Arc:190° at 10% reflectivity Radius:30m (Approx. 100 ft.), Arc:190° at 10% reflectivity / Detection range expansion enable radius:50 m (Approx. 165 ft.), Arc:190°.
Detection resolution	0.25°	
Communication port	Ethernet ,RJ-45 ,10BASE-T/100BASE-TX	
Protocol	UDP, TCP/IP *Redwall Event Code	
Power input	24 VDC 24 VAC	
Current draw	400mA max. (24VDC)	600mA max. (24VAC)
Heater power input	24 VDC, 24 VAC	
Heater current draw	400mA max. (24 V DC/AC)	
Mounting height	Vertical area	15m (50ft.) max.
	Horizontal area	0.7m (28in.) (recommended)
Target object selector	S / M / L	
Sensitivity selector	H / M / L	
Camera control output	N.O. 28 VDC, 0.2 A x 4 outputs / Can be changeable to N.C. with RSM ver.8.	
Master alarm output	Form C, 28 VDC, 0.2 A max.	
Trouble output	Form C, 28 VDC, 0.2 A max.	
Tamper output	N.C. 28 VDC, 0.1 A max.	
Environmental disqualification circuit	Form C, 28 VDC, 0.2 A max.	
Alarm period	Approx. 2 sec., Off delay timer	
Operating temperature	-20 to 60 °C (-4 to 140 °F)	
Operating temperature with heater	-40 to 60 °C (-40 to 140 °F)	
IP rating	IP66	
Dimensions (H x W x D)	334 x 144 x 155 mm (13.2 x 5.7 x 6.1 in.)	
Weight	2.4kg (85 oz.)	

PRODUCT SPECIFICATIONS

SIP-5030		SIP-100	
			
P61		P61	
Passive infrared			
50 x 30 m		100 x 3 m	
3x 5m (10 x 16 ft.) installed at 2.3m (7.6 ft.) height, 6 x 9m (20 x 30 ft.) installed at 4m (13 ft.) height			
Far: SH/H/M/L			
Near: SH/H/M/L Creep zone: SH/H/M/L			
—			
AND / OR			
Off/15, 30, 60 sec.			
11-26VDC 22-26 VAC, 22-26VDC/AC with optional heating unit			
45mA max. (12VDC) 85mA max. (24VAC), 425mA max. (24VAC) with optional heating unit		50mA max. (12VDC) 90mA max. (24VAC), 430mA max. (24VAC) with optional heating unit	
Approx. 2 sec.			
Approx. 60 sec.			
(main area) N.O., N.C. 28VDC 0.2A max. (creep zone) N.O., N.C. 28VDC 0.2A max.		(main area) Far area: N.O., N.C. 28VDC 0.2A max. Near area: N.O., N.C. 28VDC 0.2A max (creep zone) N.O., N.C. 28VDC 0.2A max.	
N.C., 28 VDC 0.2 A max.			
N.C., 28VDC 0.1 A max.			
-25 to +60°C, -40 to +60°C with optional heating unit (-13 to +140°F, -40 to +140°F with optional heating unit)			
Main unit : IP65 Chassis : IP55			
2.3 to 4 m (7.6 to 13 ft.)			
1.6kg (56 oz)			

RLS-50100V		RLS-3060V	
			
P62		P62	
Indoor / Outdoor			
Infrared Laser Scan			
Class 1			
19.2-30 VDC, PoE+ (IEEE 802.3at compliant) 500 mA max. (24 VDC), 12 W max. (PoE+) with heater option: 1.25 A max. (24 VDC), 25.5 W max. (PoE+)			
Ceiling mount, Wall mount, Pole mount			
50 x 100 m, 190 degree (approx. 165 x 330 ft.)		30 x 60 m, 190 degree (approx. 100 x 200 ft.)	
Radius 1 to 50 m (approx. 3.3 to 165 ft.) at 10% reflectivity		Radius 1 to 30 m (approx. 3.3 to 100 ft.) at 10% reflectivity	
0.125 degrees / within 100 msec. to 15 min.		0.25 degrees / within 100 msec. to 15 min.	
Indoor: 2 m (approx. 6.7 ft.) or higher/ Outdoor: 4 m (approx. 13 ft.) or higher (Recommended)			
Ethernet RJ-45 10BASE-T/100BASE-TX (Auto negotiation)			
UDP/TCP/HTTP/HTTPS/IPV4/DNS/DHCP/SNMPv1-v3/ NTP/WS-Discovery/ONVIF/IPV6/IEEE802.1X			
6 outputs, 28 VDC 0.2A max. N.O./N.C. Selectable			
1 Non-voltage contact input			
Approx. 2 second delay timer			
-40°C to 60°C (-40°F to 140°F) with RLS-LWVH: -20 °C to 60°C (-140°F to 140°F)			
230 × 160 × 256.6 mm max. (9.1 x 6.3 x 10.1 inch), 2.6 kg (92 oz.)			
IP66			

RLS-2020I		RLS-2020S	
			
P65		P65	
Indoor		Indoor/Outdoor	
Infrared Laser Scan			
Class 1			
10.5 to 30 VDC, PoE (IEEE802.3af/at compliant)			
500 mA max. (12 VDC), 250 mA max. (24 VDC), 6W max. (PoE)			
Ceiling mount, Wall mount, Tripod mount, Pole mount (Option), Recess mount (Option)			
20 x 20 m, (approx. 65 x 65 ft.), 95 degrees			
Radius 1 to 21m (approx. 3.3 to 68 ft.) at 10% reflectivity			
0.25 degrees / within 75 ms to 15 minute		0.25 degree / within 75msec to 15 minutes (for indoor mode and outdoor mode) 0.25 degree / within 25msec (for indoor throw-in mode), 0.125 degree / within 100msec to 15 minutes (for Indoor high resolution mode)	
2 m (6.7 ft.) or higher		Indoor: 2 m (6.7 ft.) or higher Outdoor: 4 m (13 ft.) or higher (Recommended)	
Ethernet RJ-45 10BASE-T/100BASE-TX (Auto negotiation)			
TCP/IP, UDP/IP, DHCP, DNS, HTTP, HTTPS, FTP, SNMPv1/v2c/v3, ICMP, ARP			
3 outputs, 28 VDC 0.2 A max. N.O./N.C. Selectable (3 from Master alarm, Zone outputs, Trouble, Tamper)		3 outputs, 28 VDC 0.2A max. N.O./N.C. Selectable (3 from Master alarm, Zone outputs, Trouble, Tamper, D.Q.)	
1 Non-voltage contact input			
Approx. 2 sec delay timer			
-40 to 50 C degrees (-40 to 122 F degrees)		-40 to 60 C degrees (-40 to 140 F degrees)	
IP66			
146 x 160 x 160 mm (5.8 x 6.3 x 6.3 inch)			
1.0 kg (2.2 lb)			

PIE-1	
	
P66	
PoE (IEEE802.3af/at compliant)	
24 VDC 800 mA max, 12 VDC 50 mA max	
5 input for dry contacts (N.C. only)	
Redwall Event Code (UDP / TCP)	
-40 to +60°C (-40 to +140 °F)	
95%RH. max	
Green light is ON when the power is supplied by PoE	
Yellow light blinks during communication	
Ethernet converter / LAN through	
Use web browser	
67.5 mm x 94.7 mm x 33 mm (3.66" x 3.73" x 1.30")	
270 g (8.8 oz: including all parts) Main unit: 90 g (3.2 oz)	
IPV4, ARP, UDP, TCP, ICMP, HTTP	
Power output cable x2, Alarm input cable x3, Installation instruction, Mounting plate for a Double Gang Box, Gasket sheet for Gang Box, Mounting Screws x6	

OUTDOOR PROTECTION

INDOOR PROTECTION

REDWALL/REDFAN

ACCESS CONTROL

TECHNICAL INFORMATION

OV-102S(E) [Detection unit] / OV-102CB(E) [Control box]

ANTI-TAILGATING SYSTEM



Unique algorithm for anti-tailgating detection

[Vector focal method]

The Accurance OV-102 grasps and tracks a shape of human sterically by a unique image sensing technology.

The system can recognize complicated movement and the number of people at high rate and accuracy.

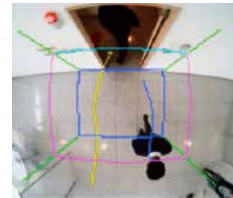

FEATURES

- Door cancel function
Ignore door movement on installation side of detection unit.
- Workability
Install on existing door
- Detection area adjustability
Detection area can be adjusted after installation of detection unit.
- Sensitivity adjustability
Sensitivity can be adjusted after installation

SPECIFICATIONS

Items	Specifications		Remarks
Detection Method	Vector Focusing Method		
Detection Accuracy	> 95% (by own criteria)		
Supply Voltage	Power over Ethernet IEEE 802.3 af		
Warm-up time	Approx. 45 sec.		
Power Consumption	Control box	10 W max.	
	Detection unit	10 W max.	
Indicator	Control box	Green	Power, Authorization, Normal entry (lit)
		Red	Tailgating (lit) / Multiple detections (blinking)
	Detection unit	Green / Red	Warm-up (lit) / Trouble (blinking)
		Green	Communication trouble (alternative blinking)
		Red	Power (lit) / Normal entry (blinking)
		Orange	Tailgating (lit) / Multiple detections (blinking)
Dimensions	Control box	265 × 135 × 31 mm	(W × H × D)
	Detection unit	193 × 85 × 34 mm	(W × H × D)
Weight	Control box	800 g	
	Detection unit	220 g	
Operating Temperature	0 to 50°C		
Operating Humidity only under no condensation	< 80% RH		only under no condensation
Operating Illuminance only the outline of an object is shown	100 to 20,000 lux *1		only the outline of an object is shown
Applicable Door Type	Manual Swing Door/Automatic Slide Door		
Installation location	Control box	Wall / stationary	Indoor
	Detection unit	Ceiling	Indoor
Mounting Height	Detection unit	2.5 to 4.0 m *2	It may be limited by environmental conditions.
LAN wiring	CAT5e or larger		100 m max. in length
Ethernet	100Base-T(X)		Protocol: TCP/UDP(IPv4), ARP, ICMP or HTTP
Input terminal *3	Authorization	N.O./N.C. no voltage Wiegand	26/37bit
	Door open		Use supplied magnet switch when disable to get
	Door locked		
	Disable output *4	N.O./N.C. no voltage	le Tailgating ^{①,②} and Multiple detections
Output terminal *3	Output reset		Stop the output of Tailgating ① and ②
	Tailgating ^①		Variable timer 0.2 to infinity
	Tailgating ^②		Pulse output for every entry
	Normal entry		One shot/Timer switching
	Number of pass	MOS FET relay	Pulse output for authorization
	Unlock command	N.O./N.C. no voltage	Pulse output for authorization
	Authorization number	30 V DC 0.2 A or less	Pulse output for authorization
	Multiple detections	(Resistibility load)	Continuous output during multiple detections *5
Error		Output when disable to detect	

*1 OV-102 always requires 100 lux or more.

*2 Maximum width of door opening is 2 m when mounting at 2.5 m high.

*3 Input/output relays can be selected N.O./N.C. by the dipswitch.

*4 "Disable output" is recommended to use for an entrance with carriage or luggage. They may make a false detection.

*5 Multiple detections must be ON by the dipswitch settings.

Specifications and design are subject to change without prior notice.

A3001S [Detection unit] / A3001CB [Control box]

ANTI-TAILGATING SYSTEM



Accurance 3D is Anti-Tailgate & Anti-Piggyback sensor system that utilizes Time-of-Flight technology for high security two-door interlocks. It adds a layer of security to the access control system by ensuring single occupancy inside the interlock.



FEATURES

- Analyses the X, Y, Z coordinates for all encountered objects in the detection area
- Topographic 3D data guarantees high accuracy rates
- Multiple or suspicious occupancies will not be granted access.
- Does not rely on any heat or light source
- Not affected by reflection or glare
- One control box can manage up to two sensors
- Can be integrated to an access control system via relay outputs
- Can be used in both directions — one way (entry only) & two way (entry & exit)

Piggybacking and tailgating detection with Accurance 3D: sequence of events explained

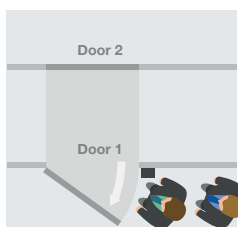

Authorised user presents his/her card and door 1 opens. A second individual follows the first one without swiping his/her card.

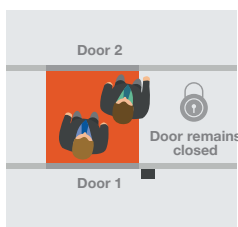

Door 1 shuts and Accurance 3D starts analysing the area inside the interlock. More than one person is detected and access is denied.

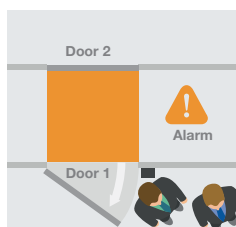

Door 1 re-opens for the occupants to leave the interlock. The interlock is empty, the system can reset.

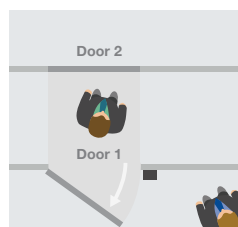

Authorised user presents his/her card and door 1 opens.

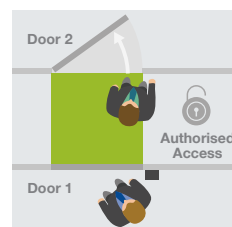

Accurance 3D detects a single occupant in the interlock. Access is granted and door 2 opens.

SPECIFICATIONS

Power input	24VDC - Supplied from control box
Current draw	840 mA max. (24 VDC)
Operating temperature	-10°C to +50°C
Operating humidity	0% to 80% - No condensation
Installation location	Indoor
Applicable door	Outward opening interlock door
Detection method	Time of Flight
Light source	IR LED
Image pixels	176(H) 132(V)
Angle of view	Horizontal: Approx. 70°, Vertical: Approx. 55°
Mounting height	7.55 to 9.51ft (2.3 to 2.9m)
Maximum detection height of person	6.73ft (2.05m) - Depends on installation height & location
LAN	Ethernet (100BASE-TX) RJ-45
Indicators	Power: green. Output: green, red, blue
Dimensions	6.3 x 2.83 x 1.97in (160 x 72 x 50mm) H x W x D - Excluding cables
Weight	1.32lb (600g) - Excluding cables

Specifications and design are subject to change without prior notice.

R1002S(E) [Detection unit] / R1002CB(E) [Control box]

REVERSE DETECTION SYSTEM

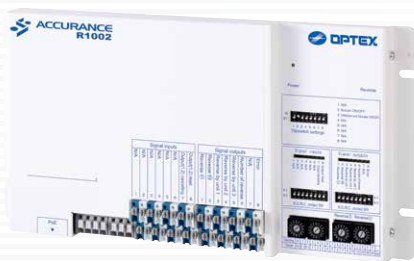

Reverse Detection System R1002 with an unique detection algorithm [Vector Focal Method] is designed to detect backward movement of human(s) in a specific area. The system are suitable for applications to catch a suspicious individual such as airports for an efficient facility management or security.

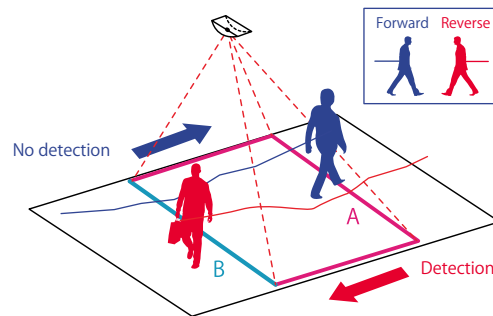

FEATURES

- **Accurate detection**
An unique detection method [Vector Focal Method] grasps and tracks a shape of human sterically.
- **Reverse detection**
Grasp all human movements and detect only backward movement
- **System corporation**
Enable to be connected with an upper layer system by using no-voltage output from the control box.

SPECIFICATIONS

Items	Specifications		Remarks
Detection Method	Vector Focusing Method		
Detection Accuracy	> 95% (by own criteria)		
Supply Voltage	Power over Ethernet IEEE 802.3 af		
Warm-up time	Approx. 45 sec.		
Power Consumption	Control box	10 W max.	
	Detection unit	10 W max.	
Indicator	Control box	Green	Power (lit)
		Red	Reverse detection (lit)
		Green / Red	Warm-up (lit) / Trouble (blinking)
			Communication trouble (alternative blinking)
	Detection unit	Green	Power (lit)
		Red	Reverse detection (lit)
Dimensions	Control box	265 × 135 × 31 mm	(W × H × D)
	Detection unit	193 × 85 × 34 mm	(W × H × D)
	Control box	800 g	
	Detection unit	220 g	
Operating Temperature	0 to 50°C		
Operating Humidity only under no condensation	< 80% RH		only under no condensation
Operating Illuminance only the outline of an object is shown	100 to 20,000 lux *1		only the outline of an object is shown
Installation location	Control box	Wall / stationary	Indoor
	Detection unit	Ceiling	Indoor
Mounting Height	Detection unit	2.5 to 4.0 m	It may be limited by environmental conditions.
LAN wiring	CAT5e or larger		100 m max. in length
Ethernet	100Base-T(X)		Protocol : TCP/UDP(IPv4), ARP, ICMP or HTTP
Input terminal *2	Disable output Disable reverse detection [1] and [2]		
	Output reset Stop the outputs of reverse detection [1] and [2]		
Output terminal *2	Reverse detection [1]	MOS FET relay N.O./N.C. no voltage 30 V DC 0.2 A or less (Resistibility load)	Variable timer 0.2 to infinity
	Reverse detection [2]		
	Unit [1] detects Pulse output for reverse detection by unit [1]		Pulse output for the number of reverse detection by unit [1]
	Unit [2] detects Pulse output for reverse detection by unit [2]		Pulse output for the number of reverse detection by unit [2]
	Unit [3] detects Pulse output for reverse detection by unit [3]		Pulse output for the number of reverse detection by unit [3]
	Number of reverse detections		Pulse output for the number of reverse detection
Error	Output when disable to detect		

*1 R1002 always requires 100 lux or more.

*2 Input/output relays can be selected N.O./N.C. by the dipswitch.
Specifications and design are subject to change without prior notice.

By utilizing our unique detection logic and optical technique, OPTEX provides high performance against false and missed alarms.



Sunshine Protection Technology & Double Modulation Beam	74
Automatic Transmit Power Control	74
Quad Beam & United Appearance	75
Lightning & Surge Protection	75
Sniper Viewfinder™	76
Beam Alignment Unit	76
LED Indicator and Sound Assist	76
Beam Power Control Selector	77
Maximum Arrival Distance, Maximum Detection Range & Sensitivity Tolerance	77
Adjustable Beam Interruption Time	78
Against Environmental Changes	78
Battery Operated Technology	79
Advanced Temperature Compensation	80
Summer Night Compensation Logic	80
Double-Layered Detection Patterns	81
Intelligent AND detection Logic	81
Digital Quad Zone Logic & Multi-Focus Optics	82
Spherical Fresnel Lens Design	83
Double Conductive Shielding	84
Digital Anti-Masking Technology	84
Sealed Optics	85
Microwave Area Shaping Technology	85
IP (International Protection) Code	86

Sunshine Protection Technology & Double Modulation Beam

A-ZONE

Appropriate models

SL-200QDM/350QDM/650QDM, SL-200QDP/350QDP/650QDP

Sunshine Protection Technology

The sunshine protection technology has a triple layer construction to give better performance against external light sources (e.g. the sun, mercury-vapor lamps, and fluorescent lights).

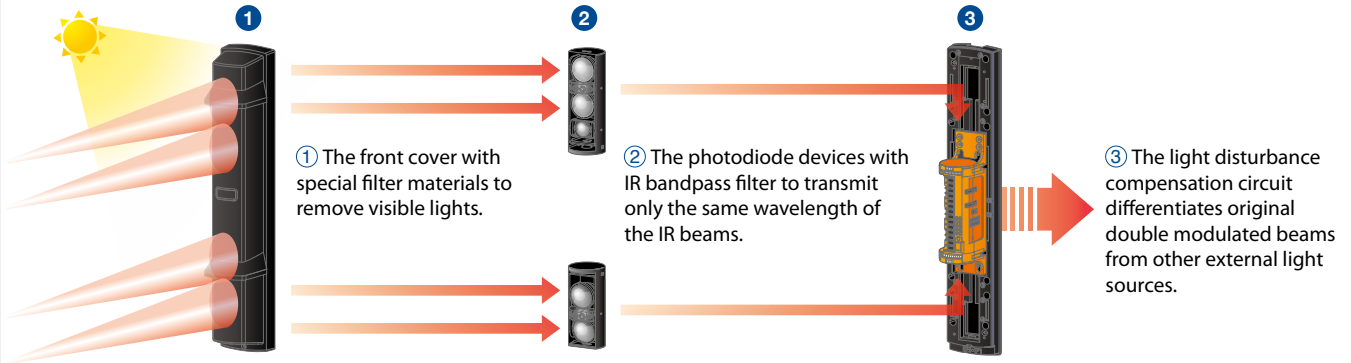

Double Modulation Beam

The SL-QDM and SL-QDP offer double modulation beams that differ in pulse patterns. This can enhance signal discrimination against potential noise interference such as sunlight or other external light sources, resulting in a reduction of missed alarms. Together with OPTEX triple layered sunshine protection technology, it ensures high reliability under the severe outdoor security environment.

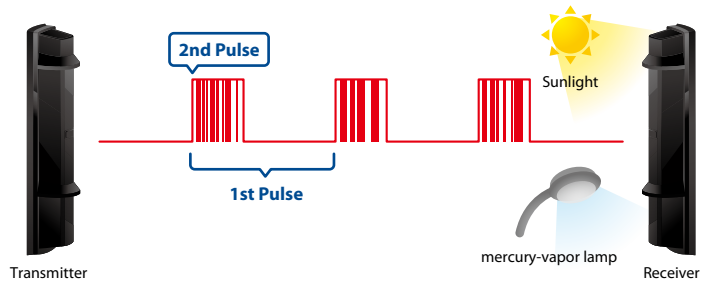

Automatic Transmit Power Control

A-ZONE

Appropriate models

SL-200QDM/350QDM/650QDM

Automatically controls, adjusts and optimizes the power of the beam and maintains optimal performance. It decreases false and missed alarms caused by fog, frost, cross talk, signal saturation.

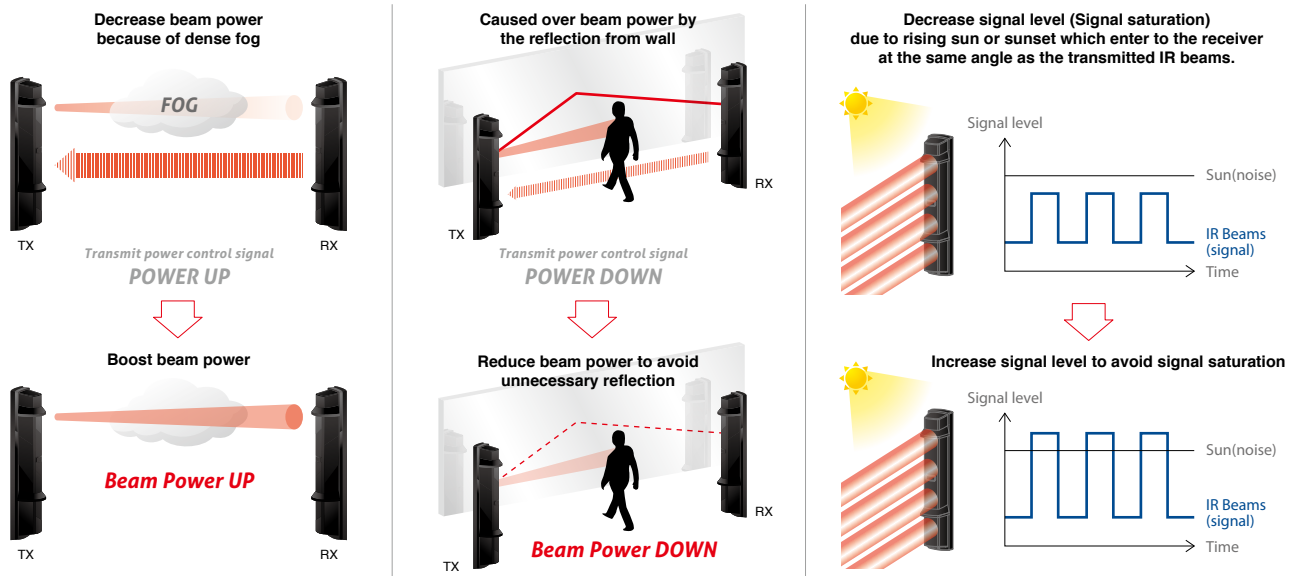

Quad Beam & United Appearance

A-ZONE

Appropriate models

SL-200QDM/350QDM/650QDM, SL-200QDP/350QDP/650QDP, SL-200QN/350QN/650QN, SL-350QFR/350QNR

By employing quad beam, it dramatically reduces false alarm caused by birds and falling leaves. Moreover, it is also important that the housing design of both long and short beams are united. 60m (200ft.) range models, SL-200QN/SL-200QDP/SL-200QDM with a wide beam pitch is now available.

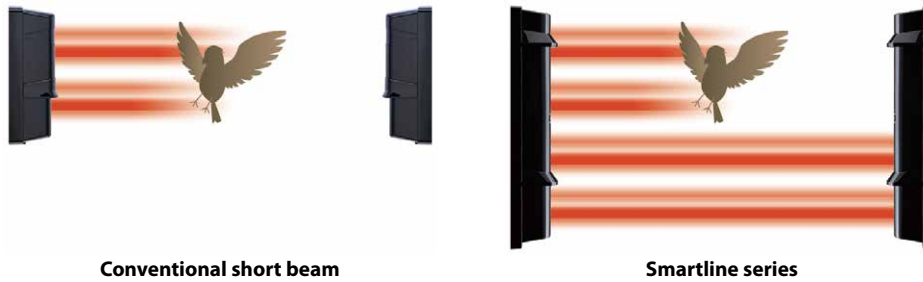

Conventional short beam

Smartline series

Lightning & Surge Protection

A-ZONE

Appropriate models

SL-200QDM/350QDM/650QDM, SL-200QDP/350QDP/650QDP, SL-200QN/350QN/650QN, AX-70TN/130TN/200TN, AX-100TF/200TF

Lightning surges are a constant source of problems for electronic equipment that is used outdoors.

There are two types of lightning surge: 1) direct strike and 2) induced surge.

In a direct lightning strike, the amount of energy dissipated is so great that there is currently no means of protecting electrical equipment from damage. A lightning induced surge may be caused by the movement of charged clouds or a nearby lightning strike. Either of these causes can induced surge voltages in electrical wiring. It is possible to provide some degree of protection against lightning induced surges by installing surge absorbers at appropriate locations as shown in the diagram.

Our Smartline series and AX series can withstand a lightning surge up to 14kV without damage resulting in faulty operation (IEC801-5 lightning surge noise is the maximum level of our test).

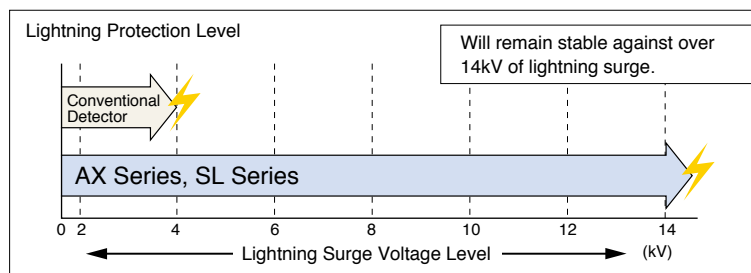

Sniper Viewfinder

A-ZONE

Appropriate models

SL-200QDM/350QDM/650QDM, SL-200QDP/350QDP/650QDP, SL-200QN/350QN/650QN, SL-350QFR/350QNR

X2 MAGNIFICATION LENS

The new telescope lens has a high level of visibility for optical alignment work. Even over long distances, a perfect installation and stable performance can be achieved in a short period.



Conventional model



X2 magnification lens

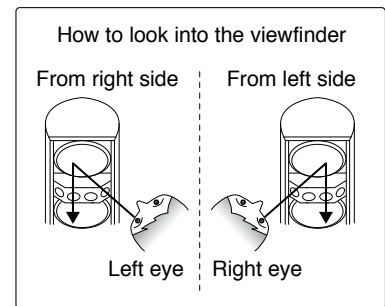
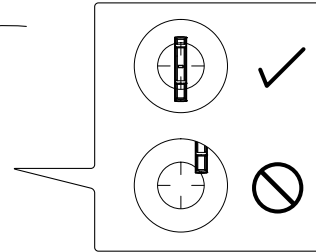
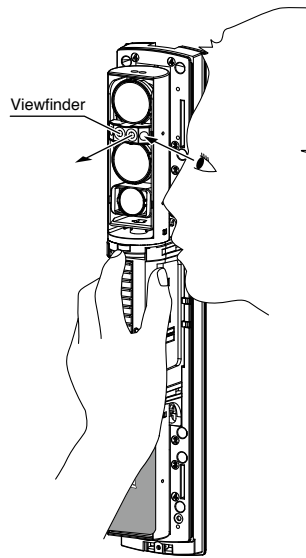

Beam Alignment Unit : BAU-4 (Option)

A-ZONE

Appropriate models

SL-200QDM/350QDM/650QDM, SL-200QDP/350QDP/650QDP, SL-200QN/350QN/650QN, SL-350QFR/350QNR

The BAU-4 beam alignment unit automatically and accurately adjust the optical axis. This allows peak performance and gives one technician the ability to install the 200 m (650 ft.) Smartline detector by himself.

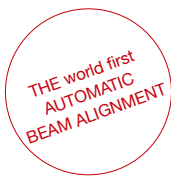

LED Indicator and Sound Assist

A-ZONE

Appropriate models

SL-200QDM/350QDM/650QDM, SL-200QDP/350QDP/650QDP

The alignment level indicators have 5 LEDs, each LED represents the level of alignment, ranging from poor to excellent. The optical alignment level can also be checked by sound.



TRANSMITTER



RECEIVER

Beam Power Control Selector

A-ZONE

Appropriate models SL-200QDM/350QDM/650QDM, SL-200QDP/350QDP/650QDP

The beam power control selector allows you to manually adjust beam power from NORMAL to LOW or VERY LOW. This function is effective for the following purposes:

- For countermeasure against crosstalk due to reflection of wall or floor by reducing beam power.
- For countermeasure against interference due to unstable S/N (signal / noise) ratio when using multiple photo beams for long distance or beam stacking applications.
- To reduce beam power when using the detector for a distance shorter than the rated distance.
- To search the peak value when making optical alignment to support perfect alignment.

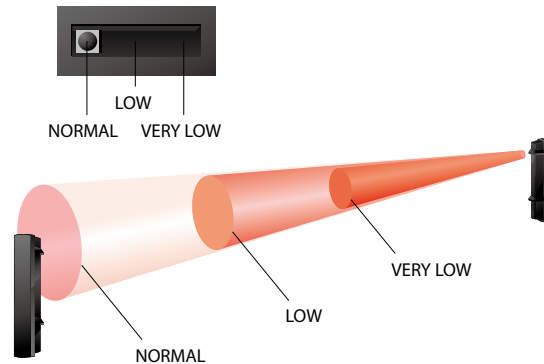

Maximum Arrival Distance, Maximum Detection Range & Sensitivity Tolerance

A-ZONE

Appropriate models SL-200QDM/350QDM/650QDM, SL-200QDP/350QDP/650QDP, SL-200QN/350QN/650QN, SL-350QFR/350QNR, AX-100TFR/200TFR, AX-100TF/200TF, AX-70TN/130TN/200TN, BX-100PLUS

— Maximum Arrival Distance & Maximum Detection range

Maximum arrival distance means theoretical distance which the beam arrives without counting external factor as a product specification. Maximum detection range is rating distance of detection range in use.

— Sensitivity Tolerance

Sensitivity tolerance can be calculated from maximum arrival distance and detection range. Distance tolerance is a distance allowance value against the reduction of the beam by external factor.

$$\text{Distance tolerance} = (\text{Maximum arrival distance} / \text{Detection range})$$

$$\text{Sensitivity tolerance} = (\text{Distance tolerance})^2$$

e.g.) In case of using SL-350QFR at the distance of 100m
 (Maximum arrival distance: 1000m)
 Distance Tolerance = 10 times
 Sensitivity Tolerance = 100 times

A certain amount of sensitivity tolerance is required for the stable operations of outdoor photoelectric detectors without false alarms, because the beam power is reduced under severe outdoor environments, e.g. dense fog, rain, snow or dust storms. The following figure is the general indications. All Optex outdoor photoelectric detectors have sensitivity tolerance of 100 times at a rating distance.



Dense fog



Rain



Snow

General recommended indication

Type of photoelectric detector	Sensitivity tolerance
Indoor photoelectric detector	4 to 25 times
Outdoor photoelectric detector (up to 50 m)	25 to 100 times
Outdoor photoelectric detector (upward of 50 m)	More than 100 times

OUTDOOR PROTECTION

INDOOR PROTECTION

REDWALL

ACCESS CONTROL

TECHNICAL INFORMATION

Adjustable Beam Interruption Time

A-ZONE

Appropriate models

SL-200QDM/350QDM/650QDM, SL-200QDP/350QDP/650QDP, SL-200QN/350QN/650QN, SL-350QFR/350QNR, AX-100TFR/200TFR, AX-100TFR/200TFR, AX-70TN/130TN/200TN, AX-100TF/200TF

By using the beam interruption time potentiometer, it is possible to increase the time the beam must be broken in order to generate an alarm. This will reduce the chance of false alarms being caused by falling leaves, blowing debris or animal or bird movement within the protected area. Refer to the diagram before making any adjustments. If you make the beam Interruption time too long, quickly moving intruders may be able to pass through the beams undetected. After performing this adjustment be certain to do a walk-thru test and confirm that the detector will provide a satisfactory level of protection.

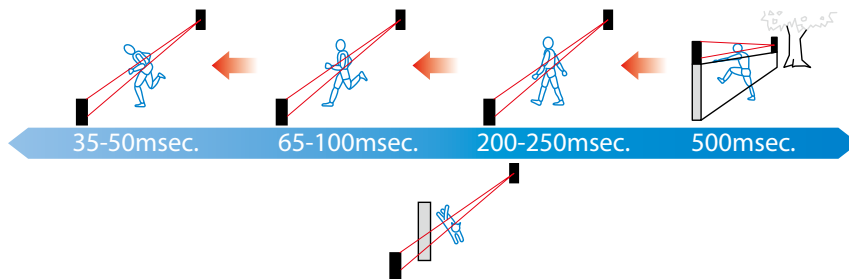

Against Environmental Changes

A-ZONE

Appropriate models

[A.G.C.Circuit] AX-100TFR/200TFR, AX-70TN/130TN/200TN, AX-100TF/200TF, BX-100PLUS
[D.Q.Output] SL-200QDM/350QDM/650QDM, SL-200QDP/350QDP/650QDP, SL-350QFR/350QNR, AX-100TFR/200TFR, AX-100TF/200TF

A.G.C. (Automatic Gain Control) circuit

The A.G.C. circuit continually monitors for gradual changes in the signal's strength caused by changing weather conditions. It gains the sensitivity accordingly to maintain weather conditions.

D.Q. output (environmental disqualification)

D.Q. output will send a trouble signal when the beam strength is below acceptable levels, for more than 20-40 seconds, due to rain, snow, or heavy rain.

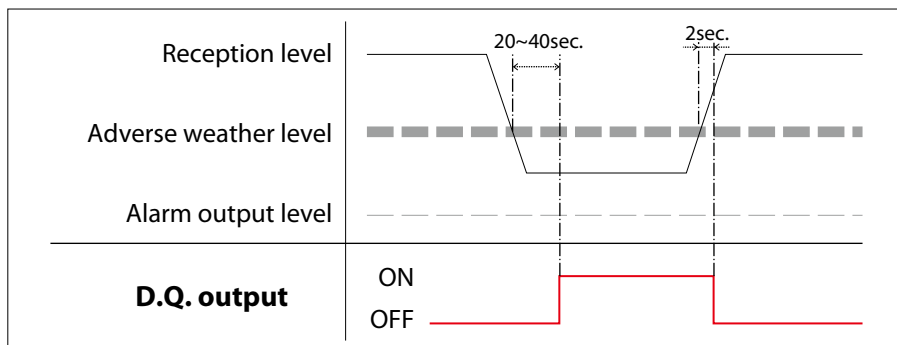

Battery Operated Technology

A-ZONE

B-ZONE

Appropriate models

SL-100TNR/200TNR, SL-350QFR/350QNR, FTN-R/RAM, AX-100TFR/AX-200TFR, HX-80NRAM, HX-40RAM, VXI-R/RAM/RDAM, BX-80NR

Back box for wireless transmitters and batteries

Appropriate models | SL-350QFR/350QNR, FTN-R/RAM, AX-100TFR/AX-200TFR, HX-80NRAM, HX-40RAM, VXI-R/RAM/RDAM, BX-80NR

Back box can conceal wireless transmitter. Especially, AX-100/200TFR allows you to easily replace the batteries without opening the front cover. Not necessary to do the optical alignment.

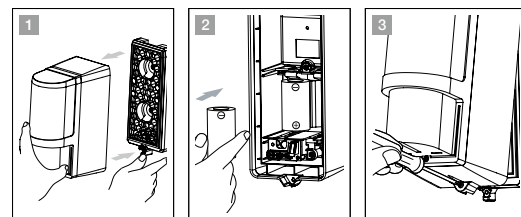
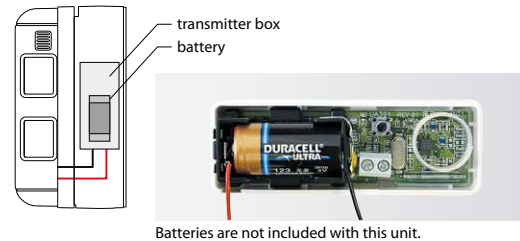

Intermittent output function

Appropriate models | SL-100TNR/200TNR, SL-350QFR/350QNR, AX-100TFR/200TFR

Alarm signals are sent periodically to avoid missed alarm while the beam is broken. Its function is effective for wireless systems which do not recognize "Restore" status.

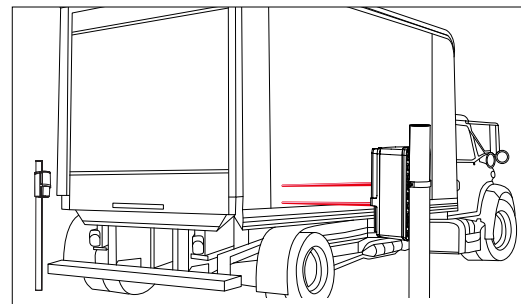

Battery saving timer function

Appropriate models | SL-100TNR/200TNR, SL-350QFR/350QNR, AX-100TFR/200TFR, HX-40RAM, VXI-R/RAM/RDAM, HX-80NRAM, BX-80NR

Alarm output activation are limited by a timer to 5 to 120 seconds. Even if there are continuous alarm events, the alarm output operates only once in the timer period. It prolongs the battery life of a wireless transmitter

Low Battery Output and LED

Appropriate models | SL-100TNR/200TNR, SL-350QFR/350QNR, AX-100/200TFR, HX-40RAM, HX-80NRAM

When the battery capacity becomes low, the unit automatically outputs fixed time transmission to call attention. When low battery signal is output, Anti-masking function will be canceled in order to extend the battery life. When low battery signals is output, replace all the batteries with new ones.



Advanced Temperature Compensation

B-ZONE

Appropriate models

HX-80N/80NAM/80NRAM, HX-40/40AM/40DAM/40RAM, BX-80N/80NR, VXI-ST/AM/DAM/R/RAM/RDAM

At a higher ambient temperature, the temperature difference between the background and a human body will be reduced. In this case the PIR could fail to readily detect a human body. With conventional temperature compensation functions, the sensitivity of detector must be set higher at 35°C than the sensitivity at 25°C (normal temperature) in order for the detector to offer a stable performance. However, with this setting, the sensitivity of the detector is excessively high at 40°C or over, which could lead to various problems. To overcome this drawback, Optex's advanced temperature compensation function allows the detector's sensitivity to automatically drop at 40°C or higher so that the detector can perform more reliably within a wider ambient temperature range.

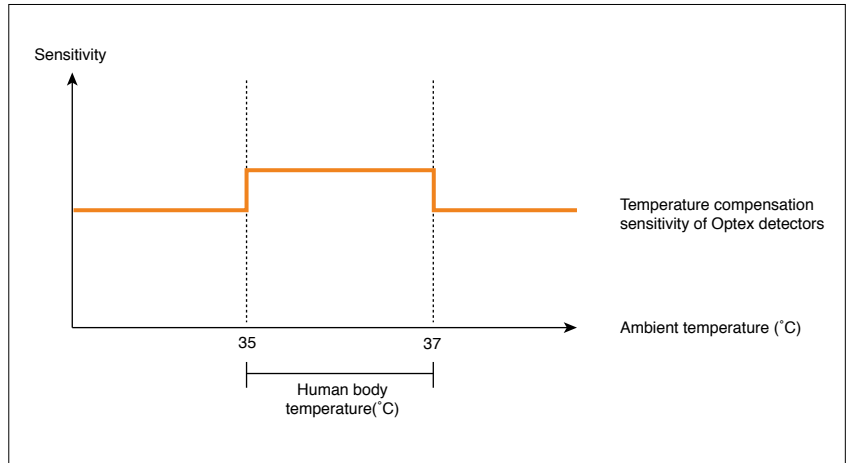

Summer Night Compensation Logic

B-ZONE

Appropriate models

HX-80N/80NAM/80NRAM, HX-40/40AM/40DAM/40RAM

During summer evenings and nights, areas which are in shade can create an environment where the difference between human body and the surrounding ambient temperature can be at its lowest point. This logic addresses this issue by measuring the luminance levels and the changes in the environment.

The integration of temperature and additional luminance analysis provides the product the ability to more accurately assess true environmental conditions and sharpens the sensitivity as the environmental conditions require. This combination greatly reduces the potential for missed alarms, while maintaining stability.

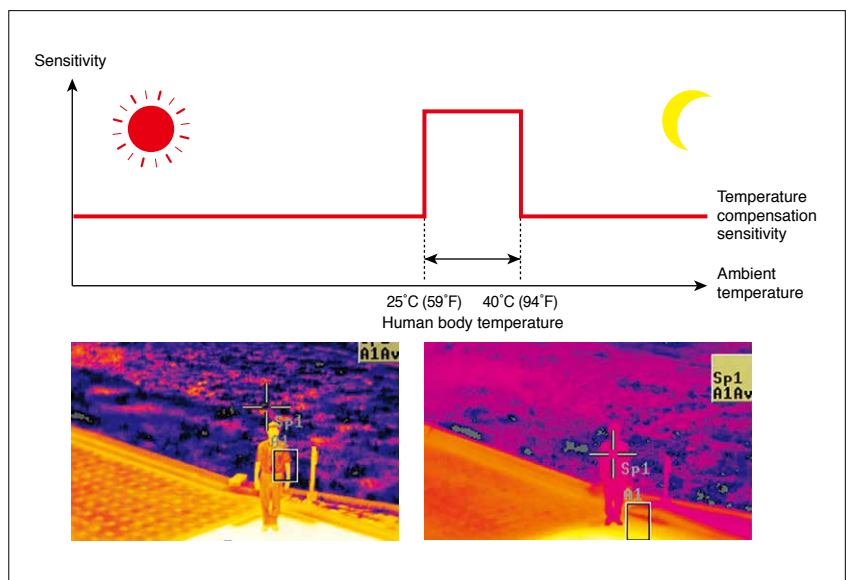

Double-Layered Detection Patterns

B-ZONE

Appropriate models

FTN-ST/AM/R/RAM, BX-80N/80NR, VXI-ST/AM/DAM/R/RAM/RDAM, WXS-AM/DAM/RAM/RDAM, WXI-ST/AM/R

OPEX's outdoor PIR detectors utilize the multiple detection pattern technology, two double-layered detection patterns (upper and lower) both have to be activated to generate an alarm condition. This reduces false alarms, particularly those caused by temperature changes, light reflection and small animals.

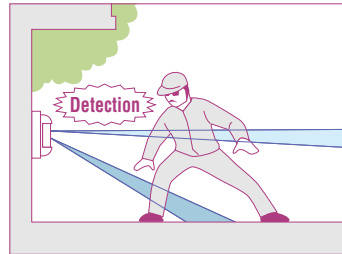

Multiple Detection Pattern of VXI-ST/AM/DAM/R/RAM/RDAM



Multiple Detection Pattern of BX-80N/80NR

— Size Judging function

The size judging function virtually eliminates false alarms due to small animals and other moving objects like car.

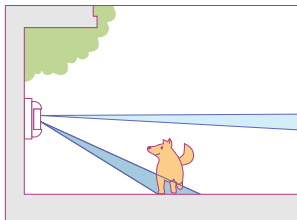

When only the lower zone detects a moving object, the unit is not activated.

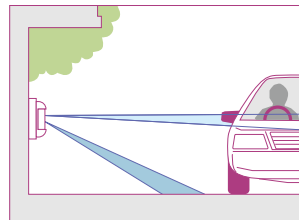

When only the upper zone detects a moving object, the unit is not activated.

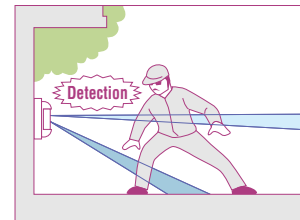

When both the upper & lower zones detect a moving object, the unit is activated.

Intelligent AND detection Logic

B-ZONE

Appropriate models

HX-80N/80NAM/80NRAM, HX-40/40AM/40RAM/40DAM

By utilizing originally developed pyro-elements, it creates a configuration area consisting of 94 high density detection zones. Also the AND detection pattern technology requires both detection areas have to be activated in order to generate an alarm condition making it more tolerant to false alarms caused by small animals or pets.

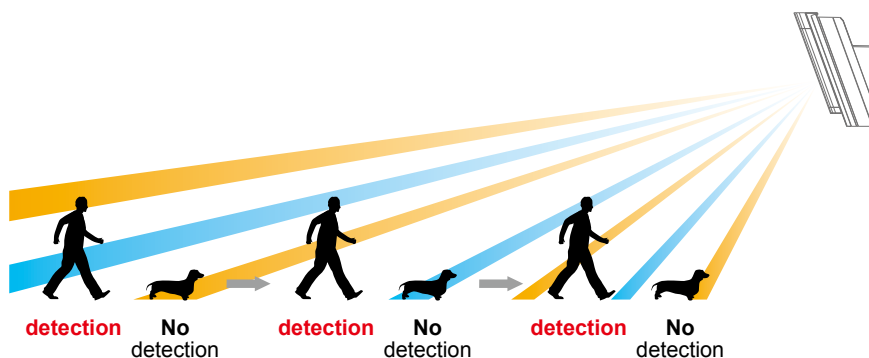

Digital Quad Zone Logic & Multi-Focus Optics

C-ZONE

Appropriate models

[Multi-Focus Optics] CX-702/702RS, SX-360Z

OPTEX has 2 different detection logics, digital quad zone logic and multi-focus optics. Each logic creates high vertical density detection zones by original optical technology to prevent false alarms.

High Vertical Density Detection Zones of Quad Zone Logic and Multi-Focus Optics

Normally, a detector uses twin elements create two detection zones but Optex's detectors create an extremely high vertical zone density, two or three times the size of that in conventional PIRs. These taller zones capture the entire body mass of a person and enable detection of the smallest temperature contrast between them and the background.

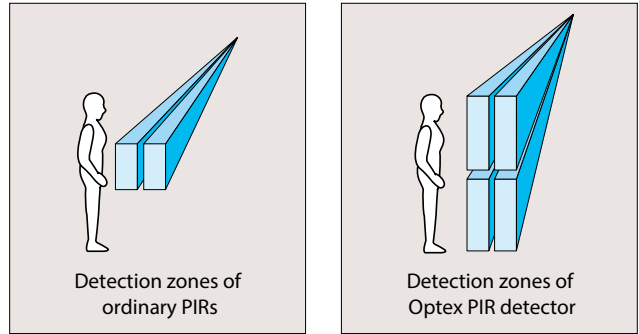

Detection Logics

— Multi-Focus Optics

If a person is hidden from the PIR detector, he or she is not detected. In ordinary residences and offices, there are desks, shelves and other furniture. When these objects hide a part of the body, it may make detection difficult.

Multi-focus optics provides taller detection areas, which can be raised 1.5 to 2.0 times than ordinary optics and improve the detection ability to eliminate most dead spots regardless of the presence of furniture or other obstacles.

Ordinary optics

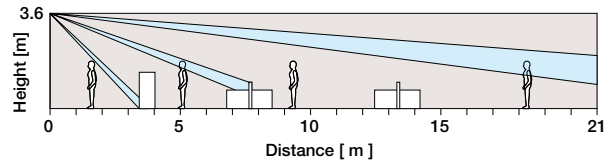

Optex optics

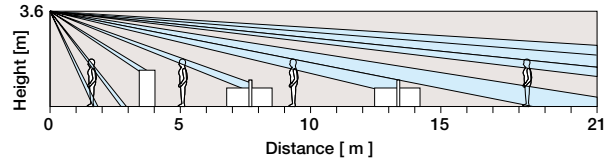

— Digital Quad Zone Logic

OPTEX's indoor detectors have from 78 to 82 zones to cover the hole detection area. At any spot within the detection area more than 4(quad) zones are utilized to verify if it should generate alarm or not. Also the CORE platform enables the quad zone logic to evolve to the next step. Providing digital quantification of infrared energy. digital quad zone logic enhanced accuracy in both human detectability and pet immunity.

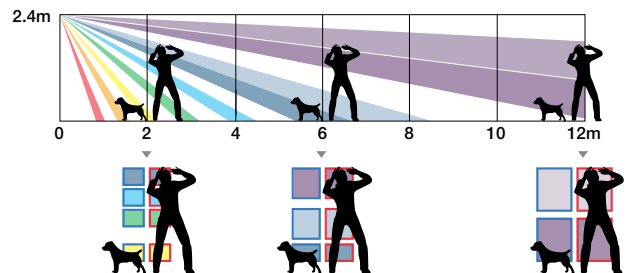

Spherical Fresnel Lens Design

C-ZONE

Appropriate models

FLX-S-ST/DT,FLX-P-ST/DT,FLX-A-AM/DAM, CX-702/702RS, SX-360Z

Spherical lens provides a precise focal length to each of the multiple lens segments (uniform distance between each lens segment and the pyroelectric elements). This enables each lens segment to face precisely towards its detection area, and creates detection zones without distortion, achieving a new level in lens design precision.

Conventional flat lens

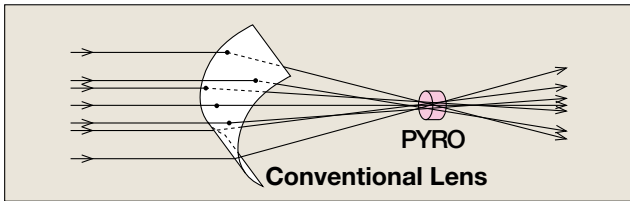

Optex spherical lens

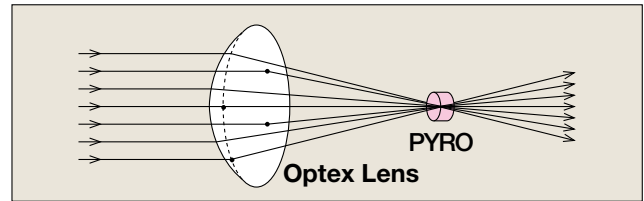

Conventional flat lenses inevitably create sensitivity distortion problems when they are bent to fit a curved housing. Optex's spherically designed lens will obtain sharp detection because no bending is required.

The spherical fresnel lens differs from the conventional flat fresnel lens in that the distance between the lens and the pyro-electric elements is the same across the entire lens (the focal length is always the same). It therefore collects infrared rays more efficiently.

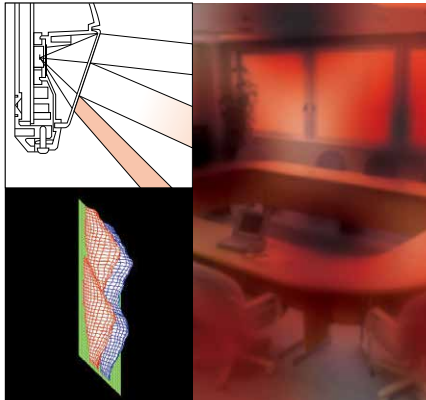

Each focused image (detection zone) has poorly defined borders (=Inaccurate sensitivity) and does not produce sufficient contrast against the background (=low detection performance). Because the IR energy is poorly focused, objects entering these low contrast border areas produce weak, poorly defined electrical signals within the detector.

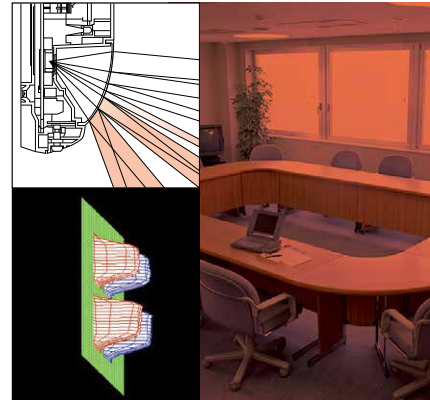

Each focused image (detection zone) has sharply defined edges (=accurate sensitivity) and it produces the maximum signal contrast against the background area (=high detection performance). This sharp focus provides the maximum signal power to the detector, compared to a weak, sluggish signal created by a poorly focused zone.

Double Conductive Shielding

B-ZONE

C-ZONE

Appropriate models

VXS-AM/DAM/RAM/RDAM, VXI-ST/AM/DAM, VXI-R/RAM/RDAM, HX-80N/NAM/NRAM, HX-40/AM/RAM/DAM, BXS-ST/AM/R/RAM, BX-80N/NR, LX-402/802N, WXS-AM/DAM/RAM/RDAM, WXI-ST/AM/R, FLX-P-ST/DT, FLX-A-AM/DAM, CX-702/702RS, SX-360Z

By using our double conductive shielding, the visible light disturbance and RFI can be blocked.

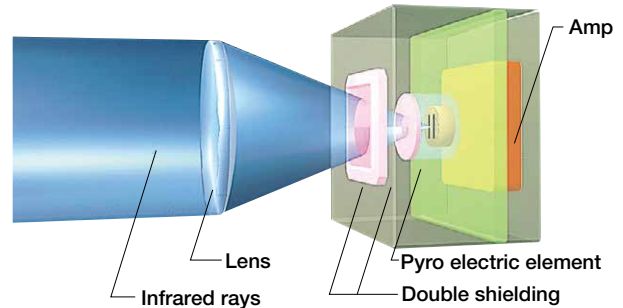

Visible Light Protection

Visible light disturbance protection will prevent a false alarm when a 60W halogen lamp is turned on close to the detector. No false alarm is triggered even when a car flashes its headlights at the detector at a distance of 30cm (If a car passes through the detector range, of course, the exhaust heat of the car will trigger the alarm).

Also no false alarm will be triggered by sunlight up to an illumination of 100,000 lux. False alarms are most likely caused when early morning or evening sunlight pours into the room, and enters the field of view of the PIR either directly or by reflection. In such a case, however, the illumination reaches only about 50,000 lux. This prevents false alarm, due to double conductive shielding.

RFI Protection

RFI protection has been improved to 20V/m and 30V/m or more by utilizing the double conductive shielding. A field strength of 20V/m means that even if a 10W transmitter is placed within 1 meter of the detector and interference is produced, it will not cause false alarm. With a field strength of 30V/m, a 10W transmitter can be placed within 30-35cm of the detector and not cause a false alarm.

Digital Anti-Masking Technology

B-ZONE

C-ZONE

Appropriate models

HX-40AM/40RAM/40DAM, HX-80AM/80NAM/80NRAM, VXI-AM/DAM/RAM/RDAM, WXS-AM/DAM/RAM/RDAM, WXI-ST/AM/R, FLX-A-AM/DAM

Digital processing circuit guarantees reliability in a practical way by adapting to any changes detected in the environment.

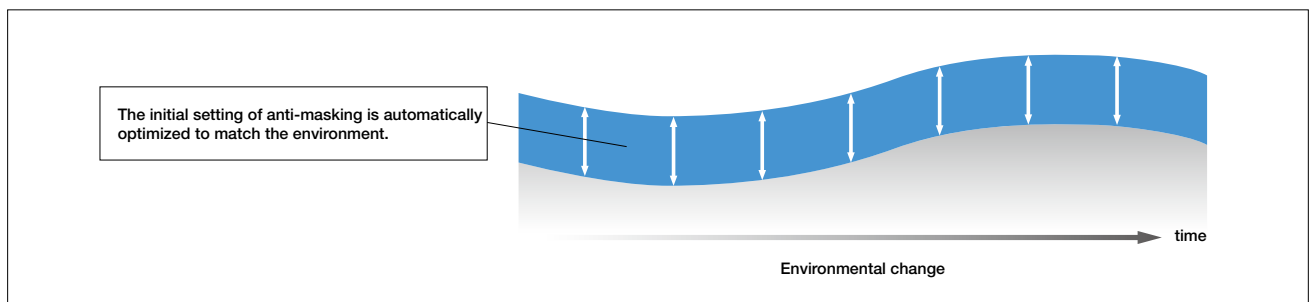

Sealed Optics

C-ZONE

Appropriate models [Sealed Optics] CX-702/702RS
[Advanced Sealed Optics] FLX-S-ST/DT,FLX-P-ST/DT,FLX-A-AM/DAM

The pyroelectric element's field of view is fully enclosed by the sealed optics mechanism of the lens, cover and the sealed optics foam. This mechanism prevents insects from crossing in front of the pyroelectric element. The sealed optics also protect against draft through wiring holes. Easy knockouts reduce extra space between holes and cables, further enhancing the sealing of the entire housing.

Sealed Optics

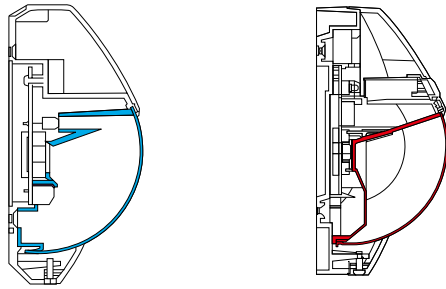

Conventional Structure OTEX Sealed Optics Structure

Advanced Sealed Optics

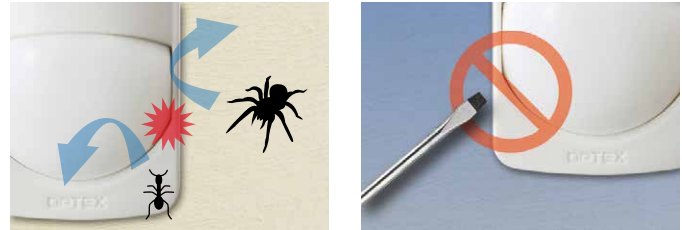

Anti-insect design

Pick-proof design

Microwave Area Shaping Technology

C-ZONE

Appropriate models FLX-S-DT,FLX-P-DT,FLX-A-DAM

When microwave and PIR detection are used together, the detection areas of each must be the same in order to make accurate detection. But traditionally this can be a problem because...

- Firstly, microwaves are not always limited by objects such as wall, windows and partitions, whereas PIR detection is.
- Secondly, the distances at which microwaves can detect movement tend to be far greater than those required by internal intruder detection applications.

Microwave area shaping technology overcomes these problems by matching the microwave detection area to that of the PIR and by limiting it to the room being covered. Long or short distance can be set roughly, by selecting the range using the switch and more precise adjustment is obtained. By doing this, false alarms from beyond the required coverage area or outside the room in question are avoided.

Since the detection area has uniform sensitivity, which minimizes false activation's caused by spot movement in the detection area e.g. small animals.

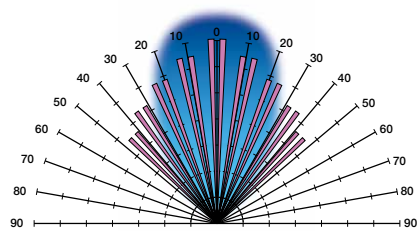

Detection area shape of PIR and microwave are not the same

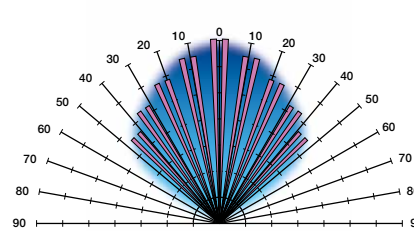

Ideal detection area of Optex combination detector

IP (International Protection) Code

A-ZONE

B-ZONE

Optex uses parts that meet various requirements of international standards in order to meet strict rules for putting safety markings on our products. These standards often require that devices meet or surpass certain ratings specified by **IP (International Protection)** code.

IP tests have been done based on the standard, IEC529 which is required for our all products. IP codes are often required even for parts or partially assembled products.

Following is a brief explanation on the meaning of each number of the IP code.

Arrangement of the IP code

IP65

Degree of protection against solid object

- 0** Non-protected
- 1** Solid object such as human fist (diameter of 50mm or more) shall not penetrate into product.
- 2** Solid object such as human fingers (diameter of 12.5mm) shall not penetrate into product.
- 3** Solid object such as tool (diameter of more than 2.5mm) shall not penetrate into product.
- 4** Solid object such as wire (diameter of more than 1.0mm) shall not penetrate into product.
- 5** Ingress of dust shall not deteriorate performance and safety of product.
- 6** Dust-tight, No ingress of dust

Degree of protection against water

- 0** Non-protected
- 1** Vertically falling water drops shall have no harmful effect on installed product.
- 2** Vertically dripping water on installed product that is tilted up to an angle of 15° shall have no harmful effect.
- 3** Sprayed water to installed product at any angle up to 60° from the vertical shall have no harmful effect.
- 4** Water splashing against the enclosure from any direction shall have no harmful effect.
- 5** Water protected by a nozzle against enclosure from any direction shall have no harmful effect.
- 6** Water protected in powerful jets against enclosure from any direction shall have no harmful effect.
- 7** Water protected. Protected against the effect of temporary immersion in water.
- 8** Waterproof. Protected against the effect of continuous immersion in water.

OPTEX Company Introduction

The Japanese manufacturer Optex was founded in 1979 and is now becoming a world-leading company in the area of security detectors with its unique infrared detection technology.

In addition to providing highly reliable detectors developed with our unique technology, Optex also upholds environmental policies that strive to make eco-friendly products through the entire process from design and development. In 1997, Optex was certified for complying with ISO 14001 international environmental management standards amid the growing interest in environmental protection on the global level.

Product procurement in over 80 countries worldwide led Optex to implement strategies for achieving global standards for quality at an early stage. The company has also received certification for ISO 9001 and ISO27001.

As a pioneer in infrared technology, Optex will continue to meet the needs of customers worldwide by further striving to advance quality control with precision and efficiency along with building systems for global-standard quality.

CONCEPT FOR LEVEL SURVEILLANCE

KEY POINT TO ACHIEVE ADVANCED SECURITY..... P05

A-ZONE | PERIMETER OUTDOOR DETECTORS

SL-200QDM/350QDM/650QDM	P06
SL-200QDP/350QDP/650QDP	P07
SL-200QN/350QN/650QN	P08
SL-100TNR/200TNR	P09
SL-350QFR/350QNR	P10
AX-100TFR/200TFR	P11
AX-100TF/200TF	P12
AX-70TN/130TN/200TN	P13
OPTIONS	P14
PRODUCT SPECIFICATIONS	P16

B-ZONE | MIDDLE AREA DETECTORS

WXS-AM/DAM	P18
WXS-RAM/RDAM	P19
WXI-ST/AM	P20
WXI-R/RAM	P21
VXS-AM/DAM	P22
VXS-RAM/RDAM	P23
VXI-ST/AM/DAM	P24
VXI-R/RAM/RDAM	P25
BXS-ST/AM	P26
BXS-R/RAM	P27
BX-80N	P28
BX-80NR	P29
FTN-ST/AM	P30
FTN-R/RAM/R-PT/RAM-PT	P31
HX-80N/NAM	P32
HX-80NRAM	P33
HX-40/AM/DAM	P34
HX-40RAM	P35
QXI-ST/DT	P36
QXI-R/RDT	P37
LX-402/802N	P38
BX-100PLUS	P39
OPTIONS	P40
PRODUCT SPECIFICATIONS	P42

C-ZONE | INDOOR DETECTORS

FLX-A-AM/DAM	P46
FLX-P-ST/DT	P47
FLZ-S-ST/DT	P48
CX-702/702MKII	P49
CX-702RS	P50
SX-360Z	P51
FX-360	P52

AP-360B/360BR	P53
AP-20NB/20NBR	P54
OPTIONS	P55
PRODUCT SPECIFICATIONS	P56

REDWALL/REDFSCAN

SIP-3020/4010/404	P58
SIP-3020WF/4010WF/404WF.....	P59
SIP-3020/5 SIP-4010/5 SIP-404/5	P60
SIP-5030/100	P61
RLS-20100V/3060V	P62
RLS-2020V/A	P63
RLS-3060L/SH	P64
RLS-2020I/S	P65
PIE-1	P66
OPTIONS	P67
PRODUCT SPECIFICATIONS	P68

ACCESS CONTROL

OV-102	P70
Accurance 3D	P71
R1002	P72

TECHNICAL INFORMATION

Sunshine Protection Technology	
&Double Modulation Beam	P74
Automatic Transmit Power Control	P74
Quad Beam & United appearance	P75
Lightning & Surge Protection	P75
Sniper Viewfinder	P76
Beam Alignment Unit	P76
LED Indicator and Sound Assist	P76
Beam Power Control Selector	P77
Maximum arrival distance, Maximum	
Detection Range & Sensitivity Tolerance	P77
Adjustable Beam Interruption Time	P78
Against Environmental Changes	P78
Battery Operated Technology	P79
Advanced Temperature Compensation	P80
Summer Night Compensation Logic	P80
Double-layered Detection Patterns	P81
Intelligent AND detection Logic	P81
Digital Quad Zone Logic & Multi-Focus Optics	P82
Spherical Fresnel Lens Design	P83
Double Conductive Shielding	P84
Digital Anti-masking Technology	P84
Sealed Optics	P85
Microwave Area Shaping Technology	P85
IP (International Protection) Code	P86

Optex aims to usher in a brighter future with a focus on safety, security, and comfort through the use of sensing technology.

OPTEX Overview

As of January 1, 2020

Company Name	OPTEX CO., LTD.
Official website	www.optex.co.jp/e
Address [Headquarters]	5-8-12, Ogoto Otsu, Shiga, 520-0101 Japan
Representative	President / CEO Toru Kamimura
Capital	350 million yen
Description of business	Development, manufacture, and sales of various sensors, and development of new business areas including IoT
Parent Company	OPTEX GROUP CO., LTD.

Proprietary Technologies for a Wide Range of Business Fields

Using not only various reliable sensing and communication technologies but also solution-based proprietary ideas, Optex helps customers realize the best solutions to improve business activities.

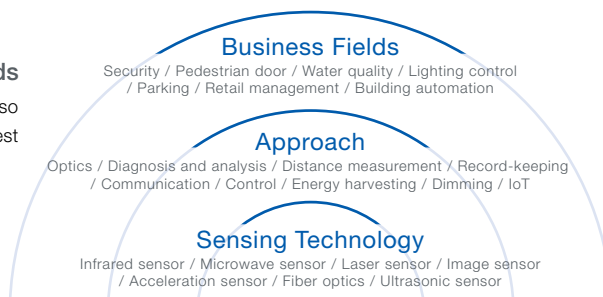

OPTEX Sensing Technologies



Reliable Sensing Technology

Even in environments with numerous factors—including sunlight, small animals, and radio waves—that may interfere with sensor-based detection, Optex utilizes proprietary sensing algorithms to ensure reliable, stable detection.



Application-Based Sensor Equipment Development

Optex introduces sensors capable of accurate detection by incorporating not only knowledge of various sensor features found throughout the globe but also a comprehensive understanding of factors such as detection targets, installation environments, and applications.



Smart Data

Optex sensors work as a type of edge computing device that transmits only the necessary data (smart data), which is created by filtering out unnecessary data from large amounts of sensor data to ensure only the essential data is transmitted.

Global Expansion

Taking advantage of a global network that includes more than 20 bases, Optex provides products and services in 80 countries and regions around the world.



Global Niche Market Leader

Optex is dedicated to meeting the needs of niche markets for special-application sensors and currently boasts the leading share of the global niche market.

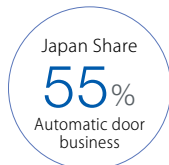
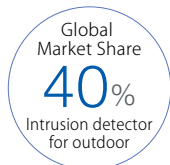

OPTEX CO., LTD. (JAPAN)

www.optex.co.jp/e

OPTEX INC. / AMERICAS HQ (U.S.)
www.optexamerica.com

OPTEX (EUROPE) LTD. / EMEA HQ (U.K.)
www.optex-europe.com

OPTEX SECURITY B.V. (The Netherlands)
www.optex-europe.com/nl

OPTEX SECURITY SAS (France)
www.optex-europe.com/fr

OPTEX SECURITY Sp.z o.o. (Poland)
www.optex-europe.com/pl

OPTEX PINNACLE INDIA, PVT., LTD. (India)
www.optexpinnacle.com

OPTEX KOREA CO., LTD. (Korea)
www.optexkorea.com

OPTEX (DONGGUAN) CO., LTD. SHANGHAI OFFICE (China)
www.optexchina.com

OPTEX (Thailand) CO., LTD. (Thailand)
optex-asean.com