

# ADW 535HDx (ATEX)

## Line type heat detector

Technical description  
As of FW version 01.03.xx



 II 3G Ex ec nC IIC T4 Gc  
II 3D Ex tc IIIC T130°C Dc

---

**Manufacturer:**

Securiton AG  
Alpenstrasse 20  
3052 Zollikofen, Switzerland  
[www.securiton.ch](http://www.securiton.ch)

The product (hardware, software and technical documentation) is subject to the copyright of the manufacturer. Any prohibited modification, misuse, copying or prohibited sale of this product represents a violation of the copyright and will be legally prosecuted.

Copyright by Securiton AG

---

## Validity



### Notice

The names and specifications of the **EN 54-22** product standard contained in this document relate to the draft edition **prEN 54-22**.

This document describes the use of the ADW 535HDx line type heat detector in extreme environmental conditions and its use as operating material in potentially explosive atmospheres of zone 2 and 22 in accordance with VDE 0165 and IEC 60079-10. For use in potentially explosive atmospheres, the **“Use in potentially explosive atmospheres” safety information** must be strictly observed.

This document is valid only for the product described in this chapter and may be changed or withdrawn without prior notice. The validity of the statements made in this document applies until the statements are revised by a new edition of the document (T number with new index). The user of this document is responsible for staying up to date with its current status through the editor/publisher. We accept no responsibility for claims against any incorrect statements in this document that were unknown to the publisher at the time of publication. Handwritten changes and additions are invalid.

Foreign language documents as listed in this document are always released or changed at the same time as the German edition. If there are inconsistencies between the foreign language document and the German document, the German text is binding.

Some words in this document are highlighted in **blue**. These terms and designations are the same in all languages and are not translated. Users are encouraged to contact the editor/publisher if there are statements which are unintelligible, misleading, incorrect or which contain errors.

This document is intended for trained specialists for mounting, installation, commissioning and maintenance of the product.



### Use in potentially explosive atmospheres

- For use in **potentially explosive Ex zones 2 and 22** the information in **ADW 535HDx ATEX Operating Instructions, T 140 459** must always be strictly observed.
- For all work where the ADW 535HDx can be used in potentially explosive atmospheres, the necessary safety measures must be implemented so that the work does not cause an explosion. All work in potentially explosive atmospheres must be approved in writing by the safety manager.

This document is available in the following languages:

German	T 140 458 de
French	T 140 458 fr
English	T 140 458 en
Russian	T 140 458 ru
Swedish	T 140 458 sv

Current edition:            Index d      01.02.2021            Po/Ksa



### Notice

This document is applicable only to the ADW 535HDx line type heat detector with the following production version and firmware version:

<b>Production version</b>	<b>Firmware version</b>
from 010221	from 01.03.xx

The validity of older production versions and firmware versions is guaranteed, with the exception of the new functionalities described in this edition. Additional information about the new functionalities can be found in the document history.

## Validity

### Other documents

Operating instructions ADW 535HDx ATEX	T 140 459	de / en / fr / ru / sv	
Technical description ADW 535 (standard)	T 140 358	de / en / fr / it / es / ru / sv	
Data sheet ADW 535 (standard)	T 140 359	de / en / fr / it / es / ru / sv	
Mounting and installation	T 140 360	de / en / fr / es / ru / sv	
Material for sensing tube	T 140 362	multilingual (ED / FI)	
Commissioning protocol	T 140 363	multilingual (EDFI)	
Data sheets	XLM 35	T 140 088	de / en / fr / it / es / pt / ru / sv
	RIM 36	T 140 364	de / en / fr / it / es / pt / ru / sv
	SIM 35	T 140 011	de / en / fr / it / es / pt / ru / sv
	SMM 535	T 140 010	de / en / fr / it / es / pt / ru / sv
Installation instructions for supervising unit LSU 35	T 140 365	multilingual (EDFI)	

# Contents

<b>1</b>	<b>General</b>	<b>9</b>
1.1	Purpose	9
1.2	Safety and the environment	10
1.2.1	Notice and warning symbols	10
1.2.2	Safety information	11
1.2.3	Disposal	12
1.3	Uses and applications	12
1.4	Abbreviations and terms	13
1.5	Product identification and designation compliant with 2014/34/EU	15
1.6	Guarantee	16
1.7	Product changes	16
1.8	Limitation	17
<b>2</b>	<b>Function</b>	<b>18</b>
2.1	General operating principle	18
2.2	Electrical functional principle	19
2.2.1	Power supply	19
2.2.2	Microcontroller	20
2.2.3	Programming / operation	20
2.2.4	Displays	21
2.2.5	Relay	21
2.2.6	Outputs	22
2.2.7	Inputs	22
2.2.8	Interfaces	22
2.2.9	Sensing tube monitoring	23
2.2.9.1	Sensitivity of sensing tube monitoring	24
2.2.10	Differential response behaviour	25
2.2.11	Maximum response behaviour	25
2.2.12	Temperature compensation	25
2.2.12.1	Internal temperature sensor	25
2.2.12.2	External temperature sensor	25
2.2.13	Defining the alarm thresholds	26
2.2.14	Alarm release	26
2.2.15	Pre-signal trigger	26
2.2.16	Sensing tube isolation	26
2.2.17	Day/night control & weekday control	26
2.2.18	Fault triggering	27
2.2.19	Event memory	27
2.2.20	Data logging on the SD memory card	27
2.2.21	Reset types	27
2.2.21.1	State reset	28
2.2.21.2	Hardware reset	28
2.2.21.3	Initial reset	28
2.2.22	ADW networking	29
2.2.23	Heating the evaluation unit below $-20^{\circ}\text{C}$ ambient temperature	29
<b>3</b>	<b>Design</b>	<b>30</b>
3.1	Mechanical	30
3.2	Electrical	32
3.3	Hardware / firmware	33
3.4	List of materials / components	34
3.5	Packaging	34

<b>4</b>	<b>Planning</b>	<b>35</b>
4.1	General aspects of planning	35
4.1.1	Standards, regulations, guidelines, approvals	35
4.2	Applications	36
4.3	Area of application	36
4.4	Planning aids	37
4.4.1	Planning with "ADW HeatCalc" calculation	37
4.4.2	Planning without "ADW HeatCalc" calculation	37
4.5	General information about system limits	38
4.5.1	System limits without "ADW HeatCalc" calculation	38
4.5.1.1	Normative system limits without "ADW HeatCalc" calculation	39
4.5.1.2	Non-normative system limits without "ADW HeatCalc" calculation (sensing tube monitoring)	40
4.6	Settings	41
4.7	Monitoring area	42
4.7.1	Tunnels	42
4.7.2	Space surveillance, car park halls, car decks on ships	43
4.7.3	Use when ambient temperature is high	44
4.7.4	Modernising existing systems	45
4.7.5	Other	45
4.8	Electrical installation	45
4.8.1	Installation cable requirements	46
4.8.2	Determining the conductor cross-section	47
4.9	Restrictions	48
4.10	Environmental influences	48
<b>5</b>	<b>Mounting</b>	<b>49</b>
5.1	Mounting guidelines	49
5.2	Dimensioned drawing / drilling plan for evaluation unit ADW 535-2HDx (-1HDx)	50
5.3	Material for the sensing tube	51
5.4	Types of mounting	51
5.4.1	Evaluation unit	51
5.4.2	Sensing tube	52
5.4.2.1	Overview of sensing tube design	52
5.4.2.2	Sensing tube ascent and mounting	54
5.4.2.3	Handling sensing cable in general	54
5.4.2.4	Deployment and mounting of detection coils and test coils	56
5.4.2.5	Testing the sensing tube	57
<b>6</b>	<b>Installation</b>	<b>59</b>
6.1	Regulations	59
6.2	Cable entry	60
6.3	Installing additional modules XLM 35, RIM 36, SIM 35	61
6.4	Electrical connection	62
6.4.1	Terminal assignment for the LMB 35 main board	63
6.4.2	Terminal assignment of LEB 35 extension board	63
6.4.3	Terminal assignment for SecuriLine eXtended module XLM 35	64
6.4.4	Terminal assignment for RIM 36 relay interface module	64
6.4.5	Terminal assignment of an SIM 35 serial interface module	64
6.5	Connection variants	65
6.5.1	Power supply	65
6.5.2	Reset input	66
6.5.3	Control	66
6.5.3.1	Control via voltage supply by means of auxiliary relay	67
6.5.3.2	Control via input "Reset external"	68
6.5.4	Connection to the FACP line	69
6.5.4.1	Connection to zone detection via relay alarm / fault	69
6.5.4.2	Connection to selective identification or addressable loop via relay alarm / fault	70
6.5.4.3	Connection to SecuriFire/Integral addressable loop from XLM 35	70
6.5.5	Open collector outputs	71
6.5.6	External temperature sensor	72

<b>7</b>	<b>Commissioning</b>	<b>73</b>
7.1	General	73
7.1.1	Connect ADW 535HDx via Ethernet with "ADW Config"	73
7.1.1.1	Topology of the connection between ADW 535HDx and PC	74
7.1.1.2	Adjust configuration on the PC	74
7.1.1.3	Adjust IP address on the ADW 535HDx	75
7.2	Programming	76
7.2.1	Configuration options	77
7.2.2	Relay allocation	79
7.3	Starting up	80
7.3.1	Commissioning with EasyConfig	80
7.3.2	Commissioning with "ADW Config" configuration software	81
7.3.3	Setting to pre-defined switch positions A1 to T3, W00 to W09	82
7.3.4	Setting and polling the date and time	84
7.3.5	Initial reset	85
7.3.6	Displaying the firmware version	86
7.3.7	Logging off additional modules XLM 35, RIM 36, SIM 35 and the SD memory card	86
7.4	Re-programming	87
7.4.1	Re-programming on the ADW 535HDx	87
7.4.2	Re-programming with "ADW Config" configuration software	87
7.4.3	Re-programming from SecuriFire / Integral with XLM 35	87
7.5	Upload new firmware to the ADW 535HDx	88
7.5.1	FW upgrade from SD memory card	88
7.5.2	FW upgrade from PC via "ADW Config" configuration software	89
7.6	Measurements	89
7.6.1	Reading out the set configuration and pressure values	90
7.6.2	Read out of the set IP configuration	92
7.7	Testing and checking	92
7.7.1	Test triggerings	93
7.7.2	Checking the alarm release	95
7.8	Commissioning protocol	95
<b>8</b>	<b>Operation</b>	<b>96</b>
8.1	Operation and display elements	96
8.2	Functional sequence of operation	97
8.3	Switch positions	98
8.4	Resetting	99
8.5	Displays	99
8.5.1	Displays on the housing surface	99
8.5.2	Displays on the LMB 35 main board	100
8.5.3	SD memory card operation	101
8.5.3.1	Data logging on the SD memory card	101
8.5.3.2	Meaning of the status abbreviations on the SD memory card and LEDs 1 – 7 on the LMB 35	102
8.5.4	Displaying and reading out the event memory	102
8.5.4.1	Procedure and interpretation of the event memory display	103
8.5.4.2	Event groups	104
8.5.4.3	Event codes within event groups	104
8.5.5	Operation and displays on the XLM 35	108
8.5.6	Operation and display on the SIM 35	108
8.5.7	Operation and display on the SMM 535	109
8.6	Operation from SecuriFire / Integral with XLM 35	109
<b>9</b>	<b>Maintenance and service</b>	<b>110</b>
9.1	General	110
9.2	Cleaning	110
9.3	Maintenance checks and function checks	111
9.4	Replacing units	112
9.4.1	Replacing the LSU 35 supervising unit	112
9.4.2	Replacing the LMB 35 main board	113
9.4.3	Replacing LEB 35 extension board	113
9.5	Disposal	114
9.5.1	Materials used	114

## Contents

<b>10</b>	<b>Faults</b>	<b>115</b>
10.1	General	115
10.2	Warranty claims	115
10.3	Finding and rectifying faults	116
10.3.1	Fault states	116
<b>11</b>	<b>Options</b>	<b>119</b>
11.1	Use in potentially explosive atmospheres	119
11.2	ADW networking	120
11.2.1	ADW networking via RS485 interface from SIM 35	120
11.2.2	ADW networking via Ethernet interface from LMB 35	121
<b>12</b>	<b>Article numbers and spare parts</b>	<b>122</b>
12.1	Evaluation unit and accessories	122
12.2	Sensing tube and accessories	122
<b>13</b>	<b>Technical data</b>	<b>123</b>
<b>14</b>	<b>List of figures</b>	<b>124</b>
<b>Document history</b>		<b>125</b>

# 1 General

## 1.1 Purpose

The ADW 535 / ADW 535HDx is an integrated line type heat detector with a response behaviour based on heat differential and/or maximum heat. Thanks to its self-check feature and the periodic, automatic test, the ADW 535 / ADW 535HDx is particularly suitable for use in applications where the legally prescribed functional and maintenance checks cannot be performed due to the given ambient conditions or only with difficulty.

The **ADW 535HDx** is suitable for use as operating material in **potentially explosive atmospheres in zones 2 and 22** in accordance with VDE 0165 and IEC 60079-10.

The ADW 535 / ADW 535HDx line type heat detector is available in four versions:

In thermoplastic housing for normal applications (standard, see T 140 358):

- ADW 535-1 for 1 sensing tube, 2 relays/OCs
- ADW 535-2 for 2 sensing tubes, 4 relays/OCs

**In the housing for extreme ambient conditions and Ex applications → current version:**

- ADW 535-1HDx for 1 sensing tube, 2 relays/OCs
- ADW 535-2HDx for 2 sensing tubes, 4 relays/OCs

The ADW 535HDx line type heat detector has three connections (4 expansion slots) for additional modules. The following modules can be fitted:

- XLM 35 SecuriLine eXtended Module (**not UL/ULC tested**)
- RIM 36 Relay Interface Module with 5 relays (2 units)
- SIM 35 Serial Interface Module



### Use in potentially explosive atmospheres

When using the ADW 535HDx in potentially explosive atmospheres, only the additional modules listed above may be installed in the ADW. The installation of other modules such as the **BX-OI3** or **line modules from external FACPs** is **not permitted**. Such modules may only be installed in separate Ex-approved housing and are the personal responsibility of the supplier or user of the modules (see also Sec. 6.5).

With the installation of an **XLM 35** SecuriLine eXtended module, the ADW 535HDx line type heat detector can be easily connected to the SecuriFire (SecuriLine eXtended) and Integral (X-Line) fire alarm systems via the addressable loop. Control operations and changes to the ADW device configuration can be carried out directly from the FACP. For this purpose the FACP configuration software “SecuriFire Studio” and “[Integral Application Center](#)” are used to start the “ADW Config” configuration software for access to the ADWs; the configuration software is then used to make changes to the ADW 535HDx ([Config over Line](#)).

A further expansion option is the **RIM 36** relay interface module. This module makes the individual alarms and the pre-signals “Diff” and “Max” available via relay contacts. The relays are also freely programmable via the “ADW Config” configuration software.

The **SIM 35** serial interface module is for networking multiple ADW 535HDx units via RS485 bus. Using the “ADW Config” configuration software, all ADW 535HDx units present in the network can be configured, visualised and operated from a PC. The SMM 535 is necessary as master module in the network and enables the connection to a PC.



### Notice

The normative alarm transmission of the ADW 535HDx to the superordinate centre does not take place via the ADW network. For that purpose the “Alarm”/“Fault” relays in the ADW, or the SecuriFire / Integral addressable loop are to be used from the XLM 35.

The present technical description contains all information essential for trouble-free operation. For obvious reasons only those details specific to individual countries and companies or special applications can be discussed if they are of general interest.

### 1.2 Safety and the environment

Provided the product is deployed by trained and qualified personnel in accordance with this document, and provided the safety symbols all notices are observed, there is no danger to persons or property under normal conditions and when used properly. The product fulfils the requirements ensuring personal safety and environmental protection during operation. National and state-specific laws, regulations and directives must be observed and adhered to in all cases.

Observe these danger notices. They help prevent accidents and damage.

#### 1.2.1 Notice and warning symbols

The following notice and warning symbols are used to draw attention to hazards and special properties.



#### **Danger**

The product may represent an immediate danger with a high level of risk to persons if the notice is not duly observed. If the danger is not avoided, death or serious injury may result.



#### **Warning**

The product may represent a possibly imminent danger with a medium level of risk to persons if the notice is not duly observed. If the danger is not avoided, death or serious injury may result.



#### **Caution**

The product may represent a possibly imminent danger with a low level of risk to persons if the notice is not duly observed. If the danger is not avoided, a minor injury may result.



#### **Notice**

If this notice is not observed, the product may malfunction, may cause property damage, or may be harmful to the environment.

## 1.2.2 Safety information



### Use in potentially explosive atmospheres

Before handling, mounting and commissioning the ADW 535HDx in **potentially explosive atmospheres**, the following safety information and descriptions in the **Operating Instructions, T 140 459**, must be carefully read and observed.

#### Target group:

Electricians in accordance with [BetrSichV](#), IEC 60079-17 and trained persons.

The national accident prevention regulations and safety regulations as well as the following safety information designated with the following symbol must be observed.



- This operating material (evaluation unit) is not permitted to be used in potentially explosive atmospheres of zones 0, 20, 1 and 21.
- Observe the technical data specified on this operating material.
- Conversions and modifications to this operating material are not permitted.
- This operating material must be operated in accordance with the intended purpose and only when in an undamaged and trouble-free state.
- Only original parts from the manufacturer as replacement.
- Repairs may be performed only by the manufacturer.



### Read the user instructions



To ensure safe and proper use, it is absolutely necessary to read the instructions and other documentation accompanying the product before use and to keep such documentation at hand for later reference. It is imperative that the danger information in particular is observed.



### Electrostatic discharge



The product includes electronic components that are sensitive to electrostatic discharge (ESD). Contact with persons or objects can cause an electrostatic discharge that damages or destroys the product. ESD bands for preventing electrostatic discharge are used for grounding persons and for equipotential bonding.

### 1.2.3 Disposal



#### Electrical and electronic devices and batteries

It is not permitted to dispose of electrical and electronic devices or batteries in the domestic rubbish. As the end user you are legally obliged to return them. Used electrical and electronic devices as well as batteries can be returned to the seller or taken to a designated recycling centre (e.g. a community collection point or dealer) at no cost.



#### Lead batteries

It is not permitted to dispose of lead batteries in the domestic rubbish. As the end user you are legally obliged to return them. Used lead batteries can be returned to the seller or taken to a designated recycling centre (e.g. a community collection point or dealer) at no cost.



#### Recycling

The product and its components including their packaging consist of recyclable material and can be disposed of for recycling purposes as described in this document.

### 1.3 Uses and applications

Thanks to its excellent properties under extreme ambient conditions, the ADW 535HDx is used wherever problems are to be expected owing to latent disturbance variables during operation such that optimal protection can no longer be guaranteed with conventional point detectors. This includes:

- Ex zones 2 and 22 acc. to VDE 0165 and IEC 60079-10;
- Paint spray and paint shops, tank storage, chemical industry, underground mining (see also Sec. 4.9);
- Road tunnels, railway and underground railway tunnels in extreme ambient conditions;
- Loading platforms, car park halls, car decks on ships, in extreme ambient conditions.

The ADW 535HDx can also be deployed in areas where conventional point detectors are used. Local regulations and provisions must be observed from case to case.

When control-unit-specific alarm transmitters, line monitoring elements etc. are used, the ADW 535HDx can be connected via its potential-free change-over contacts to all common fire alarm systems virtually without restrictions.



#### Use in potentially explosive atmospheres

When using the ADW 535HDx in potentially explosive atmospheres, **only** the **RIM 36**, **XLM 35** and **SIM 35** additional modules may be installed in the ADW. The installation of other modules such as the **BX-OI3** or **line modules from external FACPs** is **not permitted**. Such modules may only be installed in separate Ex-approved map cases and are the personal responsibility of the supplier or user of the modules (see also Sec. 6.5).

The receiver modules (opposite side) of the XLM 35 and SIM 35 additional modules must be positioned outside of the Ex-zone in the safe area.

## 1.4 Abbreviations and terms

The following abbreviations and terms are used in this document. Other abbreviations can be found in Sec. 8.5.3.2 (status abbreviations on SD memory card). The abbreviations for tube material and accessories are listed in a separate document: T 140 362 (see also Sec. 5.3).

µC	= Microcontroller / microprocessor
ABS	= Acrylonitrile-butadiene styrene (plastic)
ADW	= Line type heat detector
ADW Config	= Configuration software for ADW 535 / ADW 535HDx
ADW HeatCalc	= Calculation software for the sensing tube, "ADW HeatCalc"
AI	= Alarm
ART 535	= External reference temperature sensor (ADW reference temperature-sensor)
ATEX	= <b>AT</b> mosphères <b>EX</b> plosibles = potentially explosive atmospheres
CE	= <b>Communauté Européenne</b> (European Community)
Cu	= Copper
Default	= Pre-set values / settings
DIN	= <b>Deutsche Industrie Norm</b> (German industry standard)
EasyConfig	= Commissioning procedure without the "ADW Config" configuration software
EDP	= Electronic data processing
EEPROM	= Memory component for system data and ADW configuration
EMC	= Electromagnetic compatibility
EN 54-22	= European product standard about line type heat detectors
Ex-zone	= Area subject to explosion hazards
FACP	= Fire alarm control panel
FAS	= Fire alarm system
Fault / Fit	= General fault
Flash PROM	= Memory component for firmware
Flush mounting / surface mounting	= Flush mounted, surface mounted
FW	= Firmware
GND	= Supply ground (minus (-) pole)
H-AI	= Main alarm
HF	= High frequency
HW	= Hardware
IEC	= International Electrotechnical Commission
Initial reset	= Acquiring sensing tube basic data when commissioning the ADW 535HDx
KFI	= Korea Fire Institute (Korean inspection)
LEB 35	= Expansion units for second sensing tube (LTHD extension board)
LED	= Light-emitting diode (indicator)
LMB 35	= ADW main board (LTHD main board)
LSU 35	= Supervising unit (LTHD supervising unit)
Manufacturer	= Securiton
mbar	= Unit for pressure
NFPA 72	= National Fire Protection Association – National Fire Alarm-Code (US guideline fire alarm system)
NO / COM / NC	= Relay contacts: NO (normally open), COM (common), NC (normally closed)
OC	= Open collector output
OEM	= Original Equipment Manufacturer (reseller)
PA	= Polyamide (plastic)
PC	= Personal computer
PC	= Polycarbonate (plastic)
PMR 81	= Semi-conductor relay
PSB 35	= Pressure sensor unit in supervising unit (Pressure Sensor Board)

→→

## General

Continuation:

<a href="#">PTFE</a>	= Teflon (plastic)
PWR	= Power input / power display (power)
PWR-R	= Redundant power input
RAM	= Memory component
ResExt	= Reset external (state reset via input)
RIM 36	= Relay interface module
RoHS	= Restriction of Certain Hazardous Substances (eco-friendly manufacturing processes)
RPM 535	= Remote pressure-sensor module RPS 535 (in preparation)
RPS 535	= Remote pressure sensor (in preparation)
Rst	= Hardware reset (restart)
RVS	= Guidelines and regulations for roads and streets (AT)
SecuriFire	= FAS system
SecuriLine	= Fire detector addressable loop
SIM 35	= Serial Interface Board
SMM 535	= Serial Master Module
St	= Stainless steel (VA)
SW	= Software
Te.	= Terminal
UMS 35	= Universal Module Support
Update / Release	= Renewal / update of the firmware
<a href="#">V-AI</a>	= Pre-alarm
VDC	= Direct current voltage
VdS	= <a href="#">VdS Schadenverhütung GmbH (DE)</a> (Association of indemnity insurers, Germany)
VKF	= <a href="#">Vereinigung Kantonalen Feuerversicherungen</a> (cantonal fire insurance union, Switzerland)
<a href="#">VS</a>	= Pre-signal
Watchdog	= Monitoring of the microcontroller
XLM 35	= SecuriLine eXtended module

### 1.5 Product identification and designation compliant with 2014/34/EU

For identification, the ADW 535HDx and its units have rating plates or identification plates.  
The following product identifications apply:

#### Rating plate on the ADW 535HDx and identification on the packaging

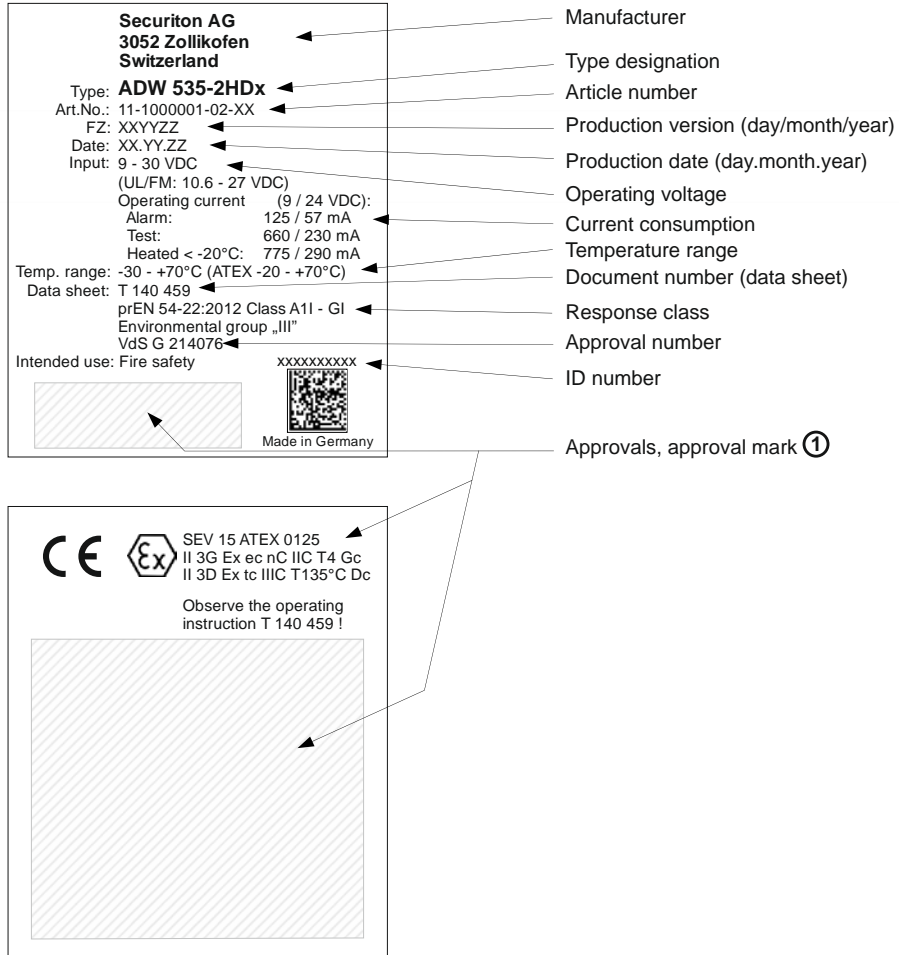

① Additional conformity marks may be affixed to a second rating plate or to an extended area of the rating plate (wider plate).

## General

### Identification on the packaging of the printed circuit boards fitted

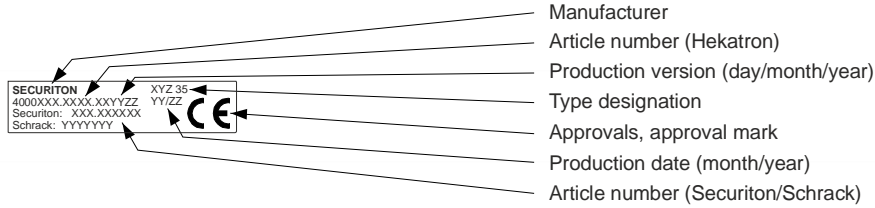

#### Notice

The rating plates, type designations and/or identifications on devices and printed circuit boards must not be removed, written over or defaced in any way.

Many products, such as accessories and mounting materials, are identified only with a sticker showing the article number. The manufacturer identifies these parts by article number.

### 1.6 Guarantee



#### Notice

The product may be operated only with the hardware, software and commissioning media designated and delivered by the manufacturer. Any unauthorised intervention in the hardware and/or software or the use of non-system products is prohibited and may result in malfunctions and/or damage to the product. If this is not observed, all guarantee and warranty rights with respect to the manufacturer of the product will become null and void. Further, non-observance of the user instructions as well as improper maintenance and repair work void the guarantee and product liability.

### 1.7 Product changes

The hardware is considered to comprise the complete ADW 535HDx evaluation unit and all units belonging to the ADW 535HDx line type heat detector, such as sensing tube and mounting material.

The firmware is stored on the Flash-PROM in the ADW 535HDx. An EEPROM is fitted for storing and saving system-specific parameters.



#### Notices

- The ADW 535HDx is to be operated only with the appropriate original firmware from the manufacturer. Any unauthorised intervention in the firmware or the use of non-original firmware may result in malfunction and/or in damage to the device. Furthermore, all guarantee and warranty rights with respect to the manufacturer of the ADW 535HDx will become null and void as a result.
- We recommend always using the most recent SW version. In the event of changes by the manufacturer to the hardware or software of a product, there is no guaranteed update for existing systems.

## 1.8 Limitation

The response behaviour of the ADW 535HDx is tested in compliance with (see also Sec. 4.1.1):

- **EN 54-22** = classes **A11** to **G1**;
- **UL 521 – ULC-S530-M91** = according EN 54-22 classes **A11** to **G1**;
- **FM 3210 / NFPA 72** = classes **Ordinary, Intermediate, High** – **Spacings** 15 ft / 20 ft / 25 ft / 30 ft / 40 ft;
- **RVS** = in accordance with the requirements for road tunnels (AT);
- **KFI** = in accordance with the requirements for road tunnels (KR).

This operating material complies with the requirements of EN 60079-0, EN 60079-7, EN 60079-15, EN 60079-31 and EC Directive “Equipment and protective systems intended for use in potentially explosive atmospheres” (2014/34/EU) and “Electromagnetic compatibility” (2014/30/EU). It was developed, manufactured and tested based on the latest technical standards and in compliance with ISO 9001.

This operating material is suitable for use in potentially explosive atmospheres of **zone 2 and zone 22** in compliance with VDE 0165 and IEC 60079-10.

## 2 Function

### 2.1 General operating principle

The working principle of the ADW 535HDx is based on the volume expansion of gas due to heating in a pneumatically sealed system and the consequent pressure increase. If the pressure in the sensing tube rises to values as defined by the ADW 535HDx firmware (time basis, pressure limit value in mbar), the system triggers an alarm. The alarm is indicated visually on the ADW 535HDx and can be transmitted via a potential-free change-over contact to a superordinate fire alarm control panel.

The pneumatically sealed system is composed of the sensing tube that is locally installed in the area to be monitored and is sealed at the end with a terminal screw fitting. The sensing tube is connected to the ADW 535HDx evaluation unit in which the pneumatic line is wired to the **LSU 35** supervising unit. The LSU 35 consists of a fully electronic differential pressure sensor, a pressure pump and a step motor. There is regular ambient air in the entire pneumatic volume.

The ADW 535HDx is available as a system with one or two sensing tubes. The ADW 535HDx with two sensing tubes has two completely independent pneumatic circuits; thus it also has two LSU 35 supervising units. All control circuitry and measured value recordings are individually designed for each sensing tube.

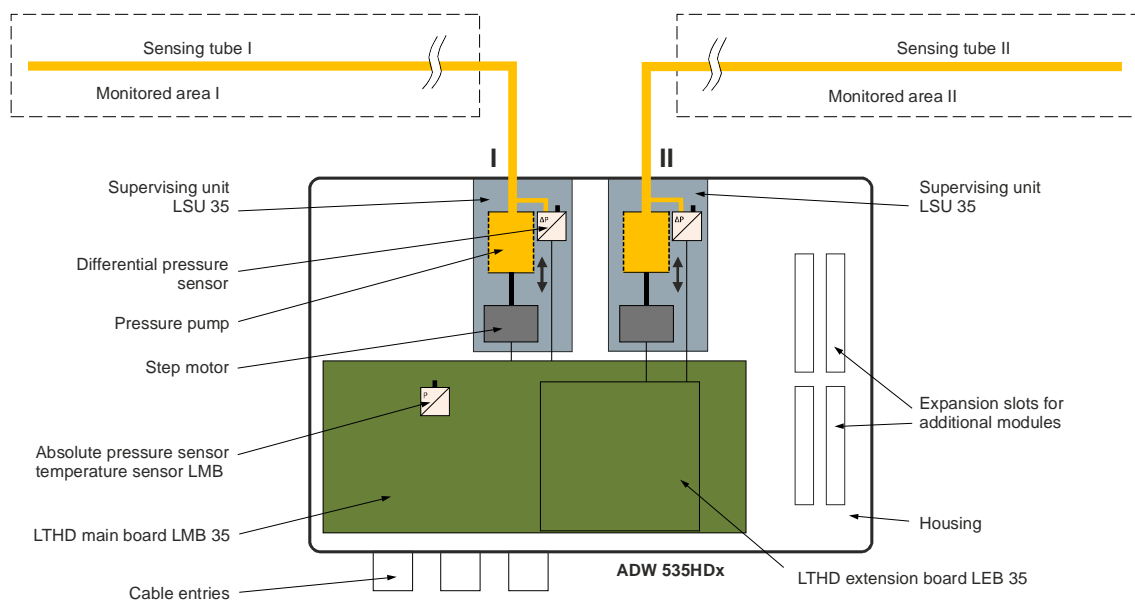
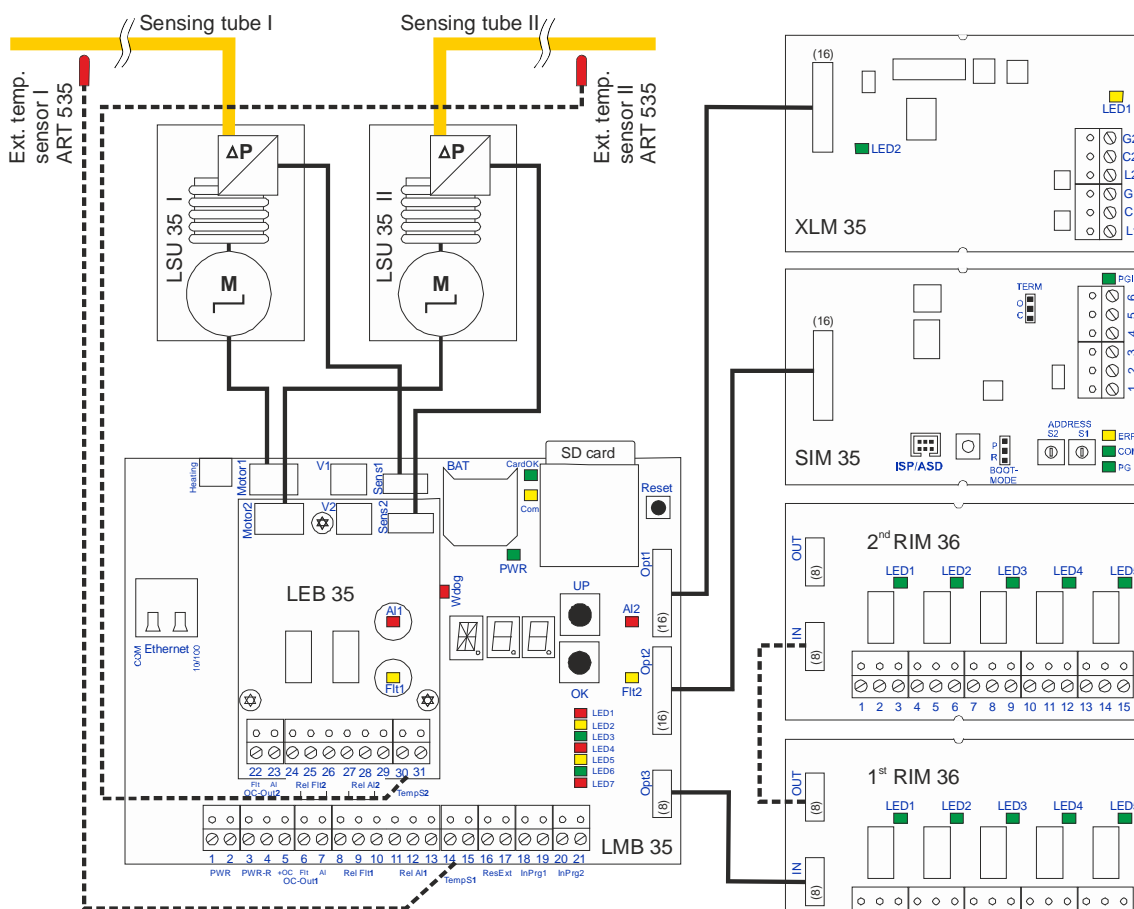

Fig. 1 General operating principle

## 2.2 Electrical functional principle



Connection possibilities of the additional modules:  
 1 x XLM 35 to "Opt 1" (also possible to "Opt 2")  
 1 x SIM 35 to "Opt 2" (also possible to "Opt 1")  
 2 x RIM 36 to "Opt 3", cascaded

Fig. 2 Block diagram

### 2.2.1 Power supply

The operating voltage of the ADW 535HDx is +9 to +30 VDC (UL/FM = 10.6 to 27). On the LMB 35 main board, 3.3 and 6 VDC of the operating voltage is diverted for internal voltage use.

The operating voltage is monitored on the LMB 35 for undervoltage. If the operating voltage falls below 8.5 VDC (+0 / -0.3 VDC), the ADW 535HDx triggers an undervoltage fault.

## 2.2.2 Microcontroller

The entire program and switching sequence is controlled by a microcontroller. The firmware is stored on a Flash-PROM. System-specific configurations are stored in an EEPROM.

The program is monitored by the internal watchdog of the microcontroller. In the event of a failure of the microcontroller circuit, an emergency fault is triggered. This is signalled on the device by the "Fault" LED remaining continuously lit. The relay "Fault" (**Flt1** and **Flt2**) switches.

## 2.2.3 Programming / operation

The operation of the ADW 535HDx line type heat detector in normal operation (after commissioning) is limited to switching On/Off and resetting a triggered event (alarm, fault). Operation is usually with the FACP and entering the functions "Group(s) On/Off" and "Reset".

With the **EasyConfig** switch position **R** (**R00** = state reset) on the LMB 35 or by briefly actuating the "Reset external", the triggered events can be reset on the ADW 535HDx on site. The reset is possible only if the triggered event is no longer pending (e.g. pressure in the sensing tube undershoots the triggering value). The application of a continuous signal at the "Reset external" input also deactivates (switches off) the ADW 535HDx (see also Sec. 2.2.5 and 6.5.2).



### Notice

A local reset does not reset a superordinate FACP. It may happen that the reset in the ADW 535HDx triggers a fault in the superordinate line of the FACP.

To aid commissioning the ADW 535HDx, there are two 7-segment displays, an alphanumeric display, and two buttons ("UP" and "OK") inside the device on the LMB 35 main board. These elements render a kind of rotary switch function, i.e. displays and positions can appear in the range of **A00** to **Z99**.

These elements are used when commissioning the ADW 535HDx. Device settings for pre-defined system limits can also be called up (**EasyConfig**). These pre-defined positions are stored with normative values for response sensitivity and various sensing tube lengths. The **EasyConfig** procedure allows the device to be commissioned without the "ADW Config" software. If system-specific programming is necessary (e.g. after a calculation with "ADW HeatCalc" or when programming additional relays on the RIM 36), the "ADW Config" configuration software is to be used.

**Fig. 3** shows the workflow for defining and programming project-specific device functions.

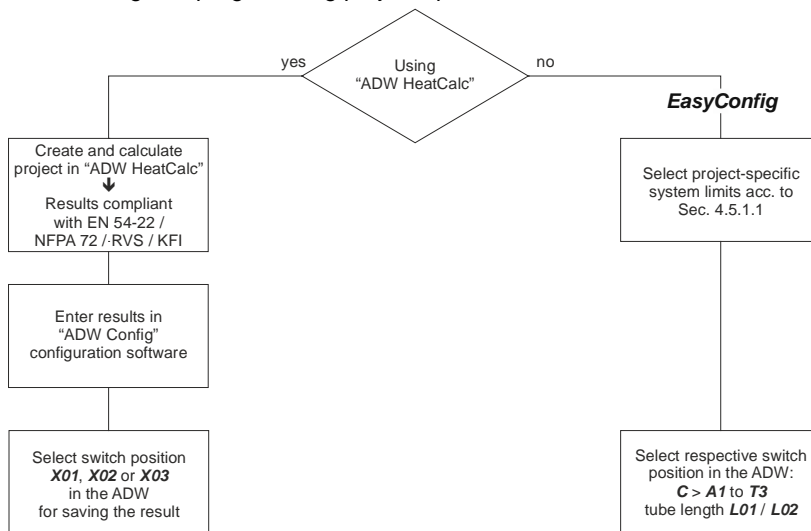

**Fig. 3 Workflow for project-related programming**

The definitions of the pre-defined settings and the operator structure are found in Sec. 4.5.1.1, 7.2.1 and 8.3.

## 2.2.4 Displays

The events are indicated with LEDs on the LMB 35 main board and made visible by fibre optic rods on the surface of the housing. Depending on the device version, different displays are present:

- ADW 535-1HDx                      Operation, fault I, alarm I, pre-signal I.
- ADW 535-2HDx                    Additionally: Fault II, alarm II, pre-signal II.

Depending on the event, the LEDs are either continuously lit or flash at different frequencies (see Sec. 8.5).

## 2.2.5 Relay

Depending on the device version and the additional modules installed, the ADW 535HDx has several relays with potential-free change-over contacts with the following assignments:

Unit	Relay designation	Version	Function, events
LMB 35	Rel. Flt1: ① Fault I	ADW 535-1HDx	Fault; all events of sensing tube I + gen. faults ADW inactive
	Rel. Al 1: Alarm I		Sensing tube I alarm release
LEB 35	Rel. Flt2: ① Fault II	ADW 535-2HDx	Fault; all events of sensing tube II + gen. faults ADW inactive
	Rel. Al 2: Alarm II		Sensing tube II alarm release
1 <sup>st</sup> RIM 36 (from LMB 35)	Rel. 1 ②	All	Diff alarm of sensing tube I or freely programmable
	Rel. 2 ②		Max alarm of sensing tube I or freely programmable
	Rel. 3 ②		Pre-signal Diff alarm of sensing tube I or freely programmable
	Rel. 4 ②		Pre-signal Max alarm of sensing tube I or freely programmable
	Rel. 5 ②		Alarm LMB temperature sensor
2 <sup>nd</sup> RIM 36 (cascaded from 1 <sup>st</sup> RIM 36)	Rel. 1 ②	ADW 535-1HDx	Freely programmable
	Rel. 2 ②		Freely programmable
	Rel. 3 ②		Freely programmable
	Rel. 4 ②		Freely programmable
	Rel. 5 ②		Freely programmable
2 <sup>nd</sup> RIM 36 (cascaded from 1 <sup>st</sup> RIM 36)	Rel. 1 ②	ADW 535-2HDx	Diff alarm of sensing tube II or freely programmable
	Rel. 2 ②		Max alarm of sensing tube II or freely programmable
	Rel. 3 ②		Pre-signal Diff alarm of sensing tube II or freely programmable
	Rel. 4 ②		Pre-signal Max alarm of sensing tube II or freely programmable
	Rel. 5 ②		Freely programmable



### Notices

- ① The “Flt1” (and “Flt2”) relays are picked up in the quiescent state → Contact terminals 10/8 (24/22) closed, 10/9 (24/23) open (ADW 535HDx under voltage; no fault event present).
- ② Depending on the device version, the relays are either configured with the above named criteria or freely programmable using the “ADW Config” configuration software (see Sec. 7.2.1 and 7.2.2).

## Function

### 2.2.6 Outputs

OC outputs are on the ADW 535HDx. Parallel indicators, feedback indicators or other consumers (relays) can be connected to these outputs. Depending on the device version, the outputs are configured with the following criteria (see also Sec. 6.5.5):

Unit	OC designation	Version	Function, events
LMB 35	OC-Out1; Flt	ADW 535-1HDx	Fault; all events of sensing tube I + gen. faults ADW inactive
	OC-Out1; AI		Sensing tube I alarm release
LEB 35	OC-Out2; Flt	ADW 535-2HDx	Fault; all events of sensing tube II + gen. faults ADW inactive
	OC-Out2; AI		Sensing tube II alarm release

### 2.2.7 Inputs

The ADW 535HDx has a **“Reset external”** (**“ResExt”**) input used to reset the device to its normal state after an event. The input is potential-free (opto-isolator). It can be actuated both on the “plus” and on the “minus” side. The input operates in the 5 to 30 VDC range and has a pulse bandwidth of 0.5 to 10 s. When a continuous signal is applied for longer than 20 s, the ADW 535HDx is deactivated (fault state) (see also Sec. 6.5.2). Switching inactive via the “Reset external” input works only if the ADW 535HDx is not equipped with an XLM 35.

The inputs **“InPrg1”** and **“InPrg2”** (InPrg2 = reserve, no function) are potential-free (opto-isolator) and can be actuated “plus” side or “minus” side in the range of 5 to 30 VDC. Input **“InPrg1”** is assigned the function **“day/night control from FACP”** by default.



#### Notice

The inputs are not line monitored.

### 2.2.8 Interfaces

Depending on the device version and installed additional modules, the ADW 535HDx has the following interfaces:

Unit	Designation	Version	Function, events
LMB 35	EthNet	All	Configuration with “ADW Config” Update of the firmware
XLM 35	L1 / C1 / G1 // L2 / C2 / G2	All	SecuriFire / Integral addressable loop
SIM 35	GND / D + / D –	All	RS485

## 2.2.9 Sensing tube monitoring



### Notice

A prerequisite for the proper functioning of sensing tube monitoring is the acquisition of basic data **for every sensing tube** by means of an **initial reset** when the ADW 535HDx is commissioned (see also Sec. 2.2.21.3).

#### Prerequisite, initial reset:

The basic data acquired when an initial reset is performed is used for monitoring the sensing tube. The pressure pump is actuated with the step motor for an initial reset, whereby the pressure levels in the closed sensing tube are determined and stored as “**Initial reset pressure**” (nominal value). The pressure increase depends on the length of the connected sensing tube and comprises the reference basic data on the sensing tube.

#### Monitoring and interruption detection:

The differential pressure sensor on the **LSU 35** supervising unit continuously measures the present pressure in the sensing tube. The pressure in the sensing tube varies continuously due to the “normal” ambient temperature changes. If the pressure does not move out of a small pressure window over a certain period of time (nearly “zero”), the step motor starts up and pumps until the pressure in the sensing tube is again outside the pressure window (→ pressure offset = over- or underpressure). Normally (sealed sensing tube), this mechanism causes a certain minimum over- or underpressure. If there is a leak on the sensing tube caused by an interruption, the pressure in the sensing tube rapidly changes to “zero” → this results in a “Break assumption”. In this state a test procedure is started (step motor and pressure pump) and the pressure sequence is measured. If the required values are not reached, a “**Sensing tube interruption fault**” is triggered.

#### Cyclical test procedure:

In a cyclical test procedure, after a selected **interval** the pressure pump is actuated with the step motor and the pressure sequence is measured. If the required values are not reached, the ADW 535HDx starts one (or more) **follow-up procedures** after a **waiting time**. A negative result after the last follow-up test procedure (based on the points listed below) causes a “**fault**” on the ADW 535HDx. If, however, the target values are reached after a test procedure, the ADW 535HDx switches to normal operation after the procedure.

Depending on the deviation from the basic data, the following may apply to the sensing tube and/or pneumatic systems:

- No pressure increase (below target value)
  - Sensing tube is open or not connected, pressure pump or step motor is defective
- Ratio of max./min. pressure increase is too small (below target value)
  - Leak in the sensing tube
  - Interruption in the sensing tube (if max./min. ratio < 1.5)
- Pressure increase too high (over target value)
  - Crushing in the sensing tube, the current sensing tube length no longer corresponds to the installed tube length.

#### Alternative test not EN 54-22 compliant:

According to **EN 54-22**, pipe breakage in the sensing tube must be signalled within **300 s** as a fault. This requirement is met on the ADW 535HDx in the **EasyConfig** switch positions **C > A1 to G** when using the procedure as described under “Monitoring and interruption detection”.

For applications in extreme environments with increased disturbance factors (**outside of EN 54-22**), in addition to **EasyConfig** switch positions **C > A1 to G**, in a further step the switch positions **W04 to W09** can be used. They use the **cyclical test procedure** with various sensitivity levels (**low, medium, high**, see Sec. 2.2.9.1) and greater repetition factors of 2 x / 4 x (follow-up test procedure). See also Sec. 4.5.1.2.



### Notice

Switch positions **W04 to W09** may be used only after consulting with the manufacturer. The configured values they contain concerning sensing tube monitoring are **not** tested in accordance with EN.

## Function

### 2.2.9.1 Sensitivity of sensing tube monitoring

Depending on the selected sensitivity level “**Low**”, “**Medium**” or “**High**” (can be changed with *EasyConfig* switch positions *W01* to *W09* or with the “ADW Config” configuration software), the following thresholds apply to the **Initial reset** and the **cyclical test procedure**.



#### Notice

**Interruption detection compliant with EN 54-22:** The sensitivity levels are not in effect for detection of the abrupt pressure drop compliant with EN 54-22.

Sensitivity:	in effect for <b>initial reset</b> :			in effect for <b>cyclical test</b> : ⑥ / ⑦		
	Leakage test ① (max. disturbance, in mbar/min.)	Sealing check ② (max. pressure drop, in mbar for 30 s)		Length test ③ (tolerance, in %, at least 5 m)	Leakage test ④ (max. disturbance, in mbar/min.)	Crushing test ⑤ (deviation from the initial reset value, in %)
		< 30 m	> 30 m			
<b>Low</b>	7	-0.6	-0.5	20	7	approx. -45
<b>Medium</b>	3.5	-0.35	-0.25	15	3.5	approx. -25
<b>High</b>	2	-0.25	-0.15	10	2	approx. -15
<b>Notes about initial reset:</b>						
① <b>Leakage test:</b> The leak test evaluates the max./min. ratio and compares it to a length-dependent limit value. If this limit value is undershot, the disturbance corresponds to the above specified sensitivity level. <b>Notice:</b> A pending disturbance (temperature change in the monitoring area) can falsify the result and cause an initial reset fault (leak). Possible disturbances: <b>Low</b> = approx. 2°C/min; <b>Medium</b> = approx. 1°C/min; <b>High</b> = approx. 0.6°C/min.						
② <b>Sealing check:</b> For the initial reset from “ADW Config” you can select whether the sealing check is to be performed (always performed with initial reset from <i>EasyConfig</i> ). The limit values are dependent on the sensing tube length. <b>Notice:</b> A pending disturbance (fluctuating temperature drop during the observation time) can cause a faulty result and trigger an initial reset fault (sealing check).						
③ <b>Length test:</b> For the initial reset from “ADW Config” you can select whether the length check is to be performed (always performed with initial reset from <i>EasyConfig</i> ). A tolerance limit of 5 m applies in all sensitivity levels for the length check. <b>Notice:</b> A pending disturbance (different temperatures in the monitoring area and in the area of the evaluation unit) can cause a faulty result and trigger an initial reset fault (length check).						
<b>Notes about the cyclical test:</b>						
④ <b>Leakage test:</b> Is not evaluated if the pressure is outside the range of -30 to +30 mbar. The leak test evaluates the max./min. ratio and compares it to a length-dependent limit value. If this limit value is undershot, the disturbance corresponds to the above specified sensitivity level. <b>Notice:</b> A pending disturbance (temperature change in the monitoring area) can falsify the result and cause a test fault (leak). Possible disturbances: <b>Low</b> = approx. 2°C/min; <b>Medium</b> = approx. 1°C/min; <b>High</b> = approx. 0.6°C/min.						
⑤ <b>Crushing test:</b> For the crushing test, a deviation from the determined sensing tube length is decisive for an initial reset. When using an ART 535 external temperature sensor (adjustment), the deviation from the set sensing tube length is decisive. <b>Notice:</b> A pending disturbance (different temperatures in the monitoring area and in the area of the evaluation unit) can cause a faulty result and trigger a test fault (crushing check).						
⑥ Is not performed if the pressure is outside the range of -300 to +300 mbar.						
⑦ Can be configured for deactivation (with switch positions <b>X</b> and <b>W</b> ).						

### 2.2.10 Differential response behaviour

The differential pressure sensor on the **LSU 35** supervising unit continually measures the pressure in the sensing tube compared to the ambient pressure. The sensor signals are mathematically evaluated by the microprocessor and can be used for computational processing and forming the differential response behaviour. If the pressure increases in the time frame defined by the software (**Diff pressure** = mbar/min.), the **alarm verification time** is started.

During the **alarm verification time**, the continued rise of the absolute pressure is monitored. If it exceeds a defined **delta pressure value** within the alarm verification time, the ADW 535HDx triggers a “**Diff alarm**”.

The sensing tube partial length (detection length), which corresponds to the normatively defined monitored area, is decisive for the “**Diff alarm**”. According to **EN 54-22** this is for example **10 m**. The remaining length of the sensing tube in the monitored area and the supply line determine the length-dependent size of the differential pressure value and the delta pressure value (ratio of “**detection length**” to the “**maximum length of the sensing tube**”; see also **Fig. 8**; “**D**” to “**B**”).

### 2.2.11 Maximum response behaviour

The maximum response behaviour of the ADW 535HDx is designed so that a pressure value (**Max pressure** = mbar) that corresponds to a certain maximum temperature triggers an alarm. Slowly and steadily increasing pressure values over a longer period of time that are not within the detection range of the differential response behaviour (e.g.  $\Delta T = 40^\circ\text{C}/\text{h}$ ; overheating of an oven) are thus evaluated as “**Max alarm**” when a certain limit value is reached.

For the “**Max alarm**” it is assumed that heat always impinges on the entire sensing tube that is in the monitored area. The pressure value for the “**Max alarm**” is therefore only minimally dependent on the sensing tube length (only ratio of “**length in the monitored area**” to the “**length of the supply line**”; see also **Fig. 8**; “**C**” to “**A**”). There is, however, an additional dependency concerning the response-behaviour-related, typical application temperature and the decreasing factor “mbar/ $^\circ\text{C}$ ” at an increased application temperature.

### 2.2.12 Temperature compensation

An internal temperature sensor in the evaluation unit (on the LMB 35) or optionally in the ART 535 external temperature sensor in the area of the sensing tube (for each sensing tube) continuously measures the current ambient temperature and compensates (adjusts) the maximum response behaviour. This corrects any minimal leakage in the sensing tube. Further, the trigger thresholds function “independently” of the temperature during commissioning. Adjustment (compensation) to a prevailing temperature takes place periodically and only if the pressure and the temperature remain unchanged for a certain length of time.

If an external ART 535 temperature sensor is used on a sensing tube for the compensation, the compensation is inactive beginning at the internal temperature sensor for the concerned sensing tube.

#### 2.2.12.1 Internal temperature sensor

The temperature sensor on the LMB 35 triggers an “**LMB temperature sensor alarm**” if the temperature exceeds  $80^\circ\text{C}$ . The alarms of **both sensing tubes together** are triggered (alarm I and alarm II). Also, provided the evaluation unit is located within the monitored area, the temperature sensor on the LMB 35 is used for the temperature compensation.

#### 2.2.12.2 External temperature sensor

The ART 535 external temperature sensor is primarily for temperature compensation and is used in the following cases (see also Sec. 6.5.6):

- Applications compliant with EN 54-22, classes CI to GI;
- always (for all response grades or applications), as soon as the application temperature in the monitored area deviates more than  $20^\circ\text{C}$  from the temperature of the evaluation unit.

An “**ext. alarm temperature sensor**” (per sensing tube) can be assigned to the external temperature sensor with the “ADW Config” configuration software (configurable trigger point). When the set temperature is exceeded, the alarm of the concerned sensing tube is triggered (alarm I or alarm II).

### 2.2.13 Defining the alarm thresholds

The values required for defining the alarm threshold (Diff pressure, alarm verification time, delta pressure and Max pressure) are pre-specified in the **EasyConfig** switch positions according to the relevant standard or can be system-specifically programmed with the “ADW Config” configuration software (based on the calculation results of the “ADW HeatCalc” calculation software).

### 2.2.14 Alarm release

The ADW 535HDx triggers an “Alarm” (per sensing tube) when one of these events occurs: “Diff alarm”, “Max alarm” or “Alarm temperature sensor LMB” (or “Alarm ext. temperature sensor”). The **AI relay**, the **AI LED** and the **AL OC output** are actuated.

### 2.2.15 Pre-signal trigger

Using the “ADW Config” configuration software, you can program a pre-signal trigger on the ADW 535HDx for the **Diff alarm** and **Max alarm** (individually) (default = switched off, without latching). The trigger threshold can be assigned in 5% increments of the alarm threshold. There are two RIM relays by default for the pre-signals (individually); they are indicated together via the **AI LED** (flashing, 1 s cycle).

### 2.2.16 Sensing tube isolation

This function is used to place the ADW 535HDx in an isolated state using the “ADW Config” configuration software (per sensing tube). This means that test alarms can then be triggered on the ADW 535HDx without activating superordinate systems (FACP) (relays, OC outputs, XLM do not trigger). When the “Isolate” function is switched on, a fault is triggered on the ADW and forwarded to the superordinate centre. On the ADW the “Fault” LED is then continuously lit.

### 2.2.17 Day/night control & weekday control

The ADW 535HDx can be adapted to operational processes (e.g. in extreme environments with increased disturbance variables during working hours) using the day/night control. When the day/night control is activated along with the required weekdays, different trigger thresholds, pre-signal allocations (trigger level only, not relays) and test parameters can be assigned.



#### Notices

- Improper parameter changes in day/night operation may result in non-compliance with the EN 54-22 norm.
- Day/night control can be used only via the “ADW Config” configuration software.
- Day/night control is effective only on the activated weekdays (“ADW Config”) and in switch positions **X01 – X03**.
- On non-activated days of the week, night mode of operation is always selected.
- In addition to the watchdog indicator (flashing point in the left segment display), the point is also continuously lit on the right segment display whenever the day/night control is active (only with the selected switch positions **X01 – X03**).

### 2.2.18 Fault triggering

If a fault occurs on the ADW 535HDx, the “Fault” relay is de-energised and the “Fault” display is activated. In the event of a fault, the fault profile can also be localised using the event code display on the LMB 35 (switch position **E**) (see also Sec. 8.5.4.3 and 10.3.1). The following events trigger a fault (a selection):

- Interruption/leak/crushing fault (single)
- Pressure sensor / test fault (single)
- External temperature sensor fault
- LMB 35 to LEB 35 communication fault
- Communication fault LMB 35 to XLM 35 / RIM 36 / SIM 35 / SD memory card (single)
- Emergency fault (microcontroller failure)
- Clock fault
- Undervoltage fault (8.5 VDC, +0 / –0.3 V)
- Power supply fault (no voltage on the ADW, no “Fault” display)
- ADW inactive via “Reset external” input.



#### Notice

The “Fault” relay is picked up in the quiescent state → contact terminal 10/8 (24/22) closed, 10/9 (24/23) open (ADW 535HDx under voltage; no fault event present).

### 2.2.19 Event memory

The ADW 535HDx has an event memory capable of storing up to 1,000 events. The latest (i.e. most recent) event is always placed in the first position. If the memory exceeds 1,000 events, the oldest event is deleted. The event memory as a whole can be deleted only by the manufacturer. The event memory can be read out directly on the ADW 535HDx with **EasyConfig** (switch position **E** = last 99 events, see Sec. 8.5.4) or with the “ADW Config” configuration software (up to 1,000 events can be selected).

### 2.2.20 Data logging on the SD memory card

**Measurement values:** All relevant measurement values are written to the SD memory card every second (default, can be changed with “ADW Config”) for each sensing tube and saved in **Log-Files** (\*.xls file). After 28,800 entries (corresponding to 8 hours with an SD memory card interval of 1 s) a new **Log-File** is automatically generated. A total of 200 **log files** (L000.xls to L199.xls) can be generated for long-term logging. After the last **log file** the oldest one (L000.xls) is overwritten. The 200 **Log-Files** are sufficient to cover 66 days of data logging (with SD memory card interval of 1 s). The **log files** can be opened in Excel and the data processed with the diagram assistant to create charts.

**Events:** All events that occur in the ADW 535HDx are written to the **Event-Files** (\*.lev file). After 64,000 events a new **Event-File** is created automatically. A total of 10 **Event-Files** (E000.lev to E009.lev) can be generated for long-term logging. After the last **Event-File** the oldest one (E000.lev) is overwritten. The 10 **Event-Files** are sufficient to log over 64,000 events. The **Event-Files** can be opened with a text editor. Please refer to Sec. 8.5.4 for the interpretation of the events. There is also the possibility of importing **Event-Files** using the “ADW Config” configuration software and displaying them as real event text.

### 2.2.21 Reset types

All events triggered on the ADW 535HDx go into latching mode whenever the default configurations are used. To reset, carry out a state reset.

The following reset types are possible (see Sec. 2.2.21.1 to 2.2.21.3).

### 2.2.21.1 State reset

A state reset is triggered via **EasyConfig** switch position **R (R00)** or by actuating the “Reset external” input (see also Sec. 6.5.2). The state reset can be triggered only after an event, and only if the criterion that resulted in the event trigger is back in the normal state (e.g. Diff pressure in the smoke sensor is again below the trigger threshold or a fault event is rectified).

### 2.2.21.2 Hardware reset

A hardware reset is triggered if there is a brief interruption of the voltage supply or if the “Reset” button is pressed on the LMB 35 (see **Fig. 31** and **Fig. 35**). This restarts the ADW 535HDx. The previously programmed parameters of the ADW 535HDx are retained (system-specific configurations).



#### Notice

##### Attention: fire incident control, remote alerting!!

A hardware reset briefly triggers the fault relay (approx. 1 s). So before maintenance work is carried out on the ADW 535HDx, it is essential to switch off the fire incident controls and remote alerting on superordinate systems (FACP).

### 2.2.21.3 Initial reset

An initial reset is triggered according to the information in Sec. 7.3.5.

The initial reset procedure consists of four parts:

**Starting position with pressure equalisation.** In the first part the step motor travels to the defined starting position and remains there (pressure pump is fully wound). In this position the sensing tube screw-junction piece for the outside pressure equalisation on the evaluation unit is to be opened for about 60 s and then firmly closed (with fork wrench). To **continue** the initial reset, press the **“OK” key** on the LMB 35. **Important:** The sensing tube must be **completely vented**. If overpressure of underpressure is still present, the initial reset cannot be continued.

**Initial reset pressure.** The step motor is re-started to determine the initial reset pressure. The resulting values are saved as basic data (nominal value).

**Leakage analysis and length check;** based on the initial reset pressure and the known sensing tube length (set via **EasyConfig** or “ADW Config”), a plausibility check of the effective, connected sensing tube is performed. An initial reset fault is triggered if there is a negative length check.

**Sealing check;** here, first the pressure in the sensing tube is measured (no overpressure/underpressure) over a defined time period with reference to temperature changes. Afterwards, a sealing check of the connected sensing tube is carried out by generating pressure with the LSU 35 supervising unit and then monitoring for a certain period of time. If leakage is detected, the initial reset procedure is interrupted and an initial reset fault is triggered. The leakage must then be located by means of a sealing check as described in Sec. 5.4.2.5 (mini-compressor) and rectified.

The basic data of the initial reset pressure (nominal value) remains stored until another initial reset is carried out. An initial reset does not discard the previously defined installation-specific parameters (response grade).



#### Notices

- When commissioning and after changes to the sensing tube (length, repairs), **it is mandatory** to carry out an initial reset with the ADW housing open. An initial reset must also be carried out after repair work on the ADW 535HDx (replacement of the LSU 35 supervising unit, LMB 35 main board).
- The initial reset must always be performed under the system’s “normal conditions”, i.e. if possible, under the normal operating temperature of the sensing tube (see also Sec. 4.7.3).
- After a FW upgrade, an initial reset is required only if expressly mentioned in the relevant firmware description.
- When carrying out an initial reset, make sure the sensing tube has been correctly installed (sealed connecting points, no crushings, etc.).
- On an ADW 535-2HDx the initial reset must be performed for both sensing tubes.

### 2.2.22 ADW networking

An ADW network can be implemented by using the SIM 35 and SMM 535 additional modules via an RS485 interface. An ADW network can also be implemented via the Ethernet interface directly from the ADW 535HDx (LMB 35). Please refer to Sec. 11.2 for more information.



#### Notices

- The normative alarm transmission of the ADW 535HDx to the superordinate centre does not take place via the ADW network. For that purpose the “Alarm” / “Fault” relays in the ADW or the SecuriFire / Integral addressable loop are to be used from the XLM 35.
- The ADW network cannot be combined with the ASD network.

### 2.2.23 Heating the evaluation unit below –20°C ambient temperature

When using an ADW **below –20°C**, the internal heating of the evaluation unit automatically becomes effective. The heating ensures that the temperature inside the evaluation unit does not drop below the minimum permitted temperature of individual electronic components. Heating is by means of the actuated internal coils in the step motor of the LSU 35 of sensing tube I and the resulting heat development. The step motor itself does not run during this procedure. The heating is switched on when the temperature drops below –20°C; as soon as the temperature rises to –15°C inside the evaluation unit it is switched off again. If a test procedure should take place during the heating procedure, the test procedure has priority, i.e. the step motor begins to run “normally”.

### 3 Design

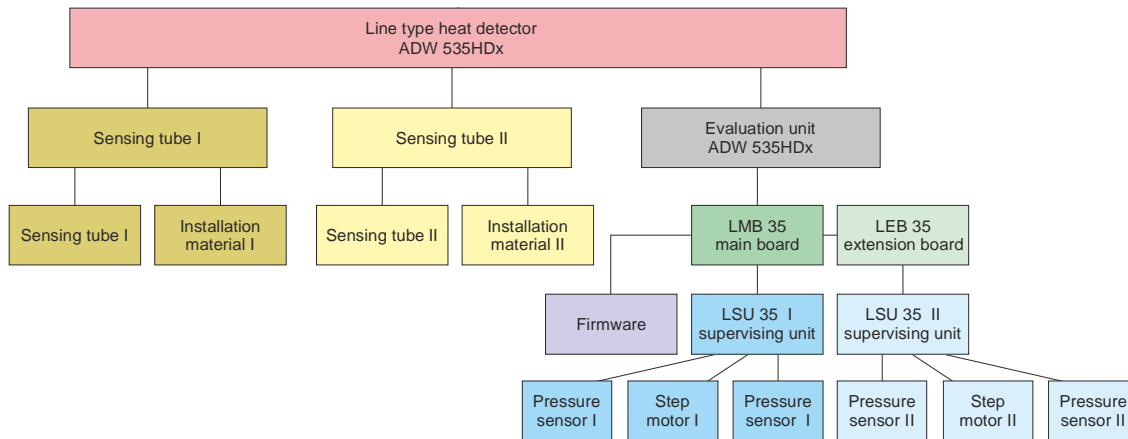

Fig. 4 ADW 535HDx design

#### 3.1 Mechanical

The ADW 535HDx line type heat detector consists of the evaluation unit and one or two sensing tubes.

The sensing tube includes the associated installation material, such as screw-junction pieces, pipe clamps and flexible hose. The sensing tube is connected to the evaluation unit and to screw-junction piece I or II.

The sensing tube is normally copper. The outer diameter is 5 mm, the inner diameter is 4 mm. The supply line to the detection zone (ceiling, detection area) can be designed with flexible hose if necessary (see also Sec. 5.3). In special applications (e.g. in an extremely corrosive and aggressive environment) other pipe materials may be used subject to the specifications in Sec. 5.3 (stainless steel, Teflon).

The evaluation unit consists of housing base and housing cover. The housing cover is fitted with four captive screws. In the housing base the LSU 35 supervising unit for sensing tube I and II is fastened by means of two screws (base) and the sensing tube connection (top side wall). The LMB 35 main board is attached on five supports via the supervising units. On an ADW with two sensing tubes the required extension board is attached on the LTHD main board and electrically connected with the connection plug.

Optional additional modules (XLM 35, RIM 36, SIM 35) can be fitted in four slots in the evaluation unit.

The events are indicated with LEDs on the LMB 35 main board and made visible by fibre optic rods on the surface of the housing. Depending on the device version, different displays are present:

- ADW 535-1HDx                    Operation, fault I, alarm I, pre-signal I.
- ADW 535-2HDx                Additionally: Fault II, alarm II, pre-signal II.

The ADW 535 / ADW 535HDx line type heat detector is available in four versions:

In thermoplastic housing for normal applications (standard, see T 140 358):

- ADW 535-1 for 1 sensing tube, 2 relays/OCs
- ADW 535-2 for 2 sensing tubes, 4 relays/OCs

In the housing for extreme ambient conditions and Ex applications → current version:

- ADW 535-1HDx for 1 sensing tube, 2 relays/OCs
- ADW 535-2HDx for 2 sensing tubes, 4 relays/OCs

**Notice**

Additional modules XLM 35, RIM 36 and SIM 35 are optionally available and are built into the ADW 535HDx when setting up the system. A maximum of four modules can be fitted.

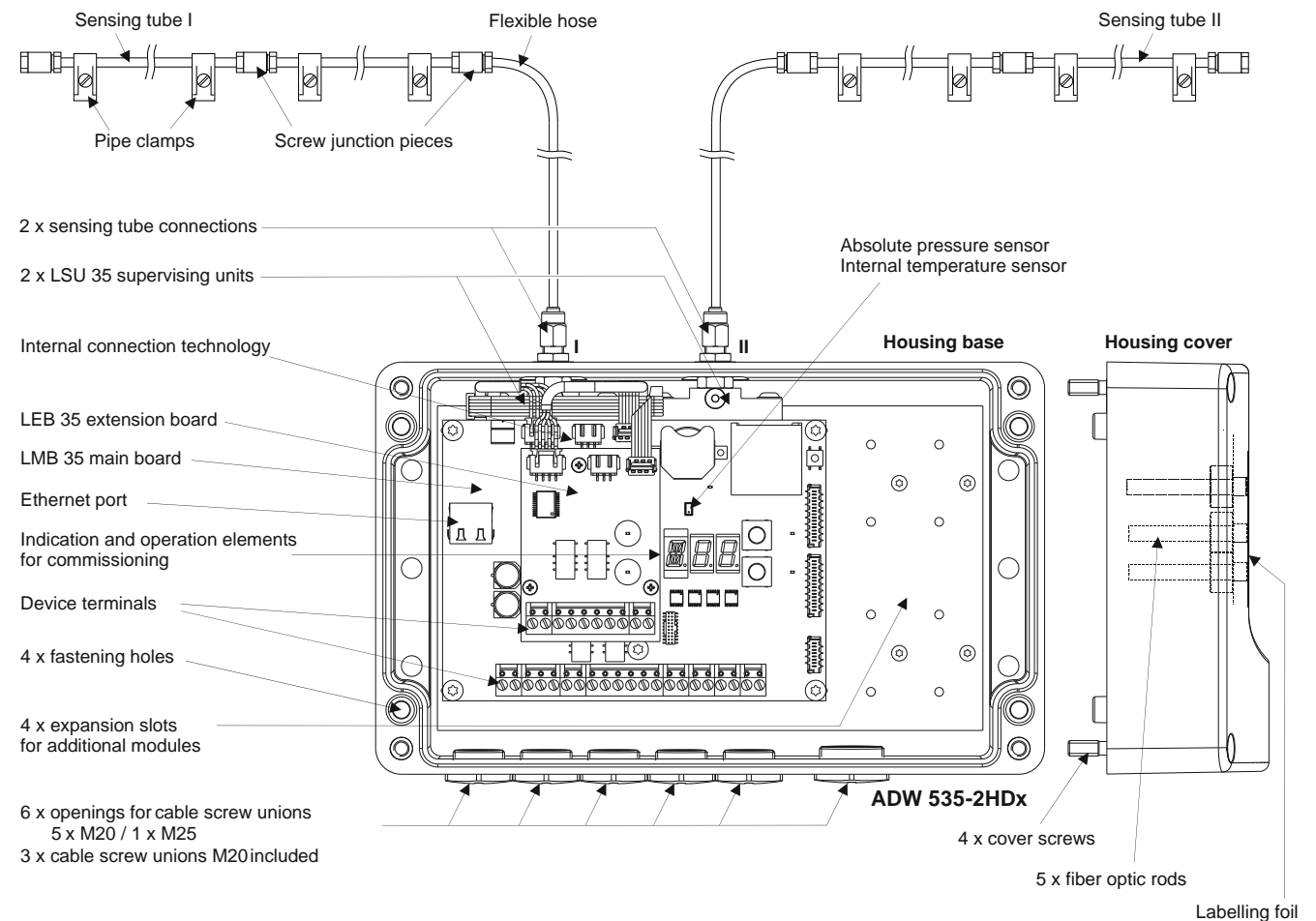

Fig. 5 Mechanical design

### 3.2 Electrical

The electrical design of the ASW 535HDx includes the following (may vary depending on the device version):

- LMB 35 main board
- LEB 35 extension board (for ADW 535-2HDx)
- LSU 35 supervising unit (2 x for ADW 535-2HDx)
- Additional modules XLM 35, RIM 36, SIM 35.

The following circuit parts and elements are on the **LMB 35** main board:

- Power supply unit with switching controller
- Output stage to activate step motor I
- Input/output stage of pressure sensor I
- Input stage of external temperature sensor I
- Output stage of valve I (not used)
- Evaluation of pressure sensor signals I and II
- Evaluation of external temperature sensors I and II
- 2 opto-isolator inputs ([InPrg1](#) and [InPrg2](#))
- Opto-isolator input for external reset
- Driver modules for actuating the relays and open collector outputs of sensing tube I
- Two relays with potential-free change-over contacts for fault I, alarm I
- Microcontroller with ports, RAM, [Flash](#) PROM, EEPROM, etc.
- Switch to write to SD memory card
- SD memory card holder
- Lithium battery
- RTC clock component
- Two buttons ([UP](#) / OK), one alphanumeric and two 7-segment displays for configuration settings
- Terminal blocks with pluggable screw terminals for the device connection
- Ethernet interface and plug
- 4 LEDs for fault I, alarm I, fault II, alarm II
- Various control LEDs
- 26-pin plug for connection to the LEB 35 extension board
- Two 16-pin ribbon cable connectors ([Option1](#) and [Option2](#)) for connecting the XLM 35 and SIM 35
- One 8-pin ribbon cable connector ([Option3](#)) for connecting to two RIM 36 units (cascaded)
- One 4-pin ribbon cable connector for connecting to step motor I
- One 6-pin connector for connecting the pressure sensor I
- One 3-pin connector for connecting valve I (not used)
- Reset button (HW reset).

The following circuit parts and elements are on the **LEB 35** extension board:

- Output step to activate step motor II
- Input/output stage of pressure sensor II
- Input stage of external temperature sensor II
- Output stage of valve II (not used)
- Driver modules for actuating the relays and open collector outputs of sensing tube II
- Two relays with potential-free change-over contacts for fault II, alarm II
- Terminal blocks with pluggable screw terminals OC-out II / relay II / ext. TempSens II
- 26-pin plug for connection to the LMB 35 main board
- One 4-pin ribbon cable connector for connection to step motor II
- One 6-pin plug for connecting the pressure sensor II
- One 3-pin plug for connecting valve II (not used)

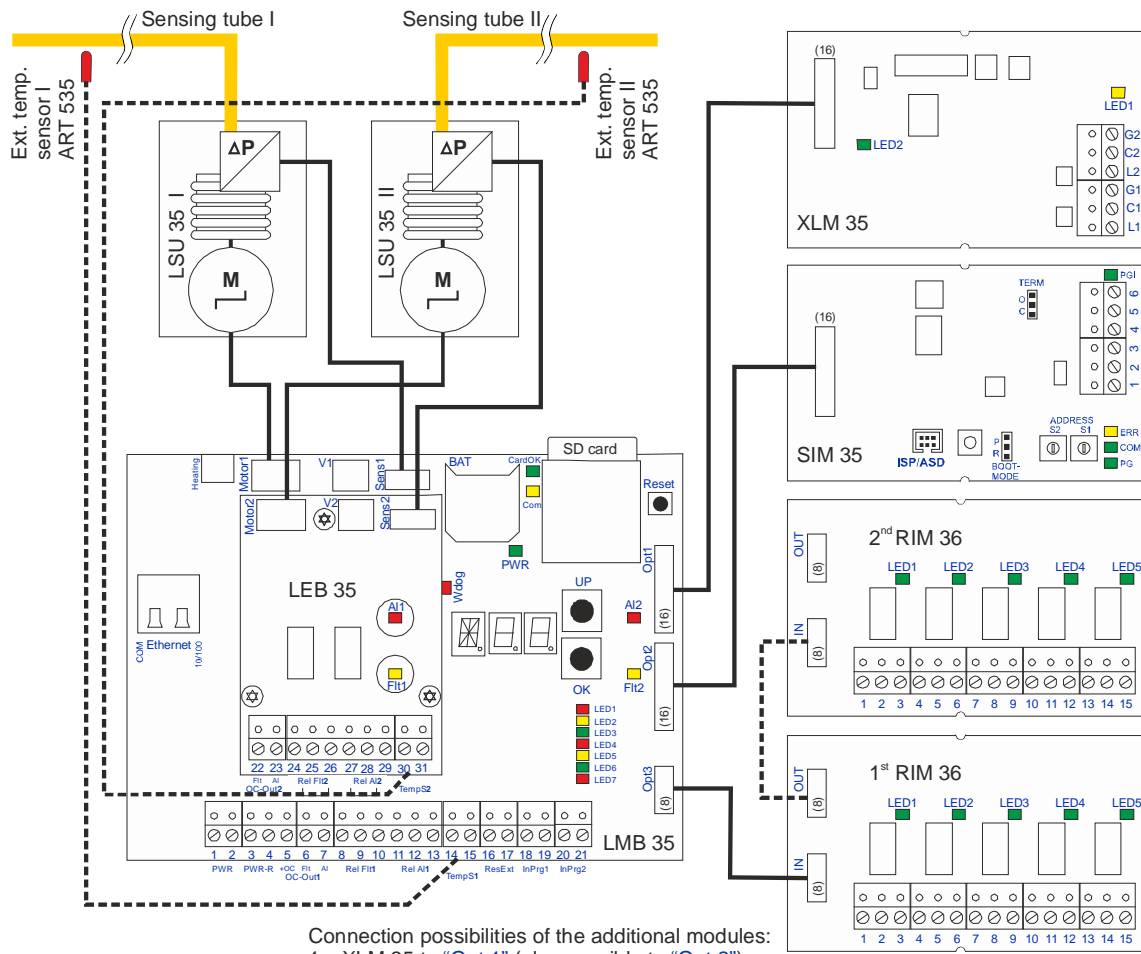

Connection possibilities of the additional modules:  
 1 x XLM 35 to "Opt 1" (also possible to "Opt 2")  
 1 x SIM 35 to "Opt 2" (also possible to "Opt 1")  
 2 x RIM 36 to "Opt 3", cascaded

Fig. 6 Electrical design

### 3.3 Hardware / firmware

The hardware is considered to comprise the complete evaluation unit and all units belonging to the ADW 535HDx line type heat detector, such as sensing tube and mounting material.

The firmware is stored on the Flash PROM in the ADW 535HDx. An EEPROM is fitted for storing and saving system-specific parameters.

!

Notices

- The ADW 535HDx is to be operated only with the appropriate original firmware from the manufacturer. Any unauthorised intervention in the firmware or the use of non-original firmware may result in malfunction and/or in damage to the device. Furthermore, all guarantee and warranty rights with respect to the manufacturer of the ADW 535HDx will become null and void as a result.
- We recommend always using the most recent SW version. In the event of changes by the manufacturer to the hardware or software of a product, there is no guaranteed update for existing systems.

## 3.4 List of materials / components

Depending on the device version, the following materials are included with the ADW 535HDx on **delivery** (see also Sec. 5.1, 5.3, 9.5.1 and 12):

	LMB 35	LEB 35	LSU 35	Commissioning protocol	Ext. Temp. sensor ART 535	XLM / RIM / SIM
ADW 535-1HDx	Yes	--	1 x	Yes	-- (accessories)	-- (accessories)
ADW 535-2HDx	Yes	Yes	2 x	Yes	-- (accessories)	-- (accessories)

The mounting set for all versions includes:  
3 cable screw unions M20 ATEX, 3x company signs, 1x (2x) clamping ring 5 mm, 1x (2x) support sleeve, 1x (2x) 4 labels for sensing tube (specifications for ADW 535-2HDx)

Depending on the version of the device, the following **accessory materials** are available:

	Ext. temperature sensor, ART 535	RIM 36	XLM 35	SIM 35
ADW 535-1HDx	1 x possible	2 x possible	1 x possible	1 x possible
ADW 535-2HDx	2 x possible	2 x possible	1 x possible	1 x possible

The **material for the sensing tube** must be separately purchased in the required quantities from the manufacturer for the specific size and deployment of the system. This material is detailed in a separate document, **T 140 362** (see Sec. 5.3, 9.5.1 and 12).



### Notice

The material for the sensing tube is a component of the device approval (e.g. VdS). Only the materials listed and approved by the manufacturer may be used when setting up the system (see T 140 362). Materials from other sources may be used only if the manufacturer's written consent has been obtained.

A special **tool** is required for mounting and handling the ADW 535HDx (Torx screws). Please refer to the list in Sec. 5.1.

## 3.5 Packaging

The evaluation unit is delivered in a suitable telescopic cardboard box sealed with adhesive tape. The packaging is recyclable and can be reused.

The mounting set and installation material sundries are packed in recyclable bags. The sensing tube is supplied in sections (copper, each approx. 5.5 m; stainless steel, each approx. 6 m), depending on the quantity of wooden crates ordered for up to 500 m, 1000 m or 2000 m sensing tubes. The Teflon sensing tube is delivered in 100 m rolls. The flexible tube is also delivered in rolls of the ordered length.

The contents of the packaging is specified as described in Sec. 1.5.



### Notices

- Electronic components such as printed circuit boards are supplied in antistatic protective packaging. These components should be removed from the packaging just shortly before use or mounting.
- Only devices with unbroken or unopened seals (adhesive tape seal) are considered new. Packaging should not be opened until immediately before use.
- The cardboard packaging of the evaluation unit meets the minimum requirement for packaging and can be stacked up to 10 times its weight.
- The packaging of the ADW 535HDx is suitable only to a limited extent for shipment by post or railway.
- For transport in or to tropical regions, marine transport, etc., the appropriate measures must be taken (special packaging as provided by the shipper).

## 4 Planning

### 4.1 General aspects of planning

#### 4.1.1 Standards, regulations, guidelines, approvals

Section 4 “Planning” provides guidelines for planning the ADW 535HDx line type heat detector. These guidelines address the direct application only insofar as it applies to compliance with the relevant standard and is required to ensure technically trouble-free operation.



#### Notices

- The use of special fire alarm systems such as the ADW 535HDx is subject in some cases to country-specific regulations and guidelines and must therefore be approved by the relevant technical bodies and authorities (insurance companies) prior to implementation.
- For many uses that are country, facility and application specific there are planning guidelines, application examples and applicable regulations and directives. These documents can be requested from the manufacturer of the ADW 535HDx system or from the responsible technical bodies and authorities.
- The country-specific regulations and guidelines apply as a matter of principle to the intended use, planning and application of the ADW 535HDx line type heat detector. In any case the country-specific specifications always take precedence over the planning specifications outlined below.

The ADW 535HDx line type heat detector complies with the requirements **EN 54-22**, **FM 3210** and **UL 521/ULC-S530-M91**.

The response behaviour of the ADW 535HDx is tested in compliance with:

- **EN 54-22** = classes **A11** to **GI**;
- **UL 521 – ULC-S530-M91** = according EN 54-22, classes **A11** to **GI**.
- **FM 3210 / NFPA 72** = classes **Ordinary**, **Intermediate**, **High** – Spacings 15 ft / 20 ft / 25 ft / 30 ft / 40 ft;
- **RVS** = in accordance with the requirements for road tunnels (AT);
- **KFI** = in accordance with the requirements for road tunnels (KR).

This operating material complies with the requirements of EN 60079-0, EN 60079-7, EN 60079-15, EN 60079-31 and EC Directive “Equipment and protective systems intended for use in potentially explosive atmospheres” (2014/34/EU) and “Electromagnetic compatibility” (2014/30/EU). It was developed, manufactured and tested based on the latest technical standards and in compliance with ISO 9001.

This operating material is suitable for use in potentially explosive atmospheres of **zone 2** and **zone 22** in compliance with VDE 0165 and IEC 60079-10.



#### Use in potentially explosive atmospheres

- This operating material (evaluation unit) is not permitted to be used in potentially explosive atmospheres of zones 0, 20, 1 and 21!
- Observe the technical data specified on this operating material!
- Conversions and modifications to this operating material are not permitted!

### 4.2 Applications

Thanks to the product's excellent properties under severe ambient conditions, the ADW 535HDx is used wherever problems are to be expected owing to latent disturbance variables during operation such that optimal protection can no longer be guaranteed with conventional point detectors. Thanks to its self-check feature and the periodic, automatic test, the ADW 535HDx is particularly suitable for use in applications where the legally prescribed functional and maintenance checks cannot be performed. Typical applications of the ADW 535HDx include the following:

- Ex zones 2 and 22 acc. to VDE 0165 and IEC 60079-10;
- Paint spray and paint shops, tank storage, chemical industry, underground mining (see also Sec. 4.9);
- Road tunnels, railway and underground railway tunnels in extreme ambient conditions;
- Loading platforms, car park halls, car decks on ships, in extreme environmental conditions.

**EN 54-22:** The type of application determines the response grade selection according to EN 54-22 as follows:

- Space surveillance Cl. **A1I, A2I** → Heat impingement of **10 m**;
- Equipment monitoring Cl. **BI to GI** → Heat impingement of the **entire length** in the monitored area.

**NFPA 72 / RVS / KFI:** For these applications, refer to the specifications in Sec. 4.7.1 and 4.7.2.

### 4.3 Area of application

To comply with a required system configuration, the ADW 535HDx can be connected via its potential-free change-over contacts or by using control-panel-specific line modules (e.g. XLM 35) to all common fire alarm systems virtually without restrictions.



#### Use in potentially explosive atmospheres

When using the ADW 535HDx in potentially explosive atmospheres, **only** the **RIM 36**, **XLM 35** and **SIM 35** additional modules may be installed in the ADW. The installation of other modules such as the **BX-OI3** or **line modules from external FACPs** is **not permitted**. Such modules may only be installed in separate Ex-approved map cases and are the personal responsibility of the supplier or user of the modules (see also Sec. 6.5).

The receiver modules (opposite side) of the XLM 35 and SIM 35 additional modules must be positioned outside of the Ex-zone in the safe area.

## 4.4 Planning aids

### 4.4.1 Planning with “ADW HeatCalc” calculation

The “ADW HeatCalc” calculation software is used for planning the sensor tubing. It is used for designing the required pipe entities on a drawing in order to realise a system. The “ADW HeatCalc” calculation software provides a varied selection of tube materials, fittings and accessory parts (detection coil, test coil, etc.). The end result of the software calculation specifies triggering whose parameters comply with **EN 54-22 / NFPA 72 / RVS / KFI**; the ADW 535HDx will then be programmed with these parameters. For response-class-related use of the ADW 535HDx, the specifications in Sec. 4.1.1 must be observed.

The material stored in the “ADW HeatCalc” calculation software for the sensing tube as well as the “ADW HeatCalc” calculation software itself are components of the device approval (e.g. VdS). A list of the available materials for the sensing tube is provided in a separate document (T 140 362).

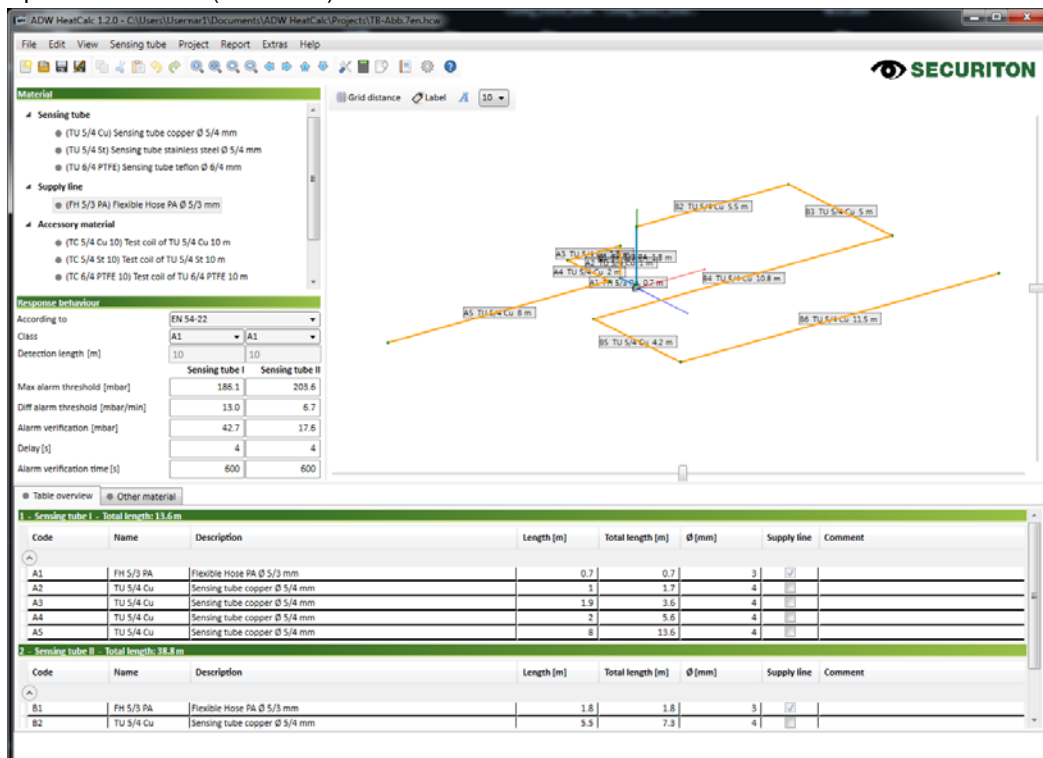

Fig. 7 “ADW HeatCalc” programming interface

### 4.4.2 Planning without “ADW HeatCalc” calculation

If planning work is performed without “ADW HeatCalc”, the ADW 535HDx provides a number of switch positions which have been stored with predefined values required for a trigger in accordance with **EN 54-22 / NFPA 72 / RVS / KFI** (see also Sec. 4.5.1.1). For response-class-related use of the ADW 535HDx, the specifications in Sec. 4.1.1 must be observed.



#### Notices: Planning without “ADW HeatCalc” calculation

- The maximum tube lengths specified in Sec. 4.5.1.1 may not be exceeded.
- Only **copper** and **stainless-steel** tubing and their screw-junction pieces (including flexible hose for lines) may be used as listed in document T 140 362.
- **Teflon** may be used **only with “ADW HeatCalc” calculation**.
- If other tube and accessory parts are to be used (e.g. detection coils, test coils, T-pieces in the sensing tube, etc.), it is essential that you use the “ADW HeatCalc” calculation software.

### 4.5 General information about system limits

When using an ADW 535HDx line type heat detector, the system limits below apply and ensure compliance to EN 54-22 / NFPA 72 / RVS / KFI requirements.

Sensing tube material	Length of the sensing tube per evaluation channel ① (Fig. 8 “B”)				outside standard ①
	EN 54-22 A11 to GI	NFPA 72 NO / NI / NH	RVS tunnel	KFI tunnel	
Copper / stainless steel	10 – 115 m	10 – 200 m	10 – 200 m	10 – 115 m	10 – 200 m ①
Teflon ①	10 – 105 m ①	10 – 150 m ①	10 – 150 m ①	10 – 105 m ①	10 – 150 m ①

① For applications under less than 15 m, outside a specified standard, and with a Teflon sensing tube the “ADW HeatCalc” calculation software must always be used. The calculated trigger thresholds are written with the “ADW Config” calculation software to switch positions **X01** to **X03**.

#### 4.5.1 System limits without “ADW HeatCalc” calculation

The system limits detailed in Sec. 4.5.1.1 apply to planning without the “ADW HeatCalc” calculation software. The system limits are switch positions (**EasyConfig**) stored with predefined values for the **alarm release** compliant with the relevant standard / guideline (switch positions **C > A1** to **T3**). For response-class-related use of the ADW 535HDx, the specifications in Sec. 4.1.1 must be observed.

In terms of applications in accordance to **EN 54-22**, in the event of pipe breakage in the sensing tube a **fault trigger** must occur within **300 s**. This requirement is met by the ADW 535HDx in switch positions **C > A1** to **G**.

For applications in severe environments with **increased disturbance variables** the sensing tube monitoring can be disarmed. For that purpose, in addition to switch positions **C > A1** to **T3**, switch positions **W01** to **W09** are also used.

**Notice to W04 to W09**

**Important:** Concerning sensing tube monitoring, switch positions **W04** to **W09** react **outside** the prescribed times according to **EN 54-22** and therefore may be used only after consulting with the manufacturer → see also Sec. 4.5.1.2.

Fig. 8 below illustrates the sensing tube design and tube length specifications. Maximum tube length is found in the table in Sec. 4.5.1.1

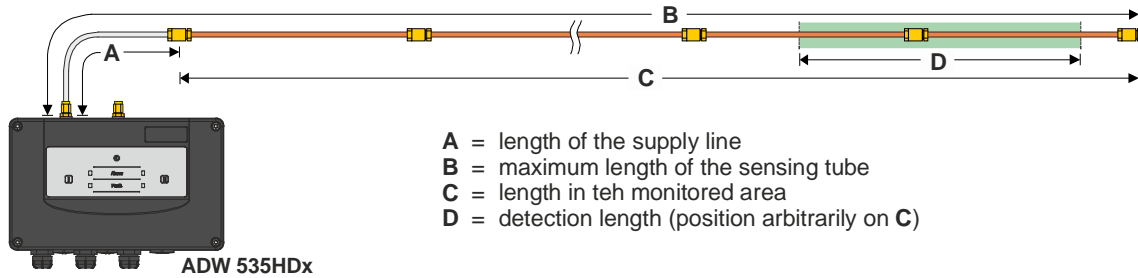

Fig. 8 Definitions of sensing tube lengths

4.5.1.1 Normative system limits without “ADW HeatCalc” calculation

Switch positions **C > A1 to T3** have configured values necessary for alarm response sensitivity and sensing tube monitoring in compliance with the relevant standards or guidelines:

- **A1 to G:** response behaviour acc. to **EN 54-22**, classes **A11 – G1** ①;
- **No, NI, NH:** response behaviour acc. to **NFPA 72**, classes **Ordinary, Intermediate, High**, every 30 ft **Spacing** (9,1 m);
- **T1:** Tunnel application, response behaviour acc. to **RVS** (AT);
- **T2:** Tunnel application, response behaviour acc. to **KFI** (KR);
- **T3:** Only for laboratory tests, response behaviour acc. to **KFI** (KR), “**Class A**”.

Switch position: <b>C &gt; A1 to T3</b>	Switch position (additional), <b>W04 to W09</b> Not standards compliant for <b>EN 54-22</b>	Application	Diff alarm			Max alarm threshold ⑥ (mbar)	AI delay (s)	Length of the supply line (ADW to monit. area) ⑦ (Fig. 8 “A”)	Max. length of sensing tube (ADW to tube end) ③ / ⑥ (Fig. 8 “B”)	
			Diff alarm threshold ⑥ (mbar/min)	Delta pressure ⑥ (mbar)	Time (s)					
① / ② / ③ Standard / guideline	C >	⑤								
EN 54-22	<b>A1</b>	<b>C &gt; W01 – W03</b>	R	2.3	6.1	600	210.9	4	5 m	115 m
	<b>A2</b>	<b>C &gt; W01 – W03</b>	R	2.3	8.2	600	220.4	4	5 m	115 m
	<b>A1– ①</b>	<b>C &gt; W01 – W03</b>	R	5.1	7.9	600	210.9	4	5 m	115 m
	<b>A2– ①</b>	<b>C &gt; W01 – W03</b>	R	5.1	10.6	600	220.4	4	5 m	115 m
	<b>b</b>	<b>C &gt; W01 – W03</b>	E	2.3	8.2	600	273.2	4	5 m	115 m
	<b>C ②</b>	<b>C &gt; W01 – W03</b>	E	2.3	8.2	600	326.8	4	5 m	115 m
	<b>d ②</b>	<b>C &gt; W01 – W03</b>	E	2.3	8.2	600	380.5	4	5 m	115 m
	<b>E ②</b>	<b>C &gt; W01 – W03</b>	E	2.3	8.2	600	433.2	4	5 m	115 m
	<b>F ②</b>	<b>C &gt; W01 – W03</b>	E	2.3	8.2	600	486.9	4	5 m	115 m
<b>G ②</b>	<b>C &gt; W01 – W03</b>	E	2.3	8.2	600	540.6	4	5 m	115 m	
NFPA 72	<b>No</b>	<b>C &gt; W01 – W09</b>	N	3.9	2.6	300	267.6	4	5 m	200 m
	<b>NI</b>	<b>C &gt; W01 – W09</b>	N	5.4	3.2	300	362.1	4	5 m	200 m
	<b>NH</b>	<b>C &gt; W01 – W09</b>	N	6.8	3.9	300	510.5	4	5 m	200 m
RVS KFI KFI (Lab)	<b>T1</b>	<b>C &gt; W01 – W09</b>	T	3.0	2.0	600	214.7	4	5 m	200 m
	<b>T2</b>	<b>C &gt; W01 – W09</b>	T	8.7	1.7	600	210.9	4	5 m	115 m
	<b>T3</b>	<b>C &gt; W01 – W09</b>	--	3.0	1.5	600	215.8	3	0 m	100 m

Notice about the table:

- ① Switch positions **A1–** and **A2–** are oriented to Classes A11 and A21 for space surveillance compliant with EN 54-22 but have no detection properties for test fire TF6 **slow**. If slowly developing fires are **not** to be taken into consideration in an application. These switch positions can be used **after consulting with the manufacturer**. **Caution:** These switch positions may **not be used for the comprehensive requirements of EN 54-22**.
- ② For response-class-related use of the ADW 535HDx, the information in the Sec. 4.1.1 must be observed. In classes **CI to GI** the ART 535 external temperature sensor must always be used for temperature compensation (see also Sec. 2.2.12 and 6.5.6).
- ③ Programming sensing tube lengths **greater than 115 m** is possible only in switch positions **No, NI, NH** and **T1**.
- ④ Switch positions **W04 to W09** may be used only after consulting with the manufacturer. The configured values they contain concerning sensing tube monitoring are **not** tested in accordance with EN (see Sec. 4.5.1.2).
- ⑤ **R = space surveillance** = acc. to **EN 54-22** → 10 m heat impingement.  
**E = equipment monitoring** = acc. to **EN 54-22** → heat impingement of the **entire length** in the monitored area (crucial only for the Max alarm).  
**N = space surveillance** = acc. to **NFPA 72** → 30 ft (9.1 m) heat impingement.  
**T = tunnel surveillance** = acc. to **RVS/KFI** → heat impingement of a partial length, dependent on the airflow in the object.
- ⑥ The values for **Diff alarm**, **Max alarm** and **delta pressure** specified in the table above are valid only for a version of the sensing tube that is 115 m or 200 m in length (see also Sec. 2.2.10 and 2.2.11). With the programming of the project-specific length of the sensing tube in the setting procedure (**EasyConfig** submenu **L01 / L02 > 015 to 115** or to **200** in the concerned switch position **C**) the values are converted accordingly and configured in the ADW.
- ⑦ The length of the **supply line** must be observed as specified above. Deviations of ± 10% are permitted.



Notice

When operating the **Teflon sensing tube**, the “ADW HeatCalc” software must be used to determine alarm thresholds.

## Planning

### 4.5.1.2 Non-normative system limits without “ADW HeatCalc” calculation (sensing tube monitoring)

Switch positions **W04** to **W09** contain **non-normative system limits** concerning **sensing tube monitoring**. The alarm response sensitivity compliant with EN 54-22, classes A1I to GI is not influenced but rather corresponds to the settings of the additionally set **EasyConfig** switch positions **C > A1** to **G**. For response-class-related use of the ADW 535HDx, the specifications in Sec. 4.1.1 must be observed.

The following table shows the parameters of switch positions **W04** to **W09** that do not conform to EN 54-22 concerning sensing tube monitoring. The settings always apply to **both** sensing tubes **together**.

Alarm release compliant with EN 54-22:		Sensing tube monitoring:							Switch position
↓	corresponds to position	Remarks	Monitoring acc. to EN 54-22	Cyclical Test	Sensitivity ①	Interval	Repetition rate	Waiting time	
A1I A2I BI CI DI EI FI GI	A1 A2	Normative	On	On	Medium	24 h	2 x until fault	30 min	<b>W00</b> ②
		Normative	On	On	Low	24 h	4 x until fault	30 min	<b>W01</b>
		Normative	On	On	High	24 h	4 x until fault	30 min	<b>W02</b>
	b c d e f g	Normative	On	Off	Low	---	---	---	<b>W03</b>
		Not normative	Off	On	Low	8 h	2 x until fault	30 min	<b>W04</b>
		Not normative	Off	On	Low	8 h	4 x until fault	30 min	<b>W05</b>
		Not normative	Off	On	Medium	8 h	2 x until fault	30 min	<b>W06</b>
		Not normative	Off	On	Medium	8 h	4 x until fault	30 min	<b>W07</b>
		Not normative	Off	On	High	8 h	2 x until fault	30 min	<b>W08</b>
③	Not normative	Off	On	High	8 h	4 x until fault	30 min	<b>W09</b>	



### Notices

Switch positions **W04** to **W09** may be used only after consulting with the manufacturer. The configured values they contain concerning sensing tube monitoring are **not** tested in accordance with EN

- ① See also Sec. 2.2.9.1 for more about the sensitivity levels “Low”, “Medium” and “High”.
- ② **Default** setting = **W00**. Via switch positions **W00** to **W03** the sensing tube monitoring can be subsequently switched back to **normative limits**.
- ③ Switch positions **W01** to **W09** can also be selected for response grades compliant with NFPA 72 / RVS/KFI (switch positions **No** to **T3**), but they are not relevant for compliance with the concerned standard/directive.

## 4.6 Settings

Depending on the planning process – with or without the “ADW HeatCalc” calculation software – the following setting procedure is required:

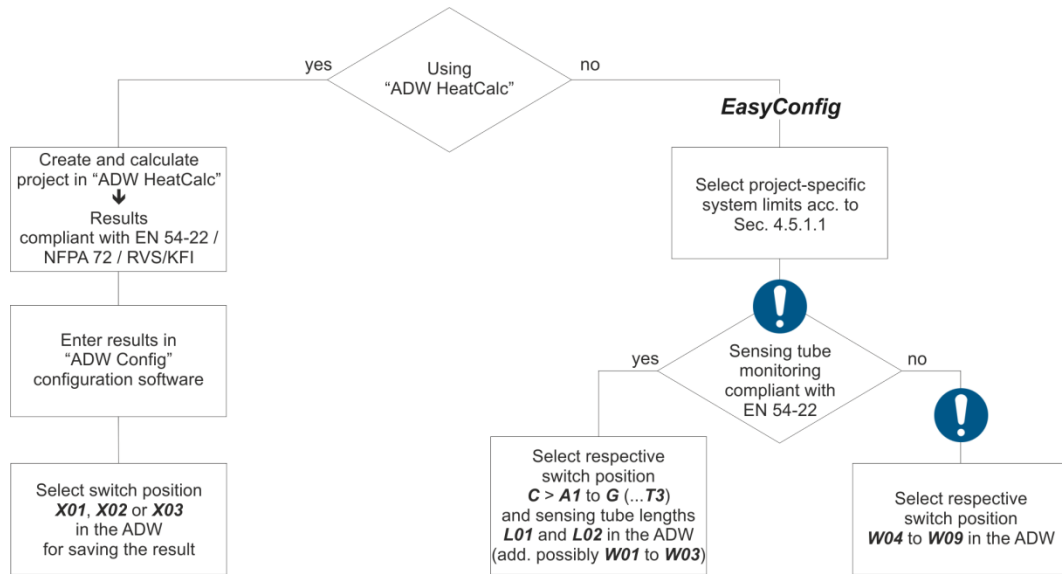

Fig. 9 Workflow for project-specific programming and adjustment

The description of the predefined positions and the operating structure is found in Sec. 4.5.1.1, 4.5.1.2, 7.2.1 and 8.3.

Depending on the use of the ADW 535HDx, it may be necessary to make adjustments to the sensing tube monitoring using the “ADW Config” configuration software. Please note and adhere to the following information:

**Notices**

- In applications in extreme environments with increased disturbance variables (e.g. tunnels) a **deviation in the sensing tube monitoring** may be necessary. **Important:** This may mean that standard EN 54-22 is no longer complied with (**W04 to W09 do not meet the requirements of EN 54-22**) and may be used only after consultation with the manufacturer. All switch positions from **W01 to W09** are not relevant for NFPA 72 / RVS/KFI response grade compliance (switch positions **No to T3**).
- Changing the configuration “**Sensing tube monitoring**” is for use under special conditions and may be implemented only after consulting with the manufacturer.
- Starting the test procedure **only from cyclical test procedure** (not from monitoring) means also non-compliance with **EN 54-22** and may be performed only after consulting with the manufacturer.

## 4.7 Monitoring area

### 4.7.1 Tunnels

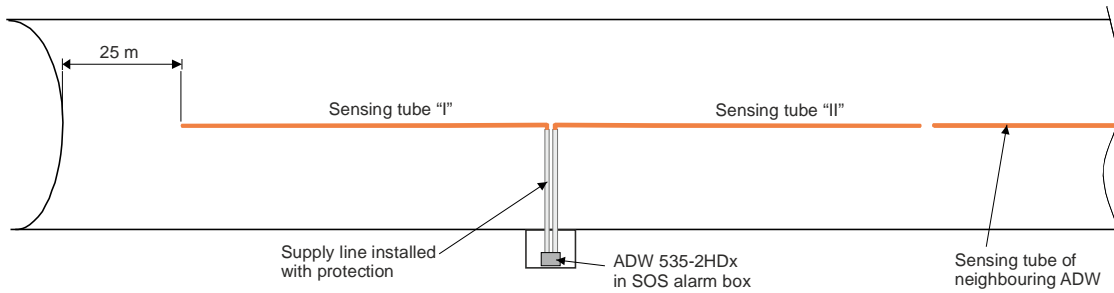

Fig. 10 ADW 535-2HDx arrangement in tunnels

#### Tunnels with arched or rounded ceilings

##### 2 to 3 traffic lanes

- Sensing tube mounting **always** in the centre of the tunnel (lateral tolerance = 0.5 m)
- **No** sensing tube mounting permitted on the side
- Applications and max. length per sensing tube  $\Phi$ :
  - **KFI** = 10 – 115 m (if Teflon = 10 – 105 m)
  - **RVS** = 10 – 200 m (if Teflon = 10 – 150 m)

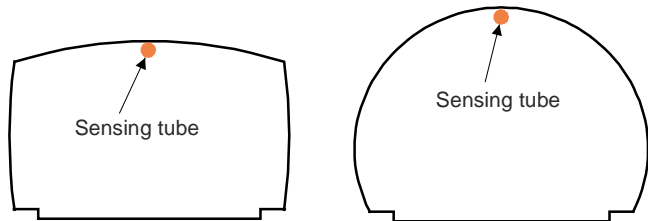

Fig. 11 Tunnel with arched, rounded ceiling

#### Tunnel with flat ceilings

##### 2 to 3 traffic lanes

- Sensing tube mounting preferably in the centre of the tunnel (lateral tolerance = 0.5 m)
- Sensing tube mounting on the side possible, distance "a":
  - for 2 traffic lanes = min. 0.5 m
  - for 3 traffic lanes = min. 1 m
- Applications and max. length per sensing tube  $\Phi$ :
  - **KFI** = 10 – 115 m (if Teflon = 10 – 105 m)
  - **RVS** = 10 – 200 m (if Teflon = 10 – 150 m)

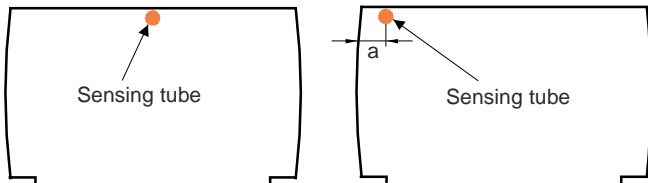

Fig. 12 Tunnel with flat ceiling

#### Tunnel with flat ceilings

##### over 3 traffic lanes

- At least 2 sensing tubes
- Sensing tube mounting distance:
  - "a" = max. 10 m
  - "b" =  $\frac{1}{2}$  "a"
- Applications and max. length per sensing tube  $\Phi$ :
  - **KFI** = 10 – 115 m (if Teflon = 10 – 105 m)
  - **RVS** = 10 – 200 m (if Teflon = 10 – 150 m)

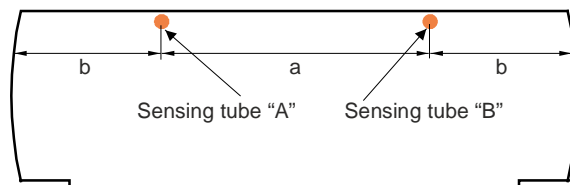

Fig. 13 Tunnels with flat ceiling, over 3 traffic lanes



### Notice

① Depending on the detection properties requirements, the maximum sensing tube length can be shorter (based on the manufacturer's specifications).

If there are **EN 54-22** or **NFPA 72** requirements in tunnels, the system limits in Sec. 4.5 must be adhered to.

It should be noted that in applications with extreme ambient conditions, a deviant response behaviour may be necessary (e.g. for a high volume of traffic, danger of traffic jam, strong ventilation). Such settings are possible only after consulting with the manufacturer.

In the portal areas of tunnels a distance of 25 m must be maintained from the end of the sensing tube to the portal.

4.7.2 Space surveillance, car park halls, car decks on ships



**Notice**

The following information about the monitoring area and sensing tube distances is based on country-specific directives and regulations for planning and installation of automatic fire alarm installation (e.g. DIN VDE 0833-2 in Germany, VKF in Switzerland, NFPA 72 in the USA).

In vehicle storage halls and similar applications the following basic principle applies:

**Surveillance acc. to DIN VDE 0833-2 (EN 54-22)**

- Sensing tube length = 10 – 115 m (if Teflon = 10 – 105 m)
- Conveyance in looping shape (serpentine) possible
- Maximum permitted distance “a” of sensing tube to sensing tube = 7.0 m
- Maximum permitted distance of sensing tube to wall “b” = ½ “a” = 3.5 m
- Provision for ceiling joists acc. to country-specific directives

**Surveillance acc. to NFPA 72**

- Sensing tube length = 10 – 200 m (if Teflon = 10 – 150 m)
- Conveyance in looping shape (serpentine) possible
- Maximum permitted “S” distances dependent on the selected Spacing:

Tube to tube “S”	Tube to wall “0.5S”	Tube to corner “0.7S”
15 ft (4,6 m)	7,5 ft (2,3 m)	10,5 ft (3,2 m)
20 ft (6,1 m)	10 ft (3,0 m)	14 ft (4,3 m)
25 ft (7,6 m)	12,5 ft (3,8 m)	17,5 ft (5,3 m)
30 ft (9,1 m)	15 ft (4,6 m)	21 ft (6,4 m)
40 ft (12,2 m)	20 ft (6,1 m)	28 ft (8,5 m)

**Car park halls example compliant with VdS 2095, VKF**

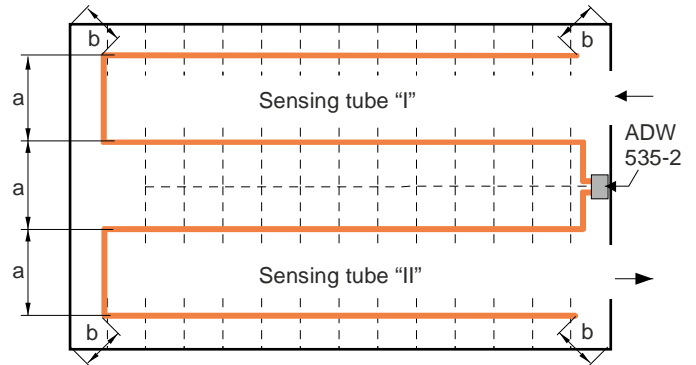

**Surveillance example compliant with NFPA 72**

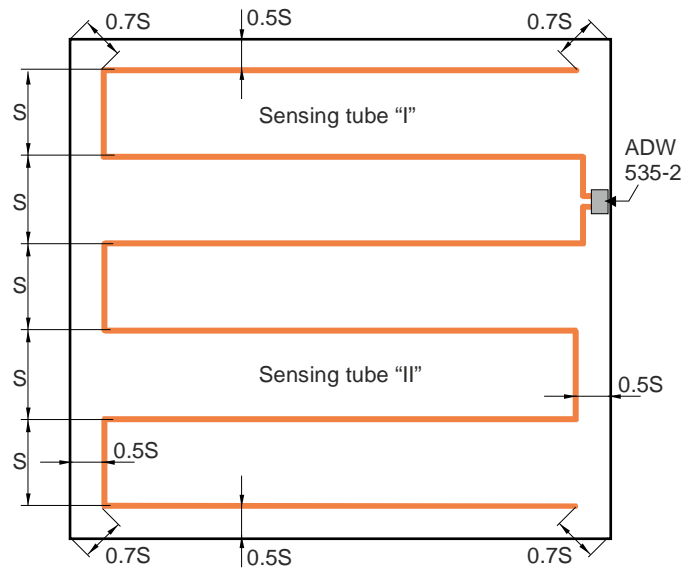

Fig. 14 Space surveillance example

### 4.7.3 Use when ambient temperature is high

Uses of the ADW 535HDx in high ambient temperature areas are defined as equipment monitoring in accordance with EN 54-22. For equipment monitoring it is assumed that in the event of a fire the **entire length** of the sensing tube is impinged with heat in the monitored area. The information in the following Notice must be strictly adhered to in high temperature areas.



#### Notices

- The **temperature specification** of the used sensing tube materials described in **Sec. 5.3** must be observed and adhered to.
- When used in an environment with high ambient temperatures, use metal pipe clamps.
- The evaluation units must be stored in an area with normal ambient temperatures.
- A supply line made of flexible tubing must be implemented between the ADW 535HDx and the high-temperature area (heat spreads via the tube to the evaluation unit).
- The transition from the flexible tubing to the sensing tube must be outside the high-temperature area.
- For the temperature compensation the external temperature sensor ART 535 is to be used and placed in the monitored area. For temperature ranges over 200°C use the ART 535-10 / 400 °C version.

For use in high ambient temperatures that exceed the application temperature of the response grades compliant with EN 54-22 (greater than 140°C), the **maximum alarm threshold** is to be set using “ADW Config” based on the following table. Also, depending on the application temperature (or triggering temperature), the minimum temperature specified in the table for the initial reset must be observed. Finally, the maximum permitted pressure range of the pressure sensor used in the ADW must not be exceeded.



#### Notice

The values listed below apply to sensing tubes with a **length ratio** of **1 to 10** (“Supply line length” to “Length in the monitored area”). The values for **other length ratios** are provided by the **manufacturer** upon request.

Trigger temperature ① (°C)	Max alarm threshold (mbar)	Minimum temp. for Initial reset (°C)	Trigger temperature ① (°C)	Max alarm threshold (mbar)	Minimum temp. for Initial reset (°C)	Trigger temperature ① (°C)	Max alarm threshold (mbar)	Minimum temp. for Initial reset (°C)
160	560	11	210	735	43	260	910	76
170	595	18	220	770	50	270	945	83
180	630	24	230	805	57	280	980	89
190	665	30	240	840	63	290	1015	96
200	700	37	250	875	70	300	1050	102

① The corresponding **maximum application temperature** is in each case **30°C under** the specified trigger temperature.



#### Notices

- The setting of the **Diff alarm** when used in high ambient temperatures should be identical with the setting of classes **BI** to **GI** (see also Sec. 4.5.1.1).
- Because the length ratio (“Supply line length” to “Length in the monitored area”) is a key factor for the **Diff alarm**, the values of the **Diff alarm** length must always be calculated with “**ADW HeatCalc**”.

#### 4.7.4 Modernising existing systems



##### Notice

When modernising existing systems, the existing sensing tubing must be re-calculated using the “ADW HeatCalc” calculation software. The existing sensing tube must be checked (inspected for damage, leakage) prior to commissioning.

#### 4.7.5 Other

For all other applications the monitoring area and sensing tube distances are determined in consultation with the point of delivery. The permissible sensing tube length is usually 115 m. Longer, application-specific lengths have to be approved by the manufacturer. For each monitored area (for multiple areas) and in object protection, a minimum sensing tube length of 10 m must be observed (heat impingement).

### 4.8 Electrical installation



#### Use in potentially explosive atmospheres

The safety regulations (according to [BetrSichV](#), IEC 60079-17) and the device safety regulations as well as the generally recognised rules and technology applicable to installing and operating electrical operating materials are to be observed.

- The sensing tube must be connected to equipotential bonding (earthing) (see also Sec. 5.3 and 5.4.2).
- Before the ADW 535HDx evaluation unit is opened, it must be ensured that it is de-energized and that appropriate protective measures are used.
- The electrical installation must be performed using cables with one-wire conductors measuring 0.5 – 2.5 mm<sup>2</sup>.
- The stripping length for connecting to the existing terminals is 6 mm.
- The terminals are to be tightened with a torque M of 0.5 Nm.
- The lines are to be conveyed through the cable and line entries!
- Three corresponding cable and line entries M20 (Ø 7–13°mm) are included. Additional ones in this size and in size M25 (Ø 11–17°mm) are optionally available.
- The M20 cable screw unions are suitable only for areas with a low risk of mechanical hazard. If necessary, these cable screw unions must be mechanically protected by suitable means (impact protection device).
- To ensure the required minimum protection type, the cable and line entries and the blind plugs must be firmly tightened! The following torques are to be used for installation in the housing and for tightening the cable entry:
  - ⇒ Cable and line entries M20 (Ø 7–13°mm) torque M of 3.8 Nm
  - ⇒ Cable and line entries M25 (Ø 11–17°mm) torque M of 5 Nm
- To protect against twisting and additional cable strain, the connection cables must be mechanically secured immediately before entering the ADW housing (e.g. with cable clamp).
- Unused cable and line entries must be sealed with the original blind plugs!
- Before the housing cover is mounted, the state and position of the seal must be checked.
- The screw plugs of the housing cover must be firmly and uniformly tightened.
- Transport and storage of this operating material are permitted only when the original packaging is used.

### 4.8.1 Installation cable requirements

The supply line from the FACP to the evaluation unit is determined by the line and FACP technology in use.

Cables with twisted pairs are to be used as a matter of principle. With 4-wire and multi-wire cables, twin- or quad-twist cables are to be used.

Laying the voltage supply line and line in parallel is permitted.

A separate wire pair is to be used for the ADW 535HDx voltage supply.

The electrical installation is usually performed with commercially available cables. Depending on the country of use, special fire detector cable may be required by the relevant authorities. The relevant country-specific authorities should therefore be consulted concerning the required cable types.

The installation cable must have a minimum wire diameter of 0.8 mm (0.5 mm<sup>2</sup>). **Please refer to Sec. 4.8.2 for determining the exact maximum cable length and the required cable cross-section.**



#### Notices

- For safety reasons (EN 54) individual cables must be used for the outbound and return lines for addressable loop technologies.
- Further, the **FACP manufacturer's specifications** concerning maximum **line length, cable type, shielding** etc. of the addressable loop technology **must be observed**.
- The order separation and installation type are also subject to country-specific guidelines and regulations.
- **Caution:** For monitoring the automatic fire detector, **no looped lines** may be connected to terminals **Alarm I, Fault I, Alarm II** or **Fault II**. The looped line must be interrupted to enable connection monitoring.
- The electrical installation of the ADW 535HDx can normally be performed without screening. The installation of the SecuriFire / Integral addressable loop on an **XLM 35** must be **shielded**. Screening of the installation is moreover required wherever EMC influences are to be expected. In the following environments disturbance variables can be expected and the installation must be provided with screening accordingly:
- In and around transmitter and radio facilities. Near high-voltage and low-voltage installations with high energy. In areas with EMC field intensities in excess of 10 V/m In cable ducts and vertical shafts together with high-energy cables In areas with high-energy devices and installations (generators, power plants, railway facilities, X-ray equipment, etc.). Outside buildings.
- If screening is used, the cable screening in the ADW 535HDx is to be connected to an additional support terminal. The cable screening must **not** be connected to the minus or **Ground** terminal of the LMB 35.



### 4.9 Restrictions



#### Notices

The following restrictions apply to the use and application of the ADW 535HDx. For other solutions, please consult the manufacturer.

- Only the materials supplied by the manufacturer may be used for setting up the system. Materials from other sources may be used only if the manufacturer's written consent has been obtained.
- The sensing tube length with the sensing tube material listed in Sec. 5.3 is not permitted to be under or over the application-relevant system limits according to Sec. 4.5 (including ascent to the ceiling). Other tube lengths mean that special sensing tubes have to be selected (see also Sec. 5.3).
- For each monitored area (for multiple areas) and in object protection, a minimum sensing tube length of 10 m must be observed (heat impingement).
- Evaluation units and sensing tubes must not be exposed to direct sunlight.
- In applications where extreme pressure impact or extreme temperature changes due to work processes may occur, the evaluation unit must be enclosed in an additional protective box (e.g. SOS alarm boxes in road tunnels). In some cases construction measures may be necessary, e.g. shielding the sensing tube in certain areas.
- If the sensing tube is being used in extremely corrosive environments, provide for sufficiently resistant tube materials (see also Sec. 5.3).
- Monitoring paint spray and paint shops is possible with the line type heat detector ADW 535HDx. Concerning planning and mounting the sensing tube, there are points that need to be taken into account (e.g. thermal conductivity and condensation on paint/coating due to the work process). For this reason consult with the manufacturer of the ADW 535HDx before implementation.



#### Use in potentially explosive atmospheres

- The ADW 535HDx evaluation unit **is permitted** to be used in potentially explosive atmospheres of zone 2 or 22 in accordance with VDE 0165 and IEC 60079-10.
- The ADW 535HDx evaluation unit **is not permitted** to be installed in potentially explosive atmospheres of zones 0, 20, 1 and 21.
- The sensing tube may be conveyed in zones 0, 20, 1 and 21 after consulting with the responsible offices. When using in these Ex-zones, **only** the sensing tube is permitted in the zone. The ADW 535HDx evaluation unit must be installed outside Ex zones 0, 20, 1 or 21 in zone 2 or 22!

### 4.10 Environmental influences



#### Notices

- On the basis of the conducted tests, the ADW 535HDx may be used in an environment that is within the scope of the type approvals. The environmental conditions as described in Sec. 13 must also be observed. Non-observance can negatively impact proper functioning of the ADW 535HDx.
- For special applications (e.g. in Arctic or tropical climates, in ship applications, high-level EMC environments, high impact etc.) please contact the manufacturer of the ADW 535HDx for empirical values and special application guidelines.

## 5 Mounting

### 5.1 Mounting guidelines



#### Use in potentially explosive atmospheres

The safety regulations (according to [BetrSichV](#), IEC 60079-17) and the device safety regulations as well as the generally recognised rules and technology applicable to installing and operating electrical operating materials are to be observed.

- **Sensing tube and evaluation unit** must be connected using a suitable means to the **equipotential bonding** (earthing) (see also Sec. 5.3 and 5.4.2)!
- Before the ADW 535HDx evaluation unit is opened, it must be ensured that it is de-energized and that appropriate protective measures are used.
- The electrical installation must be performed using cables with one-wire conductors measuring 0.5 – 2.5 mm<sup>2</sup>.
- The stripping length for connecting to the existing terminals is 6 mm.
- The terminals are to be tightened with a torque M of 0.5 Nm.
- The lines are to be conveyed through the cable and line entries!
- Three corresponding cable and line entries M20 (Ø 7–13°mm) are included. Additional ones in this size and in size M25 (Ø 11–17°mm) are optionally available.
- The M20 cable screw unions are suitable only for areas with a low risk of mechanical hazard. If necessary, these cable screw unions must be mechanically protected by suitable means (impact protection device).
- To ensure the required minimum protection type, the cable and line entries and the blind plugs must be firmly tightened! The following torques are to be used for installation in the housing and for tightening the cable entry:
  - ⇒ Cable and line entries M20 (Ø 7–13°mm) torque M of 3.8 Nm
  - ⇒ Cable and line entries M25 (Ø 11–17°mm) torque M of 5 Nm
- To protect against twisting and additional cable strain, the connection cables must be mechanically secured immediately before entering the ADW housing (e.g. with cable clamp).
- Unused cable and line entries must be sealed with the original blind plugs!
- Before the housing cover is mounted, the state and position of the seal must be checked.
- The screw plugs of the housing cover must be firmly and uniformly tightened.
- Transport and storage of this operating material are permitted only when the original packaging is used.



## Notices

**Material and products.** When the installation is set up, only the following supplied, approved and listed materials may be used:

- Evaluation unit, additional modules
- Sensing tube material and accessory materials (acc. to T 140 362).

Materials from other sources do not conform to EN 54-22 approval and may only be used if the manufacturer's written consent has been obtained.

Installation materials such as cables, intermediate distributors and fastening materials are usually supplied by the customer. Rust-proof screws are to be used for system parts (V4A).

**Tools for handling the evaluation unit.** The tools listed below are required for mounting and installation (sorted in the sequence in which they are used in this document):

- |   |                                       |
|---|---------------------------------------|
| • Opening the evaluation unit                                     | Phillips-head screwdriver no. 2       |
| • Module holder for additional modules                            | Torx screwdriver T10                  |
| • Terminals   | no. 1 flat-blade screwdriver (3.5 mm) |
| • Cable and line entries M20/M25                                  | no. 25/30 torque fork wrench          |
| • Replacing LMB main board  | no. 1 Phillips-head screwdriver       |
| • Replacing LMB main board on ADW 535-2HDx (additional)           | no. 5.5 fork wrench                   |
| • Replacing LEB extension board                                   | no. 1 Phillips-head screwdriver       |
| • Replacing LSU supervising unit                                  | no. 1 Phillips-head screwdriver       |
| • Replacing LSU supervising unit                                  | no. 12 fork wrench                    |
| • Sensing tube connection to the evaluation unit                  | no. 10 fork wrench                    |
| • Sensing tube screw junction for copper and stainless-steel tube | no. 10 fork wrench                    |
| • Sensing tube screw connection for Teflon tube                   | no. 10 and 12 fork wrench             |

## 5.2 Dimensioned drawing / drilling plan for evaluation unit ADW 535-2HDx (-1HDx)

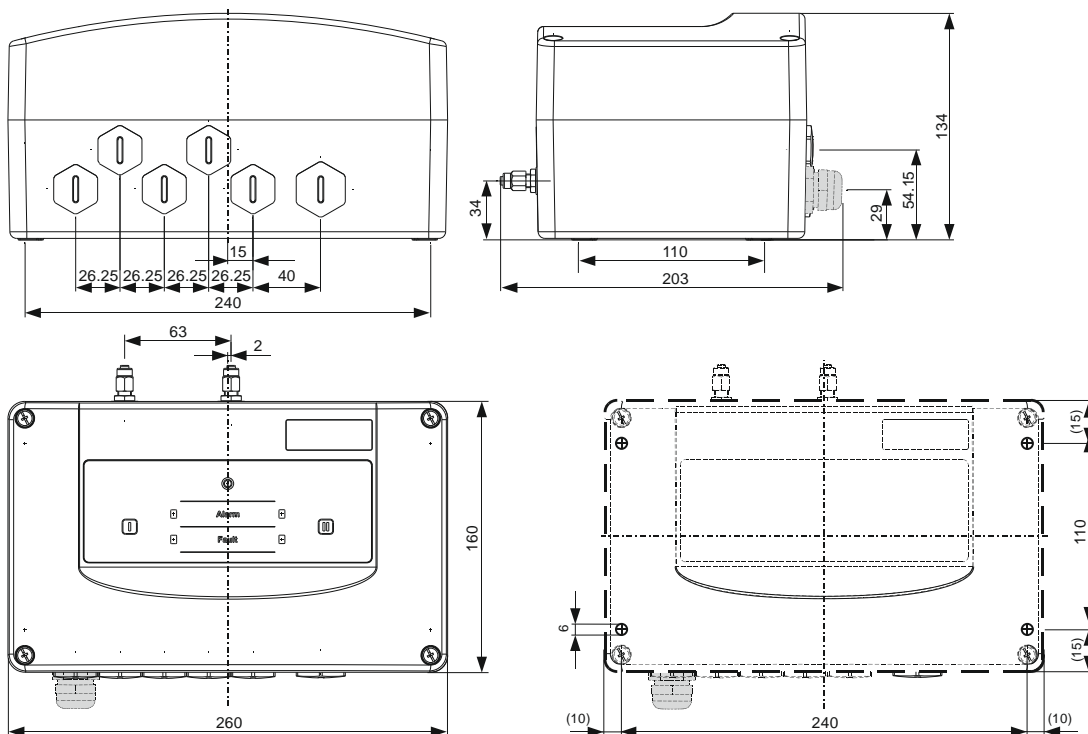



Fig. 15 Dimensioned drawing, drilling plan for evaluation unit

### 5.3 Material for the sensing tube

If the sensing tube is to be used in extremely corrosive environments, provide for sufficiently resistant tube materials. The available sensing tube materials and their application are listed below:

Material	Use
Copper (Cu)	Standard sensing tube for applications with normal ambient temperatures: <ul style="list-style-type: none"> <li>• -40 – +300°C → ② (when used at 85°C and above, use metal pipe clamps).</li> </ul>
Stainless steel (St) ③	Sensor tube for applications in corrosive environments, especially in the food industry for hygienic reasons: <ul style="list-style-type: none"> <li>• -40 – +300°C (when used at 85°C and above, use metal pipe clamps).</li> </ul>
Teflon (PTFE) Teflon (PTFE/Ex) ① 	Sensor tube for applications in very corrosive and aggressive environments. <ul style="list-style-type: none"> <li>• -40 – +200°C (when used at more than 85°C, metal pipe clamps and brass screw-junction pieces must be used; if more than 120°C the screw-junction pieces incl. terminal screw fitting must be outside of the monitored area).</li> </ul>
Flexible hose (FH 5/3 PA)	Copper, stainless steel or Teflon supply line for the sensing tube: <ul style="list-style-type: none"> <li>• -40 – +100°C → For applications over 100°C the transition from the flexible hose to the sensing tube (screw union) must be outside the monitored area.</li> </ul>



#### Use in potentially explosive atmospheres

① When using **Teflon sensing tube** the use of **TU 6/4 PTFE/Ex** is imperative (black, electrically conductive)!  
**Remark:** The **TU 6/4 PTFE/Ex** is **not** tested in compliance with **EN 54-22**.



#### Notices

Pipe materials other than those listed above may be used only after consulting with the manufacturer of the ADW 535HDx and with the manufacturer's written consent. Use only tubing materials (material, supplier, dimensions) that have been tested and approved by the manufacturer of the ADW 535HDx.

- ② Higher temperatures are possible after consulting with the manufacturer.
- ③ When using stainless steel sensing tubes in corrosive environments, a PS TU 5/4 St protective screw-junction piece must be used in order to protect the brass sensing tube connection on the ADW map case (see T 140 362). Details for handling this protective screw-junction piece can be seen on the instruction sheet.

A list of the available **materials for the sensing tubing** (pipes, screw-junction pieces etc.) for the ADW 535HDx is available in a separate document (T 140 362).

### 5.4 Types of mounting



#### Notice

The mounting types described in Sec. 5.4 that follows are decisive for the proper functioning of the ADW 535HDx. The specifications must therefore be strictly adhered to. Deviations are permitted only with the written consent of the manufacturer.

#### 5.4.1 Evaluation unit

The evaluation unit can be mounted in the X, Y or Z axis. An easily accessible location should be chosen so that the detector box can be worked on without aides such as ladders and scaffolding.

The evaluation unit must not be exposed to direct sunlight.

For applications such as in tunnels or when outdoor mounting is necessary, the evaluation unit must be installed in an additional protective box (e.g. SOS alarm boxes in road tunnels).

On the sensor cable entry side, a minimum distance of 10 cm to customer-side parts must be observed (protective boxes, niches etc.).

The evaluation unit is generally to be installed in an area where the relevant conditions for the evaluation unit apply as specified in Sec. 13 (also valid for use in high ambient temperature areas).

### 5.4.2 Sensing tube

#### 5.4.2.1 Overview of sensing tube design



#### Use in potentially explosive atmospheres

When installing the sensing tube in a potentially explosive atmosphere, the following precautions must be strictly observed:

##### **Evaluation unit and sensing tube in potentially explosive atmospheres:**

- **Evaluation unit and sensing tube** must be connected with suitable means to the **equipotential bonding** (earthing) (see also Sec. 5.3)! When using metal sensing tubes (copper or stainless steel) directly from the ADW, the equipotential bonding of the evaluation unit is realised via the sensing tube immediately after the sensing tube connection (**Fig. 16; ①**). When using an ADW 535-2HDx (2 sensing tubes), the equipotential bonding of the evaluation unit on just one of the two sensing tubes is sufficient.
- When using **stainless steel sensing tubes and a evaluation unit in corrosive environments**, a **PS TU 5/4 St** protective screw-junction piece must be used in order to protect the brass sensing tube connection on the ADW map case (**Fig. 16; ②**, art no. see T 140 362). Details for handling this protective screw-junction piece can be seen on the instruction sheet.
- When using **Teflon sensing tube** the use of **TU 6/4 PTFE/Ex** is imperative (black, electrically conductive)! **Remark:** The **TU 6/4 PTFE/Ex** is **not** tested in compliance with **EN 54-22**. The TU 6/4 PTFE/Ex Teflon sensing tube must also be connected to the equipotential bonding (**Fig. 16; ③**). As the ADW TU 6/4 adapter is used for connection on the ADW, the evaluation unit also has to be connected to the equipotential bonding (from the interior of the evaluation unit, see below and **Fig. 16; ④**).
- If a supply line with flexible hose FH 5/3 PA is present from the ADW, a short piece of metal sensing tube can first be installed for the equipotential bonding of the evaluation unit (**Fig. 16; ⑤**), or the equipotential bonding has to be made from the interior of the evaluation unit (see below and **Fig. 16; ④**).
- When using a PS TU 5/4 St protective screw-junction piece or TU 6/4 PTFE/Ex Teflon sensing tube, the equipotential bonding of the evaluation unit has to be made inside the evaluation unit (**Fig. 16; ④**). The following material is recommended by the manufacturer (can be purchased directly from the supplier U.I. LAPP GmbH):
  - ⇒ Press-fit cable lug 4 – 6 mm<sup>2</sup> M6 → U.I. LAPP GmbH; L-RC 6; art. no. 63104360
  - ⇒ Earth wire 4 mm<sup>2</sup> green/yellow → U.I. LAPP GmbH; H07Z-K; art. no. 4726003
  - ⇒ Cable screw union M12 ATEX → U.I. LAPP GmbH; SKINTOP K-M; art. no. 54115200
  - ⇒ Reduction M20 – M12 PA → U.I. LAPP GmbH; SKINDICHT KU-M; art. no. 52104470
- Supply lines with the flexible hose FH 5/3 PA must be conveyed in **metallically conductive protective tubes**. These protective tubes must be connected to the equipotential bonding with suitable means.
- **Test coils** can be used only if it can be ensured that they can be steamed up with alternative heat sources such as hot water or steam. Testing the response characteristics of the ADW 535HDx by means of effective fire characteristic “heat” (hot air blower) is not possible due to the potentially explosive atmosphere (see also Sec. 7.7.2).

##### **Evaluation unit in safe area / sensing tube in potentially explosive atmosphere:**

- If the **evaluation unit** is located **outside** the potentially explosive atmosphere, it does **not** have to be connected to the equipotential bonding. In contrast, the **sensing tube must** be connected to the **equipotential bonding** when entering the potentially explosive atmosphere.
- If the **evaluation unit** is located **outside** the potentially explosive atmosphere, installation can be made in the monitored potentially explosive atmosphere using a supply line (flexible FH 5/3 PA hose) through the different Ex zones 1 / 2 and 21 / 22 (conveyance in metallically conductive protective tubes, connected to equipotential bonding).

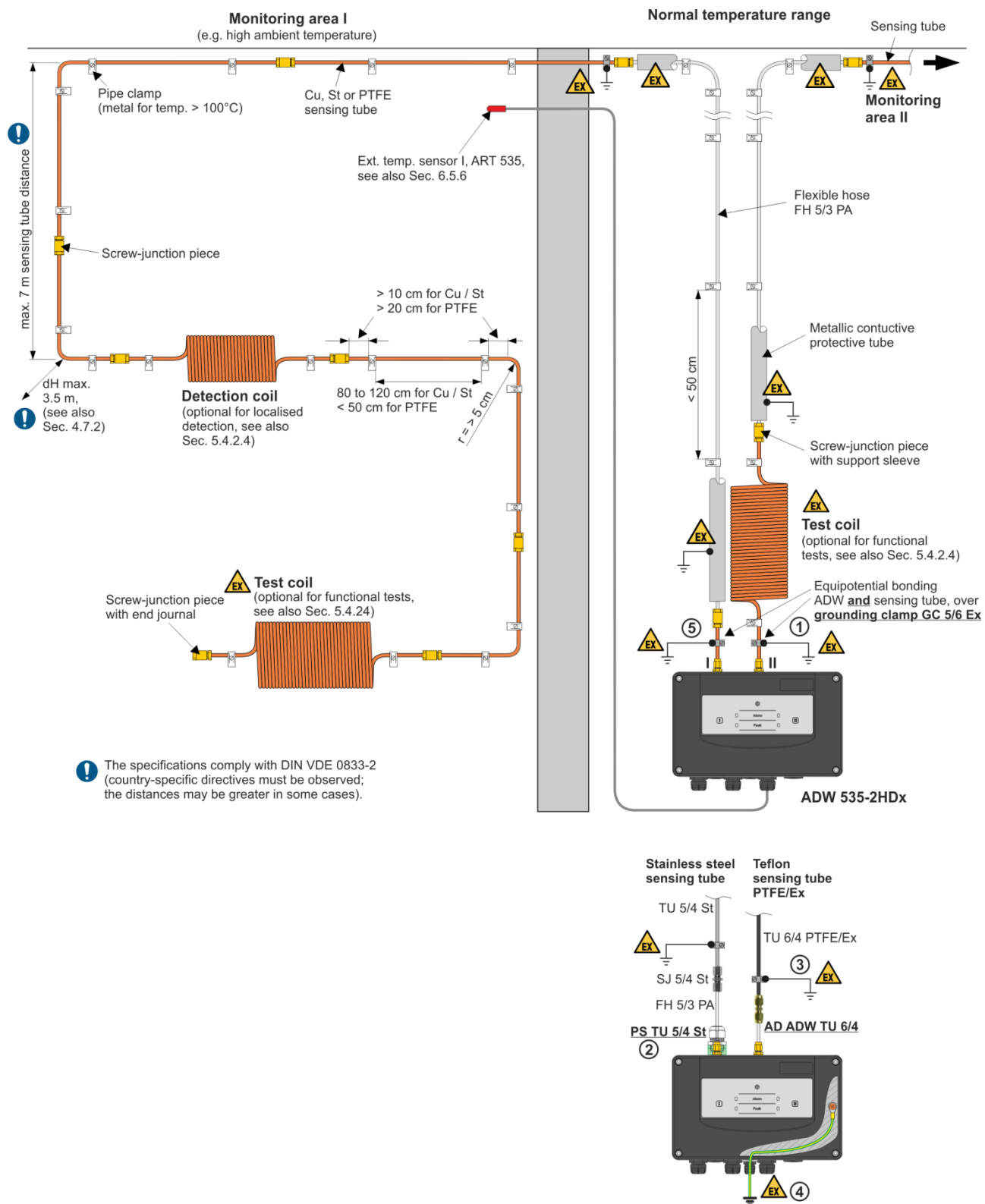
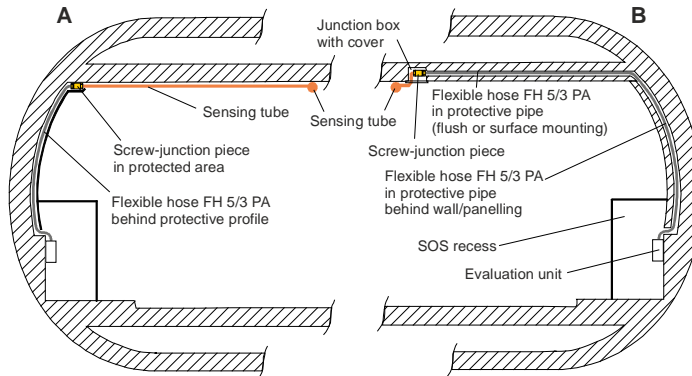

Fig. 16 Overview of sensing tube design

## 5.4.2.2 Sensing tube ascent and mounting

Connection of the evaluation unit to the sensing tube is usually by means of the flexible hose. The flexible hose must be mechanically protected with suitable means (protective pipe). The sensing tube can also be connected directly to the evaluation unit (e.g. for industrial applications).

The following example illustrates two options for sensing tube ascent in tunnels.



**Fig. 17 Example of sensing tube ascent in tunnels**

- **A.** The sensing tube (here copper) traverses from the centre of the tunnel to the side wall. There a screw-junction piece connects the sensing tube to the flexible hose. The flexible hose is conducted behind a protective profile into the SOS recess to the evaluation unit. **Important:** The transition from tunnel ceiling to the side wall and from the sensing tube to the flexible hose should be in the protected area if at all possible (covering).

or:

- **B.** Flexible hose which is drawn through a flush or surface mounted protective pipe traverses the tunnel. The flexible hose is conducted in the protective pipe behind the tunnel wall panelling into the SOS recess to the evaluation unit.

The sensing tube ascent can also be a combination of **A** and **B**.

## 5.4.2.3 Handling sensing cable in general

When arranging and mounting the sensing tube, the points below must be observed and adhered to:

- The sensing tube must be routed in a way that does not impact the lateral visual angle (**Fig. 18**).
- Avoid routing the sensing tube next to, beneath or above the lighting bands. A minimum distance of 0.5 m must be observed.
- For applications in tunnels, the sensing tube must generally be mounted in the centre of the tunnel, with a lateral tolerance of 0.5 m (for exceptions see Sec. 4.7.1).
- To bypass hindrances in the ceiling construction (ceiling openings, beams, etc.), you can deviate from the basic rules above. Ensure that the directional changes required to bypass hindrances in tunnels do not deviate more than 45° from the normal tube routing axis. If a change of direction or a crossing at an angle of 90° is absolutely necessary, these tube sections must be mechanically protected.
- The sensing tube is mounted directly onto the ceiling with plastic pipe clamps. In tunnels it is also possible to mount on the underside of cable ducts as long as the ducts are no farther than 0.5 m to the ceiling.
- A distance of 25 m must be maintained from the end of the sensing tube to the portal in the portal areas of tunnels.

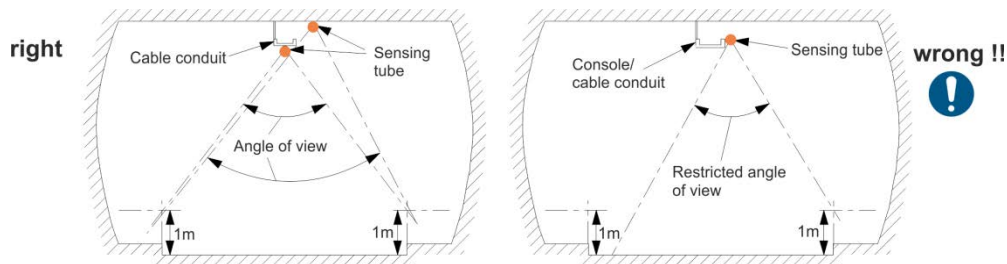

**Fig. 18 Angle of view for sensing tube mounting in tunnels**

- It is absolutely essential to maintain the maximum sensing tube lengths as described in Sec. 4.7.1 and 4.7.2 (incl. ascent to ceiling). Other sensing tube lengths mean that special sensing tubes have to be selected (see also Sec. 5.3).
- The sensing tube is fastened with the special plastic pipe clamps. Exception: When used in an environment with high ambient temperatures, use metal pipe clamps.
- Pipe clamp distance is 0.8 m to 1.2 m for copper and stainless-steel sensing tube and 0.5 m for Teflon sensing tube.
- Only rust-free screws may be used for fastening.
- Ensure that the pipe clamps and the sensing tube are laid in a straight line (plumb line) so that the tube can slide into the pipe clamps in the case of linear expansion due to temperature fluctuations.
- The tube pieces are connected to each other with screw-junction pieces. Make sure that the tube ends are cut at a right-angle and do not have protruding metal splinters (burrs) (**Fig. 19**).
- Use a screw-junction piece with end journals at the end of the sensing tube (**Fig. 19**). Mount these only after blowing out the sensing tube.
- The distance from the end piece of one sensing tube to the end piece of the following sensing tube must not be less than 0.5 m (length expansion).
- A support sleeve must always be used for the screw-junction pieces connecting the sensing tube to the flexible hose (**Fig. 19**).
- A safety distance of min. 10 cm (copper and stainless-steel sensing tube) or 20 cm (Teflon sensing tube) must be maintained between pipe clamps and screw-junction pieces & bends (due to length expansion of the sensing tube).
- The ascent to the ceiling should be realised only with a flexible hose if possible. The flexible hose must be routed in a protective tube for mechanical protection.
- A minimum bending radius of 5 cm of the sensing tube and flexible hose must be observed (danger of crushing). Furthermore, ensure that any existing bends in the flexible hose cannot be crushed later on (fasten before and after the bend).
- Upon completing the mounting, the entire sensing tube including ascent towards the end piece must be blown out (cleaned) with oil-free compressed air or nitrogen. The instructions for this procedure are described in Sec. 5.4.2.5.



## Notice

The evaluation unit must not yet be connected at this time under any circumstances.

- If it is still not possible to connect the sensing tube to the evaluation unit after being blown out, the concerned end must be terminated using appropriate means in a way that does not allow dust or moisture to penetrate.



## Notices

- A screw-junction piece can be used only once!
- The screw-junction piece must be tightened only to the point at which the thread is no longer visible.

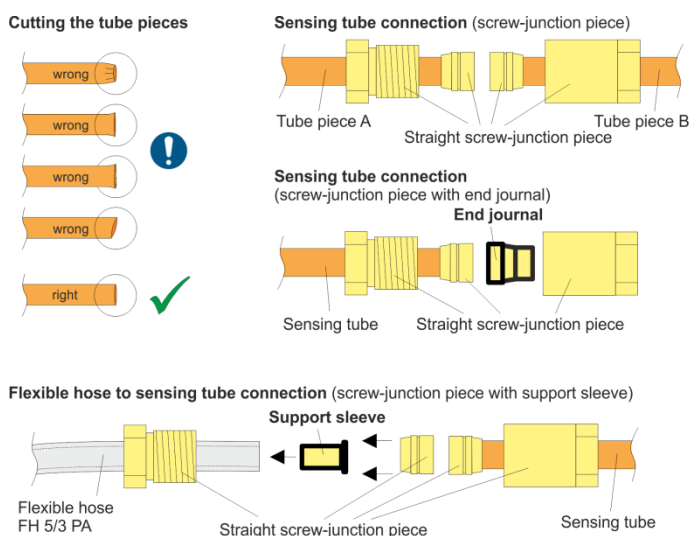

**Fig. 19 Sensing tube connections**

### 5.4.2.4 Deployment and mounting of detection coils and test coils



#### Use in potentially explosive atmospheres

**Test coils** can be used in potentially explosive atmospheres only if it can be ensured that they can be steamed up with alternative heat sources such as hot water or steam. Testing the response characteristics of the ADW 535HDx by means of effective fire characteristic “heat” (hot air blower) is not possible due to the potentially explosive atmosphere (see also Sec. 7.7.2).

**Detection coils** can be built into the sensing tube. They provide optimal monitoring of, for example, localised danger sources (equipment and object surveillance). Detection coils correspond to a sensing tube length of 5 m.

A **test coil** can be built in if object-specific functional tests (alarm releases) are necessary. Test coils correspond to a sensing tube length of 10 m.

See also **Fig. 16** concerning detection and test coils. When two test coils are used directly on the evaluation unit (for ADW 535-2HDx), they must be arranged in an offset manner to prevent both test coils from being simultaneously subjected to heat testing (hot air blower). It may be necessary to place an isolator between the test coils during testing.



#### Notices

The following rules must be observed when mounting detection and test coils:

- The volume of the detection and test coils corresponds to a certain sensing tube length. Thus, when calculating the overall length of the sensing tube, for each used **detection coil 5 m** of sensing tube must be taken into account and for each **test coil 10 m** of sensing tube must be taken into account. For this reason, detection coils and test coils must be taken into account during system planning in the project planning phase.
- Detection and test coils must not be exposed to direct sunlight.
- The local influence of temperature fluctuations may trigger false alarms on the detection and test coils.
- Heat impingement in the area of the detection coils may not comply with the requirements of EN 54-22 (the ADW may react more sensitively).
- Detection coils are always to be used only with equipment monitoring and object monitoring. They can be used for space surveillance if the available mounting length of the sensing tube is limited to less than 10 m.
- The test coil can be positioned at the ADW 535HDx evaluation unit or at the end of the sensing tube.
- The test coil should never be located in the monitored area.
- It may be necessary to install the test coil in a lockable box (protection against vandalism).

5.4.2.5 Testing the sensing tube

After the sensing tube is mounted, dust and moisture must be removed from the entire sensing tube. Also at this time a first sealing test can be performed.

**Notice**  
**Under no circumstances** may the evaluation unit be connected for cleaning and sealing check work.

**Use in potentially explosive atmospheres**  
 The ACMS 535 mini-compressor may be used only if **no potentially explosive atmospheres** are in the system!

Moisture-free air (oil-free compressed air or nitrogen) must be used for the cleaning and sealing check. For this purpose the manufacturer of the ADW 535HDx can provide the **ACMS 535 “mini-compressor”** for testing. A cleaning and sealing check with the **“Nitrogen set”** is of course also possible (for handling see Technical description ADW 511A, T 139 420, Sec. 5.3.2.2).

**Test procedure**

Testing takes place at the beginning of the sensing tube where the evaluation unit is connected (**Fig. 20**).

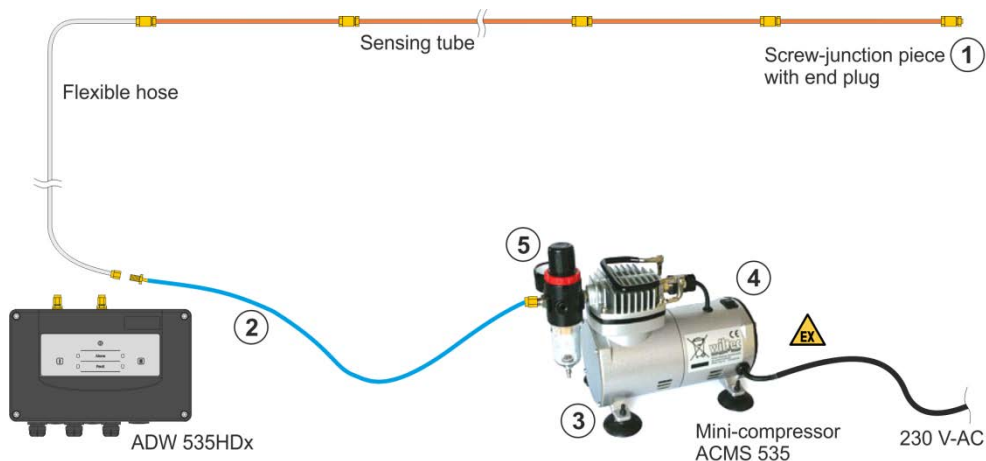

**Fig. 20 Mini-compressor connection**



### Notices

- Before using the mini-compressor, check whether condensation is in the water filter. If this is the case, the collected water **must** be drained out using the drain valve. It is imperative to prevent moisture from entering the sensing tube.
- If water collects in the water filter during cleaning (point (8)), this indicates that moisture or water residues are in the sensing tube. In this case the nitrogen set must be used for cleaning the concerned sensing tube.

#### Sealing check

- (1) The end journal must be used at the end of the sensing tube ① (in the sensing tube termination).
- (2) Connect the sensing tube (flexible hose) via the connection hose ② to the mini-compressor ③.
- (3) Switch on the mini-compressor at the main switch ④ and wait until a pressure of **4 bar** is generated → check on the manometer ⑤. The mini-compressor switches off automatically when this pressure is reached.
- (4) The pressure on the manometer ⑤ must be observed for **3 min** → there **must not be any recognisable drop in pressure!!**
  - ! If a pressure drop occurs, use leak spray to easily find leaks (spray all connection points including termination). After a repair, repeat points (1) to (4).
- (5) Switch off the mini-compressor on the mains switch ④.

#### Cleaning

- (6) Pressure is still present in the sensing tube from the preceding sealing check.
- (7) **Quickly unscrew** the screw-junction piece at the end of the sensing tube ① (sensing tube termination) with a fork wrench and completely remove the outer part. **Make sure the end journal does not become lost!!**
- (8) The overpressure in the sensing tube escapes quickly; any dust and remaining moisture are removed → wait about **3 min** until the air has completely escaped from the sensing tube.
- (9) Completely close the sensing tube termination ① at the end of the sensing tube (mount end journal).
- (10) Log the test.

## 6 Installation



### Use in potentially explosive atmospheres

The safety regulations (according to [BetrSichV](#), IEC 60079-17) and the device safety regulations as well as the generally recognised rules and technology applicable to installing and operating electrical operating materials are to be observed.

- The sensing tube must be connected to equipotential bonding (earthing) (see also Sec. 5.3 and 5.4.2)!
- Before the ADW 535HDx evaluation unit is opened, it must be ensured that it is de-energized and that appropriate protective measures are used.
- The electrical installation must be performed using cables with one-wire conductors measuring 0.5 – 2.5 mm<sup>2</sup>.
- The stripping length for connecting to the existing terminals is 6 mm.
- The terminals are to be tightened with a torque M of 0.5 Nm.
- The lines are to be conveyed through the cable and line entries!
- Three corresponding cable and line entries M20 (Ø 7–13°mm) are included. Additional ones in this size and in size M25 (Ø 11–17°mm) are optionally available.
- The M20 cable screw unions are suitable only for areas with a low risk of mechanical hazard. If necessary, these cable screw unions must be mechanically protected by suitable means (impact protection device).
- To ensure the required minimum protection type, the cable and line entries and the blind plugs must be firmly tightened! The following torques are to be used for installation in the housing and for tightening the cable entry:
  - ⇒ Cable and line entries M20 (Ø 7–13°mm) torque M of 3.8 Nm
  - ⇒ Cable and line entries M25 (Ø 11–17°mm) torque M of 5 Nm
- To protect against twisting and additional cable strain, the connection cables must be mechanically secured immediately before entering the ADW housing (e.g. with cable clamp).
- Unused cable and line entries must be sealed with the original blind plugs!
- Before the housing cover is mounted, the state and position of the seal must be checked.
- The screw plugs of the housing cover must be firmly and uniformly tightened.
- Transport and storage of this operating material are permitted only when the original packaging is used!

### 6.1 Regulations



#### Notices

- The electrical installation is to be carried out in accordance with the applicable country-specific regulations, standards and guidelines. Likewise, the local provisions must also be observed.
- Besides country-specific regulations and guidelines, the specifications concerning the requirements for installation cables and conductor cross-sections as described in Sec. 4.8 must be observed and implemented.

### 6.2 Cable entry



#### Notice

Make sure the power is disconnected for all connection and wiring work on the ADW 535HDx.

Three M20 cable screw unions are included in the mounting set (supplied with the evaluation unit) for the electrical installation. These are to be used as needed after removing the blind plugs in the ADW housing (see Sec. 6 “**Use in potentially explosive atmospheres**”, Notice on torque and example in **Fig. 21**). If needed, additional cable screw unions (optionally available) can be fitted in the remaining reserve holes (blind plugs).

The cable screw unions are suitable for cables with external diameters ranging between 7 and 13 mm (M20) or 11 and 17 mm (M25).



#### Notices

- Unused reserve holes for cable screw unions must be sealed with the original blind plugs to comply with protection class IP 65 and ATEX in operation (see also Notice in Sec. 6 “**Use in potentially explosive atmospheres**”).
- **Use in compliance with UL 521:** When using the ADW 535HDx in compliance with UL 521, special **1/2”** and **3/4”** cable screw unions are to be used (customer-side). To be able to use them in the ADW housing, the concerned M20 and M25 blind plugs must be removed and replaced by 1/2” M20 adapters and 3/4” M25 adapters. The adapters are available from the manufacturer in the **AD US M-inch** range of accessories.

### 6.3 Installing additional modules XLM 35, RIM 36, SIM 35

There are four expansion slots for fitting the evaluation unit with optional additional modules. Given the modular assignment of ribbon cable connectors on the LMB 35 main board (see also Sec. 3.2, Fig. 6), it is recommended to observe the arrangement shown in Fig. 21.

The mounting set of each module comprises a module holder and a connecting cable (ribbon cable) for connecting to the LMB 35. The retainer screw in the module holder is not used. For fastening the module holder, the screw (M3) at the relevant place on the base plate of the evaluation unit is used. Use a **Torx screwdriver T10** to tighten the mounting screw. The module can be removed from the module holder for mounting in the evaluation unit and for the subsequent electrical installation.

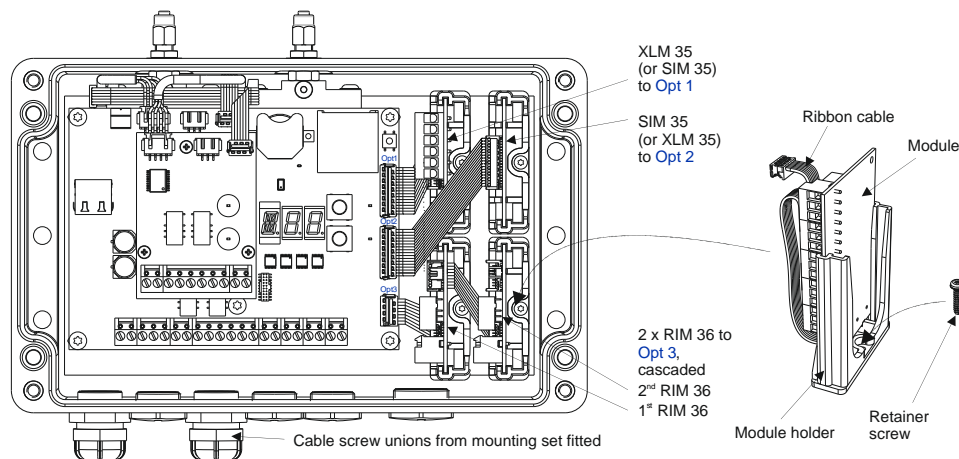

Fig. 21 Installing additional modules



#### Notice

The additional modules are automatically detected when the device is switched on, from which point on they are monitored and functional. When subsequently removing an additional module (e.g. because it is not being used), the additional modules must first be logged off via operation on the LMB 35 main board (o switch position, see Sec. 7.3.7).

The UMS 35 universal module holder is available for installing modules other than XLM, RIM or SIM. It is fastened in the evaluation unit instead of the above described module holder and requires two expansion slots one above the other (directly next to the LMB 35). The UMS 35 consists of an angled sheet metal plate with various fastening options for additional modules.



#### Notice, XLM 35 installation

With the installation of the use of an XLM 35, the ADW 535HDx meets the requirements in compliance with **EN 54-17** (short-circuit isolation). To ensure that the required identification is recognisable in compliance with EN 54-17, the supplied **identification sign must** be easily visible **outside** on the ADW map case and attached in the immediate vicinity of the ADW rating plate (same side) when the XLM 35 is installed.



#### Use in potentially explosive atmospheres

When using the ADW 535HDx in potentially explosive atmospheres, **only** the **RIM 36**, **XLM 35** and **SIM 35** additional modules may be installed in the ADW. The installation of other modules such as the **BX-OI3** or **line modules from external FACPs** is **not permitted**. Such modules may only be installed in separate Ex-approved map cases and are the personal responsibility of the supplier or user of the modules (see also Sec. 6.5).

The receiver modules (opposite side) of the XLM 35 and SIM 35 additional modules must be positioned outside of the Ex-zone in the safe area.

### 6.4 Electrical connection

The electrical connection is implemented by means of plug-in screw terminals. Use a **no. 1 flat-blade screwdriver** (3.5 mm) to tighten the screw terminals. Individual terminal blocks are fitted for the supply voltage, relay contacts, inputs, outputs, etc. (in Sec. 6 see also the Notice “**Use in potentially explosive atmospheres**” on line type, stripping length, torque).



#### Notices

- Inside the evaluation unit the lines should be routed to the terminals using the shortest possible path. Reserve loops via the main board are to be avoided (EMC).
- **Caution:** For monitoring the automatic fire detector, **no looped lines** may be connected to terminals “**Alarm I**”, “**Fault I**”, “**Alarm II**” or “**Fault II**”. The looped line must be interrupted to enable connection monitoring.

### 6.4.1 Terminal assignment for the LMB 35 main board

LMB terminal	Signal		Wiring
1	PWR +	+9 to +30 VDC ①	Main supply line from FACP or external according to <b>Fig. 22</b>
2	PWR –	0 V	
3	PWR-R +	+9 to +30 VDC ①	Redundant supply line from FACP or external according to <b>Fig. 22</b>
4	PWR-R –	0 V	
5	+OC	+ power supply	Connection of feedback loop signals according to <b>Fig. 29</b>
6	Flt OC Out1	OC output Fault I	
7	Al OC Out1	OC output Alarm I	
8	Rel Flt1 (“NO”) ②	Fault I	Connection of the line acc. to <b>Fig. 26</b> or <b>Fig. 27</b> and specifications of the used line
9	Rel Flt1 (“NC”)		
10	Rel Flt1 “COM” ②		
11	Rel Al1 “NO”	Alarm I	
12	Rel Al1 “NC”		
13	Rel Al1 “COM”		
14	TempSens1 +	External temperature sensor I	Connection according to <b>Fig. 30</b>
15	TempSens1 –		
16	ResExt +	Reset external input (opto-isolator input)	Connection according to <b>Fig. 23</b> and <b>Fig. 25</b>
17	ResExt –		
18	InPrg1 +	Day/night control from FACP (opto-isolator input)	Connection acc. to schematic <b>Fig. 23</b>
19	InPrg1 –		
20	InPrg2 +	Reserve, no function (opto-isolator input)	
21	InPrg2 –		



#### Notices

- ① With UL/FM = +10.6 to +27 VDC.
- ② The relay “Flt1” (fault) is picked up in the quiescent state → Contact terminal 10/8 closed, 10/9 open (ADW 535HDx under voltage; no fault event present).

### 6.4.2 Terminal assignment of LEB 35 extension board

LEB terminal	Signal		Wiring
22	Flt OC Out2	OC output Fault II	Connection of feedback loop signals, acc. to <b>Fig. 29</b>
23	Al OC Out2	OC output Alarm II	
24	Rel Flt2 (“NO”) ①	Fault II	Connection of the line acc. to <b>Fig. 26</b> or <b>Fig. 27</b> and specifications of the used line
25	Rel Flt2 (“NC”)		
26	Rel Flt2 “COM” ①		
27	Rel Al2 “NO”	Alarm II	
28	Rel Al2 “NC”		
29	Rel Al2 “COM”		
30	TempSens2 +	External temperature sensor II	Connection according to <b>Fig. 30</b>
31	TempSens2 –		



#### Notice

- ① The relay “Flt2” (fault) is picked up in the quiescent state → Contact terminal 26/24 closed, 26/25 open (ADW 535HDx under voltage; no fault event present).

## 6.4.3 Terminal assignment for SecuriLine eXtended module XLM 35

XLM Terminal	Signal	Wiring
L1	Data A	Addressable loop acc. to <b>Fig. 25</b> or <b>Fig. 28</b> (see also Sec. 8.5.5)
C1	GND A	
G1	Screen	
L2	Data B	Addressable loop acc. to <b>Fig. 25</b> or <b>Fig. 28</b> (see also Sec. 8.5.5)
C2	GND B	
G2	Screen	

## 6.4.4 Terminal assignment for RIM 36 relay interface module

RIM terminal	Signal ①	Wiring	
1	Diff alarm of sensing tube I (II) or freely programmable	Local info or connection to input of FACP	
2			Rel. 1
3			
4	Max alarm of sensing tube I (II) or freely programmable		
5			Rel. 2
6			
7	Reserved for pre-signal Diff alarm of sensing tube I (II) or freely programmable		
8			Rel. 3
9			
10	Reserved for pre-signal Max alarm of sensing tube I (II) or freely programmable		
11			Rel. 4
12			
13	Alarm LMB temperature sensor or freely programmable		
14			Rel. 5
15			



### Notice

- ① Depending on the device version, the assigned criteria (signals) upon product delivery apply to sensing tube I on the 1<sup>st</sup> RIM 36 (connected to LMB 35) and sensing tube II on the 2<sup>nd</sup> RIM 36 (connected to the 1<sup>st</sup> RIM 36, cascaded). The assignment of individual or all relays can be changed with the “ADW Config” configuration software.
- If two RIM 36 devices are used on the ADW 535-1HDx, the relays of the 2<sup>nd</sup> RIM 36 are not configured with any default criteria. The required programming must be performed with the “ADW Config” configuration software.

## 6.4.5 Terminal assignment of an SIM 35 serial interface module

SIM terminal	Signal	Wiring / installation (see also Sec. 8.5.6)	
1	GND	Input	1 <sup>st</sup> conductor from wire pair 2
2	D +		1 <sup>st</sup> conductor from wire pair 1
3	D –		2 <sup>nd</sup> conductor from wire pair 1
4	GND	Output	1 <sup>st</sup> conductor from wire pair 2
5	D +		1 <sup>st</sup> conductor from wire pair 1
6	D –		2 <sup>nd</sup> conductor from wire pair 1

## 6.5 Connection variants



### Notice

The connection variants are determined by the possible line and FACP technologies used. For more information on connecting alarm transmitters, line monitoring elements, etc., please contact the manufacturer and/or supplier of the fire alarm system.

In all cases the ADW 535HDx must have an emergency power supply (country-specific, e.g. compliant with EN 54-4).



### Use in potentially explosive atmospheres

The extent to which the ADW 535HDx may be connected to line and FACP technology (also third-party lines) depends on country-specific approvals and regulations. In all cases the connection of an ADW 535HDx to an FACP must be approved by the responsible office **see also Sec. 6.3**.

Generally, the following applies when using alarm resistances, alarm transmitters, diodes etc. in the ADW 535HDx:

Under **no** circumstances should these elements be allowed to heat up to more than **maximal 40°C** in long-term operation, in the event of a fault, alarm or short-circuit!

### 6.5.1 Power supply



### Use in potentially explosive atmospheres

The **power supply** of the ADW 535HDx in potentially explosive atmospheres must be made **from the FACP in the safe area** (outside the Ex-zone). If the power supply from the FACP is not possible, the **additional power supplies must also be located in the safe area**.

The ADW 535HDx must always have an emergency power supply. Depending on the output current available at the fire alarm control panel (FACP) and the number of ADW 535HDx units to be connected, the power supply can be provided by the FACP; alternatively, an additional power supply must be provided locally.

The supply is via terminals 1 and 2. In applications which stipulate a redundant power supply line (country-specific), it is routed to terminals 3 and 4 (**Fig. 22**).

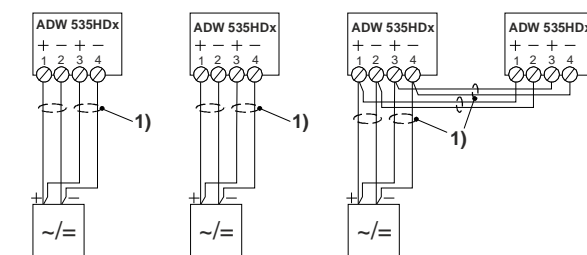
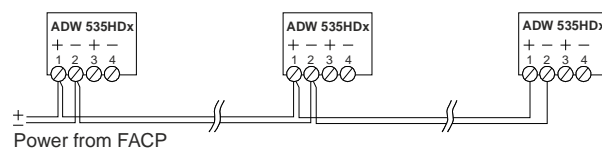

Local power, individual      Local power, by zone  
1) redundant power supply line (optional, country-specific)

**Fig. 22** Types of power supply



### Notices

- The supply inputs are not connected internally in the ADW and therefore cannot be used for direct forwarding to neighbouring systems.
- The terminals of the ADW 535HDx are designed for maximum 2.5 mm<sup>2</sup>. For forwarding the supply line to a neighbouring ADW it may therefore be necessary to install additional distributor or support terminals.



### Notice

To determine the required power supply and cable cross-section, the calculations set out in Sec. 4.8.2 must be carried out in all cases. For applications with redundant power supply, the calculations must be performed for both power supply lines individually.

## 6.5.2 Reset input

The reset input is potential-free (opto-isolator) and can be actuated on both the “plus” side and the “minus” side (**Fig. 23**). The input operates in the 5 to 30 VDC range and a pulse bandwidth of 0.5 to 10 s. Thanks to the continuous current consumption of approx. 3 mA across the entire operating range, actuation can be carried out directly via an OC output.

When a continuous signal is applied for longer than 20 s, the ADW 535HDx is switched inactive and the fault relay on the LMB 35 (on ADW 535-2HDx also the LEB 35) becomes active (triggers). Once the continuous signal is switched off, the ADW is re-armed. Switching inactive via the “Reset external” input works only if the ADW 535HDx is not equipped with an XLM 35.

## 6.5.3 Control

The ADW 535HDx units connected to an FACP are controlled according to the detection zone mapping using the FACP states “Zone ON/OFF” and “Reset”. Two possibilities are available:

- Control via voltage supply (auxiliary relays in the ADW power supply line)
- Control via the “Reset external” input

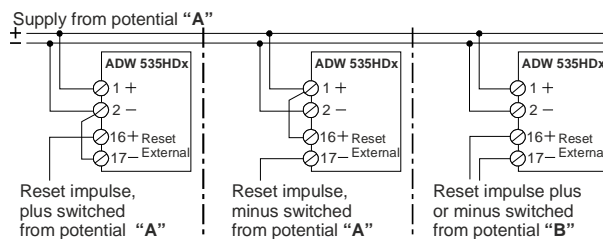

**Fig. 23 Reset input**



### Use in potentially explosive atmospheres

**Caution:** When control is via the “Reset external” input or from SecuriLine module XLM 35, the ADW 535HDx is supplied with voltage even if the zone (FACP) is switched off, **maintenance work!**

Prior to performing repairs and replacing parts on the ADW 535HDx (printed circuit board, supervising unit), the FACP and the local power (if present) of the ADW 535HDx must be de-energised – the line (loop) deactivated and the 24 VDC power supply of the ADW 535HDx switched off. Before carrying out any interventions on the ADW 535HDx it is necessary to check (measure) that the ADW 535HDx is no longer energised (terminal 1 and 2 or 3 and 4 on the LMB 35, and line terminals on control module / alarm transmitter).

### 6.5.3.1 Control via voltage supply by means of auxiliary relay

Depending on the location of the ADW supply, the auxiliary relay may be placed in the FACP or directly in the ADW 535HDx.

The auxiliary relay can be actuated in the following ways (see Fig. 24):

- A. line plus or minus
- B. SW output of the FACP
- C. SW output or function of a control module

The function types described above are determined by the FACP technology used; it is therefore essential to contact the manufacturer and/or the supplier of the FACP for details before implementing.

!

### Notices

- The EMC protective elements at the input of the ADW electronics cause a brief current peak (5 A / 1 ms) when the supply voltage is applied. When using auxiliary relays with a maximum contact rating of 1 A, this may lead to the relay contact sticking. For this reason auxiliary relays with a contact load of over **1 A** should **generally** be used, e.g. PMR 81 semi-conductor relay (see Fig. 24c)).
- The ADW supply path via the auxiliary relay contact must be short-circuit-proof or conducted through a fuse component (circuit-breaker card).
- When using a PMR 81 semi-conductor relay, it may be necessary to invert the actuation signal (PMR only has a normally open (NO) contact function).
- To guarantee comprehensive emergency running properties, the connection must in all cases be implemented in such a way that if there is an FACP computer failure the ADW will continue to function (reset input not actuated).

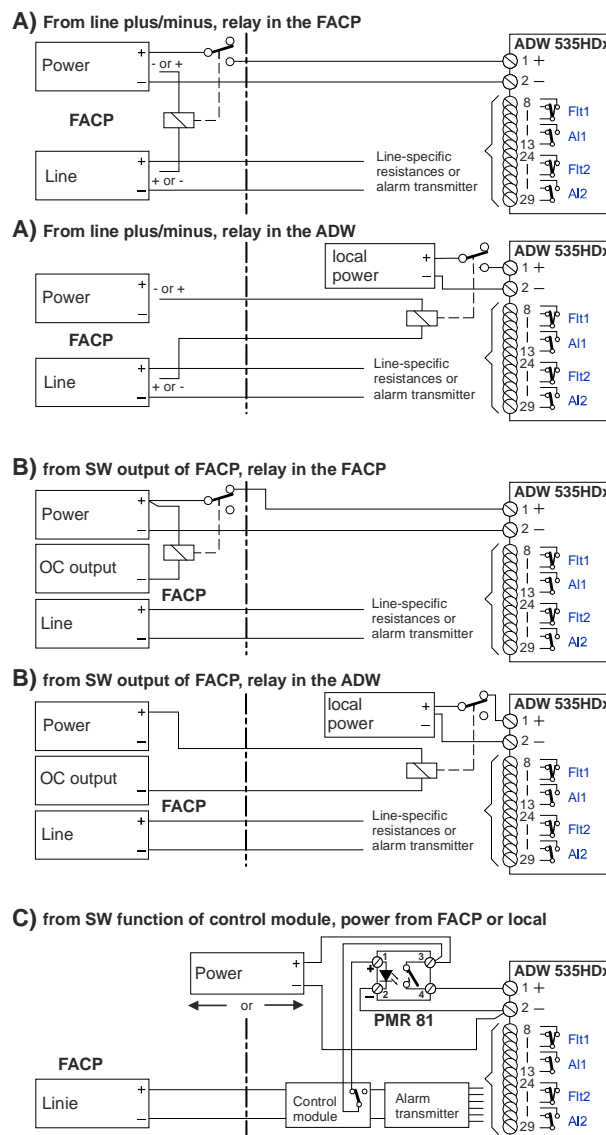

Fig. 24 Control via supply with relay

## 6.5.3.2 Control via input “Reset external”

The following options are available for control via the reset input (see Fig. 25):

- A. Control via auxiliary relay from line plus
- B. Control via auxiliary relay or semi-conductor relay (PMR 81) from control output (open collector)
- C. Control without auxiliary relay, directly from control output (relay contact or open collector)
- D. Control via addressable loop when using the XLM 35. The control is then not by means of the reset input but rather directly with the corresponding command entry via the XLM 35 on the ADW 535HDx.

The function types described above are determined by the FACP technology used; it is therefore essential to contact the manufacturer and/or the supplier of the FACP for details before implementing.



### Notice

- When using a PMR 81 semi-conductor relay, it may be necessary to invert the actuation signal (PMR only has a normally open (NO) contact function).
- To guarantee comprehensive emergency running properties, the connection must **in all cases** be implemented in such a way that if there is an FACP computer failure the ADW will continue to function (reset input not actuated).
- **Caution:** When control is via the “Reset external” input, the ADW 535HDx is supplied with voltage even if the zone (FACP) is switched off. For this reason the power supply line to the ADW must be disconnected to carry out any repair work (e.g. unplug terminals 1 and 2 on the ADW; also 3 and 4 in the case of a redundant supply).

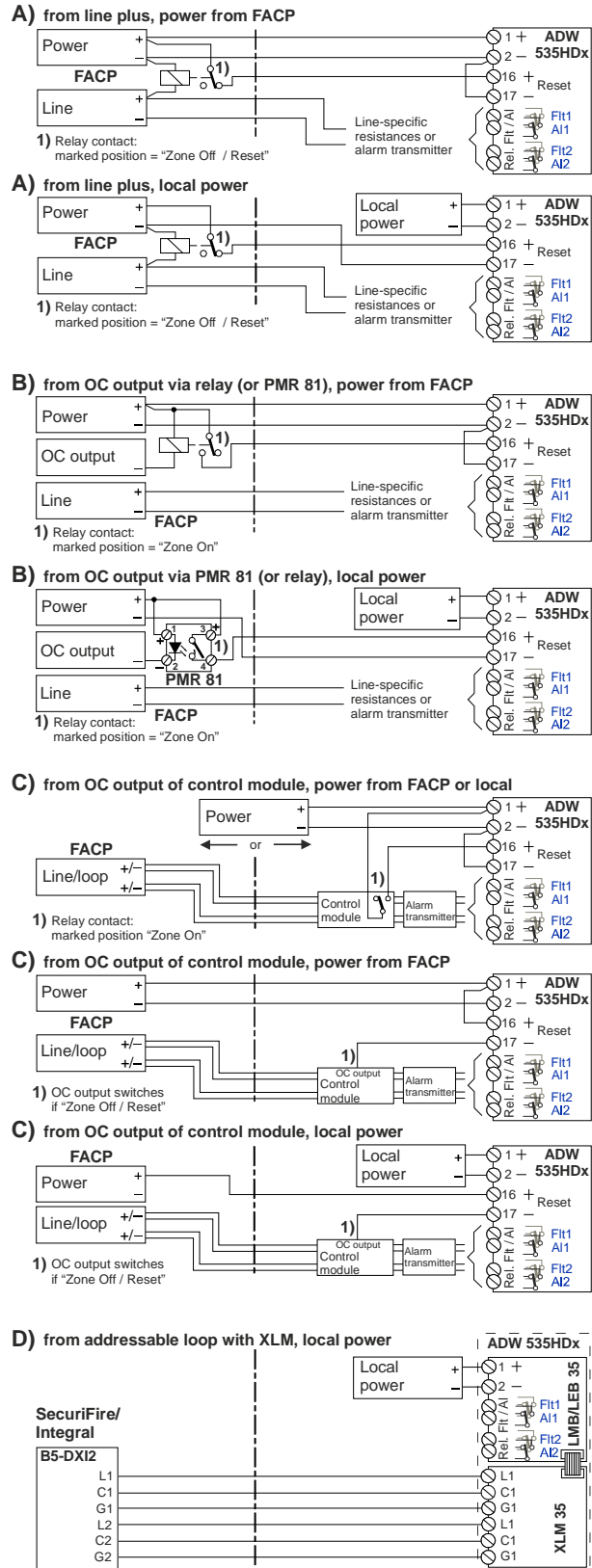

Fig. 25 Control via the “Reset external” input

### 6.5.4 Connection to the FACP line

Each of the following examples illustrates the control via reset input according to Sec. 6.5.3.2. If connection with the control via the voltage supply is required, the control circuit in the figures below can be implemented as described in Sec. 6.5.3.1.

#### 6.5.4.1 Connection to zone detection via relay alarm / fault

- For connection to zone detection lines, the control relay is usually actuated from the line plus. The condition, however, is that the line plus also switches for “Zone On/Off” and “Reset” (see Fig. 26, C for an exception).
- Connection as shown in Fig. 26, B), is used exclusively when the FACP line is to operate with **2-detector dependency (V-AI / H-AI)** from sensing tube I and II. For that purpose the FACP line is programmed for 2-detector dependency. Both sensing tubes of the ADW then cover the **same monitored area**.
- When connecting as shown in Fig. 26, C), Alarm I and Alarm II can be evaluated in the FACP as independent zones from two independent monitoring areas. A **2-line dependency** can also be programmed in the FACP. Then the same applies as under B): both sensing tubes from a monitored area.
- If the connection as in Fig. 26, C) is used, the control signal for the reset input can no longer be picked up from the line plus; instead, a software output has to be created with the following programming:

Line/Zone A or B “Reset”

or:

Line/Zone A and B “Off”

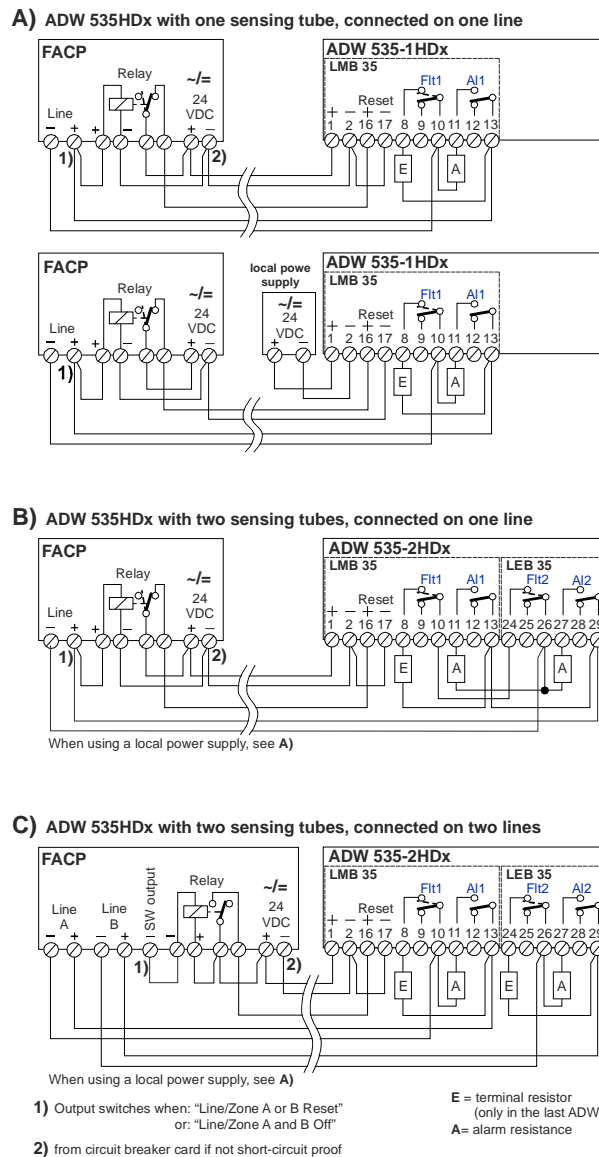

Fig. 26 Connection to zone detection

## Installation

### 6.5.4.2 Connection to selective identification or addressable loop via relay alarm / fault

- With line technologies such as selective identification lines and addressable loops, the control relay is actuated from a software-controlled output (output card or control module). The output is programmed via the FACP software using the “Zone Off” and “Reset” functions.
- If Alarm I and Alarm II are evaluated in the FACP as individual zones (also 2-line dependency), programming of the SW output is as follows:

Output switches when:

Zone A or B “Reset”

or:

Zone A and B “Off”

A normal relay or PMR 81 semi-conductor relay can be used as the control relay.

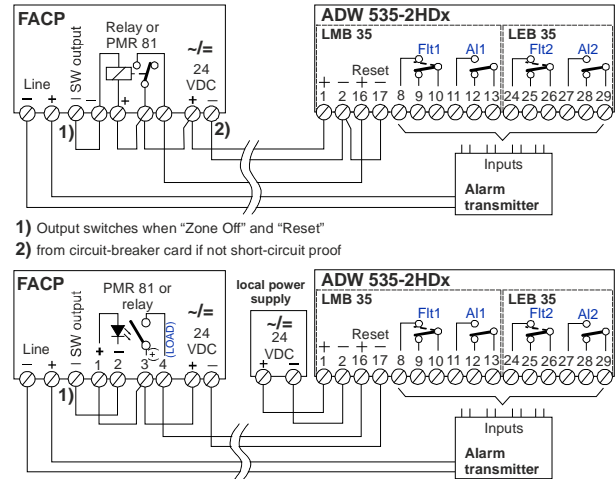

Fig. 27 Connection on selective identification or addressable loop

### 6.5.4.3 Connection to SecuriFire/Integral addressable loop from XLM 35

- For the connection to SecuriFire/Integral addressable loop from the XLM 35 no additional control relay is needed. Likewise, the alarm and fault relays of the ADW 535HDx are not used. The state query and the control of the ADW 535HDx take place directly between the XLM 35 and the addressable loop.
- When using an ADW 535HDx with two sensing tubes and XLM 35 (ADW 535-2HDx), a 2-detector dependency (V-AI / H-AI) can be programmed on the FACP. Evaluation of the individual zones (AI I and AI II) in the FACP is also possible.

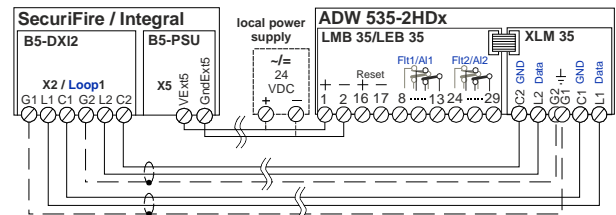

Fig. 28 Connection from XLM 35

Maximum connectible XLM 35 units:

(see also notice below)

For each SecuriFire / Integral addressable loop 62 units ①

① country-specific regulations and guidelines must be observed



### Notices

- The installation of the SecuriFire / Integral addressable loop must be shielded.
- The connection and line routing between **XLM 35** and the SecuriFire and Integral FACP is to be carried out in accordance with **Fig. 28** (L1 to L1, C1 to C1, etc.).
- The **identification sign** (EN 54-17) supplied with the XLM 35 **must** be attached outside on the ADW (next to the ADW rating plate).



### Use in potentially explosive atmospheres

**Caution:** The ADW 535HDx is always energised (24 VDC and SecuriLine) when the SecuriFire / Integral FACP is switched on!

Prior to performing repairs and replacing parts on the ADW 535HDx (printed circuit board, supervising unit), the FACP and the local power (if present) of the ADW 535HDx must be de-energised – the line (loop) deactivated and the 24 VDC power supply of the ADW 535HDx switched off. Before carrying out any interventions on the ADW 535HDx it is necessary to check (measure) that the ADW 535HDx is no longer energised (terminal 1 and 2 or 3 and 4 on the LMB 35, line terminals C1/L1 and C2/L2 on XLM 35).

### 6.5.5 Open collector outputs

The ADW criteria “alarm I”, “alarm II”, “fault I” and “fault II” are available as OC outputs.

Parallel and feedback indicators or other consumers (e.g. relays) can be connected to the OC outputs.

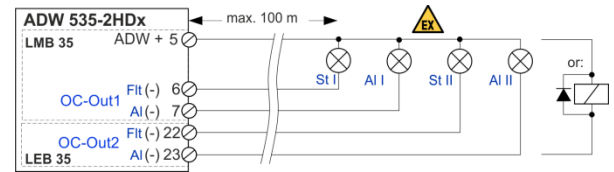

Fig. 29 Connecting the OC outputs



#### Notices

- When connecting inductive consumers (e.g. relays), a free-wheeling diode is to be installed directly at the consumer (**Fig. 29**).
- The outputs are 0-volt switched and have a max. loading capacity of **100 mA** per output. The dielectrical strength per output is 30 VDC. The outputs are short-circuit-proof but not potential-free. Connection to the outputs affects the overall power consumption of the ADW 535HDx.



#### Use in potentially explosive atmospheres

**Important:** only Ex II ATEX approved consumers may be connected in potentially explosive atmospheres.

## Installation

### 6.5.6 External temperature sensor

The ART 535 external temperature sensor is to be used in the following cases (see also Sec. 2.2.12):

- Applications compliant with EN 54-22, Class CI to GI
- Always (for all response grades or applications), as soon as the application temperature in the monitored area deviates more than 20°C from the temperature of the evaluation unit.

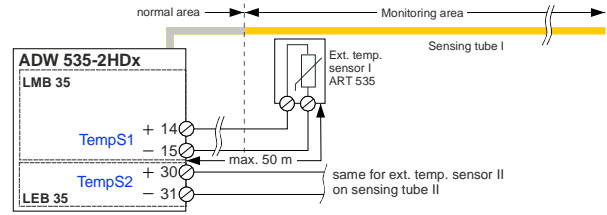

Fig. 30 Connection of external temperature sensor



### Use in potentially explosive atmospheres

The **non-Ex-approved** ART 535 external temperature sensor **is permitted** to be installed in **Ex zones 2 and 22**.

If deployment is necessary in **Ex zones 1 and 21**, the Ex approved temperature sensor **ART 535-30 400 °C / EX 1** or **/ EX 21** is to be used **after consulting with the manufacturer** (see also Sec. 11.1.)

#### Approval:

**ART 535-30 400 °C / EX 1** Ignition protection type “e”: Zone 1, 2 (II 2G Ex em T6)

**ART 535-30 400 °C / EX 21** Ignition protection type “e”: Zone 21, 22 (II 2D Ex mbD A21 IP 65 T80°C)

**Attention:** When using the **ART 535-30 400°C / EX 1** or **/ EX 21** it is **imperative** when mounting to ensure that only the **tip of the sensor** is located in the Ex-zone.

The ART 535 can be remotely located a maximum of 50 m. The following versions of the ART 535 are available:

- ART 535-10 10 m connection cable, use range of sensor and cable up to 200°C
- ART 535-10 / 400°C 10 m connection cable, use range of sensor and cable up to 400°C
- ART 535-30 400°C / EX 1 30 m connection cable, use range of sensor tip up to 400°C
- ART 535-30 400°C / EX 21 30 m connection cable, use range of sensor tip up to 400°C



### Notices

- The ART 535 is to be introduced to the monitored area and positioned so that it is optimally exposed to the local ambient temperatures.
- Position the ART 535 so that it is not exposed to direct sunlight.
- For temperature ranges over 200°C use the ART 535-10 / 400 °C version.



### Notices

- The feed line to the ART 535 can be a commercially available installation cable with a cross-section of 0.5 mm<sup>2</sup>. As soon as the feed line is routed into the increased temperature area, a heat resistant cable may have to be used, depending on the response grade.
- The polarity (+ /-) of the connection must be observed.
- If both sensing tubes are located in the same climate zone (identical application temperature in both monitored areas), **one** external temperature compensation is sufficient (can be parameterised via “ADW Config” configuration software).

## 7 Commissioning

### 7.1 General



#### Notices

The following points must be observed when commissioning the ADW 535HDx:

- The ADW 535HDx is to be commissioned by trained and qualified personnel only.
- Prior to commissioning it must be ensured that, after mounting, the entire sensing tubing has been blown out with compressed air and/or nitrogen (see also Sec. 5.4.2.5).
- Prior to commissioning, an inspection of the mounting and installation must ensure that when the power supply is switched on there can be no damage to the ADW 535HDx.
- Rewiring the device may be performed only when voltage is disconnected.
- Before switching on, any additional modules are to be fitted in the evaluation unit and connected to the LMB 35 main board using the supplied ribbon cable. See also Sec. 6.3.
- Before switching on the ADW power supply, ensure that all fire incident controls and remote alerting from the ADW 535HDx are blocked or deactivated.
- Immediately before switching on the ADW 535HDx for the first time, remove the isolating strip from the lithium battery (LMB 35).
- When commissioning, it is essential to perform an initial reset with integrated venting of the sensing tubing (for each sensing tube). This automatically also performs the required sealing check of the sensing tube.
- When performed via “ADW Config”, the initial reset is always carried out with activated “sealing check” and “length check” (always activated from *EasyConfig*).



#### Use in potentially explosive atmospheres

When using the ADW 535HDx in potentially explosive atmospheres, the following additional points must be observed:

- Prior to commissioning this operating material, the tests named in the individual national provisions must be performed.
- In addition, prior to commissioning it is necessary to check that the operating material is correctly installed and functions properly as specified in this technical description and applicable regulations.
- This operating material may be operated only when closed.

#### 7.1.1 Connect ADW 535HDx via Ethernet with “ADW Config”

IP address **169.254.1.1** is programmed on every ADW 535HDx at the factory. No changes to the Ethernet settings of the PC are necessary if the IP address is obtained automatically.

A connection is established as follows:

1. connect PC and ADW 535HDx using an Ethernet cable (point to point), see also Sec. 7.1.1.1);
2. wait until the PC has assigned an IP address in the **169.254.x.x** range (this may take up to 1 min) (see also Sec. 7.1.1.2);
3. establish a connection to the ADW 535HDx with “ADW Config” (see also Sec. 7.1.1.3).

If the ADW 535HDx is to be used in an existing network or if an IP address range outside **169.254.x.x** is wanted, refer to Sec. 7.1.1.1 to 7.1.1.3 for help. This also applies to problems when establishing connections.



#### Notice

It is the responsibility of the system operator and/or user of the special fire detector system to ensure IT security.

### 7.1.1.1 Topology of the connection between ADW 535HDx and PC

For initial commissioning, the ADW 535HDx is connected point-to-point to the PC using an Ethernet cable.

If the ADW 535HDx is intended to function as part of an ADW network (see Sec. 11.2.2) or is to be integrated into an existing network, ensure that all participants have a unique IP address; this is because all ADW 535HDx units are pre-configured ex works with the same IP address.

### 7.1.1.2 Adjust configuration on the PC

In order for the PC to establish a connection to the ADW 535HDx, it must be in the same subnet as the ADW 535HDx. On an ADW 535HDx ex works, the PC settings must also be set to "Automatic"; the connection can then be established.

#### Configuration with automatic IP address

With administrator rights and the following work steps, the IP configuration can be set to "Automatic":

1. via "**System control**" call up "**LAN connection**" (under "**Network and Internet**" or "**Network and enable centre**" > "**Change adapter settings**") and open "**Properties**" by right clicking it;
2. mark the element "**Internet protocol version 4 (TCP/IPv4)**" and open "**Properties**";
3. in the "**General**" tab, "**IP address**" and the "**DNS server address**" should be set to "**Obtain automatically**";
4. in the "**Alternative configuration**" tab, "**Automatically assigned private IP address**" should be set.

#### Configuration with fixed IP address

If you want a fixed IP address, proceed as follows:

1. via "**System control**" call up "**LAN connection**" (under "**Network and Internet**" or "**Network and enable centre**" > "**Change adapter settings**") and open "**Properties**" by right clicking it;
2. mark the element "**Internet protocol version 4 (TCP/IPv4)**" and open "**Properties**";
3. in the "**General**" tab, the "**IP address**" should be set to the desired value or left unchanged;
4. the "**DNS server address**" is not necessary for operating the ADW 535HDx; leave empty if uncertain.

#### Configuration with temporary alternative IP address

If an IP address outside the range **169.254.x.x** is selected, connecting to the ADW 535HDx will no longer be possible. This is because the two participants are in different subnets. To solve this issue, an alternative IP configuration that allows access to the range **169.254.x.x** can be defined temporarily in the PC configuration. To do so proceed as follows:

1. via "**System control**" call up "**LAN connection**" (under "**Network and Internet**" or "**Network and enable centre**" > "**Change adapter settings**") and open "**Properties**" by right clicking it;
2. mark the element "**Internet protocol version 4 (TCP/IPv4)**" and open "**Properties**";
3. in the "**General**" tab via the "**Advanced...**" button call up the "**Advanced TCP/IP Settings**" dialogue;
4. open the "**TCP/IP address**" dialogue with the "**Add...**" button and enter the following configuration:
  - IP address: 169.254.1.2
  - Subnet mask: 255.255.0.0

Thanks to this alternative configuration the IP address of the ADW 535HDx can be changed without a temporary loss of connection. The alternative configuration can then of course be deleted once it is no longer needed.

### 7.1.1.3 Adjust IP address on the ADW 535HDx

If needed, any IP address can be assigned to the ADW 535HDx with the “ADW Config” configuration software. To do so, specify the IP address, subnet mask, and a requisite gateway in “ADW Config” via the menu item “**Connection**” > “**Edit address**”.

The following IP addresses or ranges are excluded and detected by “ADW Config”:

- 0.0.0.0/8
- 127.0.0.0/8
- 255.255.255.255

The same restrictions also apply to the gateway. The subnet is not subject to restrictions detected by “ADW Config”.

**Important:** An address assignment **outside** the PC subnet results in a disconnection between “ADW Config” and the ADW 535HDx. To re-establish the connection in the required address range, the network settings on the PC must be adjusted, or the alternative configuration described in Sec. 7.1.1.2 must be used.



#### Notice

If required, it is possible to reset the IP address to the factory setting **169.254.1.1** on the ADW 535HDx with **EasyConfig**, switch position **N** > **SE** > **FSE** (see Sec. 7.6.2).

### 7.2 Programming

The ADW 535HDx has several switch positions that are configured with permanently assigned parameters:

- Response behaviour acc. to **EN 54-22**, classes **A11** to **GI**, → **C > A1** to **G** → ①;
- Response behaviour acc. to **NFPA 72**, classes **Ordinary**, **Intermediate**, **High**, → **C > No, NI, NH** (every 30 ft **Spacing**);
- Response behaviour for road tunnels according to **RVS (AT)**, → **C > T1**;
- Response behaviour for road tunnels according to **KFI (KR)**, → **C > T2 (T3** for laboratory tests “**Class A**”);
- Normative system limits (EN 54-22) concerning sensing tube monitoring, → **C > W00** to **W03**;
- Non-normative system limits (EN 54-22) concerning sensing tube monitoring, → **C > W04** to **W09**;
- Configurable switch positions **X01** to **X03** for saving the settings after using “ADW HeatCalc” and/or changing the device configuration using the “ADW Config” configuration software.



#### Notice

- ① Switch positions **A1–** and **A2–** are oriented to classes A11 and A2I for space surveillance according to EN 54-22, but without detection properties for test fire TF6 **slow**. If slowly developing fires are **not** to be taken into consideration in an application, these switch positions can be used **after consulting with the manufacturer**.  
**Caution:** These switch positions may **not be used for the comprehensive requirements of EN 54-22**.

A detailed description of all switch positions is in Sec. 8.3.

If the ADW 535HDx is operated with **EasyConfig**, i.e. within the pre-set system limits according to the tables in Sec. 4.5.1.1 and 4.5.1.2, select only switch positions **C > A1** to **T3** and **W01** to **W09**; it is not necessary to use the “ADW Config” configuration software to do so.

For systems where the “ADW HeatCalc” calculation software was used for planning, the results calculated by “ADW HeatCalc” are to be programmed by means of a handover file via the “ADW Config” configuration software on the ADW 535HDx. The data is saved on the ADW 535HDx under one of the freely configurable switch positions **X01** to **X03**. The ADW 535HDx is then operated on the corresponding switch positions **X01** to **X03**.

The device ships with default values already stored under switch positions **X01** to **X03**. Specifically:

- position **X01** of position **A1**;
- position **X02** of position **b**;
- position **X03** of position **C**.

### 7.2.1 Configuration options

A number of parameters can be configured with the “ADW Config” configuration software:

- Diff and Max alarm response sensitivity
- Alarm verification (delta and time)
- Trigger thresholds for pre-signals 1, 2 and 3 (individually, for each sensing tube)
- Delay times for Diff pre-signal, Max pre-signal, Diff alarm, Max alarm and fault (individually)
- Sensitivity and delay time of the sensing tube monitoring
- Deactivate latching for Diff pre-signal, Max pre-signal, Diff alarm, Max alarm and fault (individually)
- Deactivate criteria (pre-signals, alarms, faults)
- Date/time
- Day/night operation
- Relay assignment (RIM 36)
- Other

Notice

The parameters are configured and stored ex works with default states and values to meet norm-compliant triggering required by EN 54-22 / NFPA 72 / RVS / KFI. Changing the parameters may result in non-compliance with EN 54-22. Any adjustments or modifications to the ADW 535HDx via “ADW Config” may be performed only by the manufacturer or by qualified personnel instructed and trained by the manufacturer.

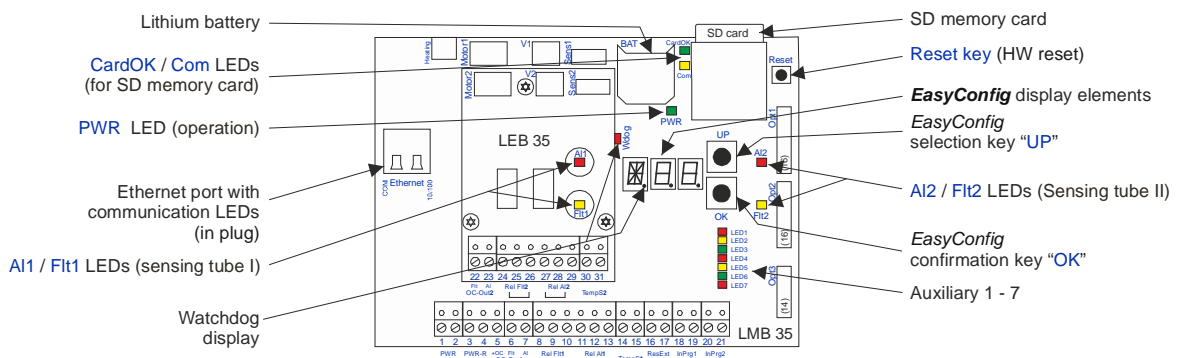

Fig. 31 Operation and display elements on the LMB 35

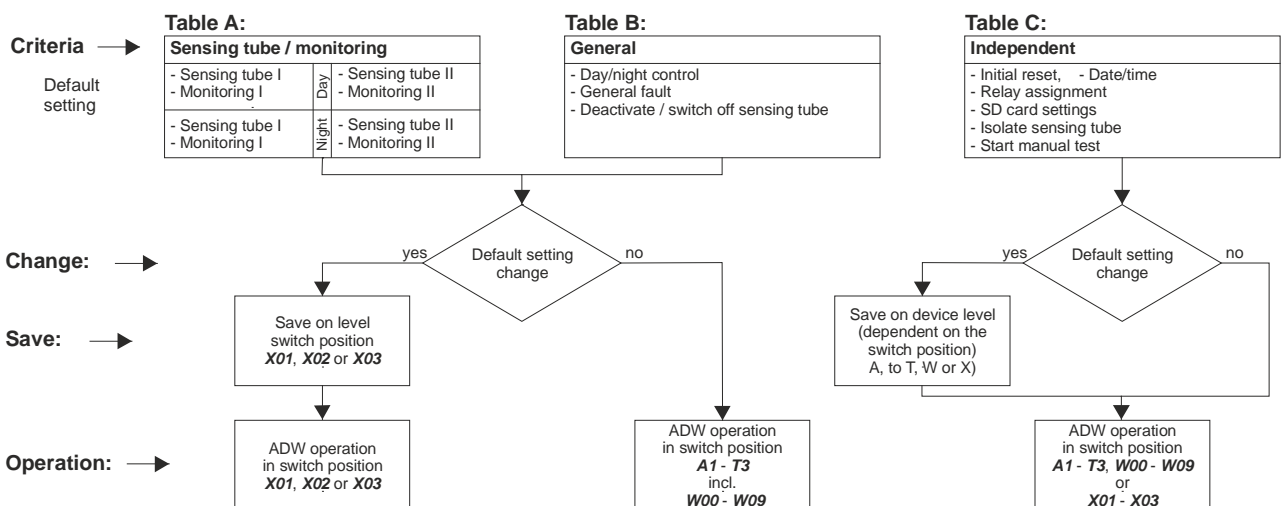

Fig. 32 Configuration overview

## Commissioning

**Table A:** The following criteria can be set for each sensing tube. Also, the criteria for day/night control can be separately set. Configuration changes are saved on one of the freely programmable switch positions **X01** to **X03** using “ADW Config”.

Sector	Default setting	Area	Resolution / levels	Saving after change
• Parameter				
<b>Sensing tube parameters (length / outer diameter)</b>				
• Supply line “A” (see also Fig. 8)	5 m	0 – 20 m	1 m	<b>X01 – X03</b>
• Supply line, inner diameter	3 mm	3 – 4 mm	1 mm	<b>X01 – X03</b>
• ① Monitored area “C” (see also Fig. 8)	110 m	10 (> “A”) – 200 m	1 m	<b>X01 – X03</b>
• Monitored area, inner diameter	4 mm	---	---	<b>X01 – X03</b>
<b>Alarm (EN 54-22 / NFPA 72 / RVS / KFI)</b>				
• ① Diff alarm status (On/Off)	On	On / Off ②		<b>X01 – X03</b>
• ① Diff alarm threshold (dependent on sensing tube length and the response grade according to EN 54-22 / NFPA 72 / RVS / KFI)	<b>A1</b>	0.5 to 250 mbar/min.	0.1 mbar/min.	<b>X01 – X03</b>
• ① Diff alarm verification status (On/Off)	On	On / Off		<b>X01 – X03</b>
• ① Diff alarm verification delta pressure value	<b>A1</b>	1 – 100 mbar	0.1 mbar	<b>X01 – X03</b>
• ① Diff alarm verification time	600 s	60 s – 1,200 s	1 s	<b>X01 – X03</b>
• ① Diff alarm delay	4 s	0 s – 30 s	1 s	<b>X01 – X03</b>
• Diff alarm latching	On	On / Off		<b>X01 – X03</b>
• ① Max. alarm status (On/Off)	On	On / Off ②		<b>X01 – X03</b>
• ① Max. alarm threshold (dependent on sensing tube length and the response grade according to EN 54-22 / NFPA 72 / RVS / KFI)	<b>A1</b>	1 – 1,200 mbar	0.1 mbar	<b>X01 – X03</b>
• ① Max. alarm delay	4 s	0 s – 30 s	1 s	<b>X01 – X03</b>
• Max. alarm latching	On	On / Off		<b>X01 – X03</b>
• ① Adjustment (compensation), On/Off	On	On / Off		<b>X01 – X03</b>
• Adjustment (compensation), temp. sensor selection	Internal	Int./Ext. I / Ext. II		<b>X01 – X03</b>
• Adjustment (compensation), interval	60 min	1 – 1,440 min	1 min	<b>X01 – X03</b>
• Ext. alarm temp. sensor	Off	55 – 300 °C	1 °C	<b>X01 – X03</b>
• Ext. alarm temp. sensor, delay	2 s	0 s – 30 s	1 s	<b>X01 – X03</b>
• Ext. alarm temp. sensor, latching	On	On / Off		<b>X01 – X03</b>
<b>Pre-signal</b>				
• Pre-signal Diff alarm On/Off	Off	off / on		<b>X01 – X03</b>
• Pre-signal Max alarm On/Off	Off	off / on		<b>X01 – X03</b>
• Pre-signal Diff alarm (100% = alarm threshold)	---	5 – 95%	5%	<b>X01 – X03</b>
• Pre-signal Max alarm (100% = alarm threshold)	---	5 – 95%	5%	<b>X01 – X03</b>
• Pre-signal delay (Diff and Max)	4 s	0 s – 30 s	1 s	<b>X01 – X03</b>
• Pre-signal latching (Diff and Max)	Off	On / Off		<b>X01 – X03</b>
<b>Sensing tube monitoring / test</b>				
• ① Sensing tube monitoring EN 54-22 On/Off	On	On / Off		<b>X01 – X03</b>
• Sensing tube monitoring cyclic On/Off	On	On / Off		<b>X01 – X03</b>
• Test through monitoring (EN) / cyclic ③	Monit. + cycl.	Monit. + cycl.		<b>X01 – X03</b>
• Test interval	24 h	1 – 48 h	1 h	<b>X01 – X03</b>
• Test sensitivity	Medium	Low / medium / high	3	<b>X01 – X03</b>
• Self-test repetition rate ③	2 ③	1 – 4	1	<b>X01 – X03</b>
• Testing waiting time ③	30 min ③	1 – 60 min	1 min	<b>X01 – X03</b>



### Notices

- ① **Changes** to these parameters have an effect on the response characteristics of the ADW 535HDx and can mean that the requirements **according to EN 54-22 / NFPA 72 / RVS / KFI are no longer met**. Any adjustments or modifications to the ADW 535HDx via “ADW Config” may be performed only by the manufacturer or by qualified personnel instructed and trained by the manufacturer.
- ② Diff alarm status “Off” / Max alarm status “Off”; both criteria cannot be switched off at the same time.
- ③ Valid for **C > A1** to **G** and **W00** to **W03**. Increased values are configured for switch positions **W04** to **W09** that are not tested in accordance with EN 54-22 (see Sec. 4.5.1.2).

**Table B:** The following criteria apply to the entire ADW 535HDx. Configuration changes are stored in connection with the adjustments from Table A, likewise on one of the user configurable switch positions **X01** to **X03**.

Sector • Parameter	Default setting	Area	Resolution / levels	Saving after change
<b>Day/night control &amp; weekday control</b>				
• ① Day/night control On/Off	Off	Off / clock / FACP		<b>X01 – X03</b>
• Day start time	06:00	00:00 – 24:00	1 min	<b>X01 – X03</b>
• Night start time	20:00	00:00 – 24:00	1 min	<b>X01 – X03</b>
• Weekday control	On	Mon to Sun	Days	<b>X01 – X03</b>
<b>General faults</b>				
• Lithium battery / clock fault	On	On / Off		<b>X01 – X03</b>
<b>Deactivate / switch off sensing tube</b>				
• ① Switch off sensing tube I / sensing tube II (partial planning) only sensing tube II	On	On / deactivated / switched off (partial planning)		<b>X01 – X03</b>

① See note **Table A**

**Table C:** Independent configurations. These can be changed regardless of the switch position in the ADW 535HDx.

Sector • Parameter	Default adjustment	Selection
<b>Clock</b>		
• Year, month, day, hour, minute, second	---	Seconds – year
<b>Relay / OC output / reset key / various</b>		
• Relay 1, 1 <sup>st</sup> RIM 36	Diff alarm of sensing tube I	According to Sec. 7.2.2
• Relay 2, 1 <sup>st</sup> RIM 36	Max alarm of sensing tube I	According to Sec. 7.2.2
• Relay 3, 1 <sup>st</sup> RIM 36	Diff alarm pre-signal of sensing tube I	According to Sec. 7.2.2
• Relay 4, 1 <sup>st</sup> RIM 36	Max alarm pre-signal of sensing tube I	According to Sec. 7.2.2
• Relay 5, 1 <sup>st</sup> RIM 36	Alarm LMB temperature sensor	According to Sec. 7.2.2
• Relay 1, 2 <sup>nd</sup> RIM 36	Diff alarm of sensing tube II	According to Sec. 7.2.2
• Relay 2, 2 <sup>nd</sup> RIM 36	Max alarm of sensing tube II	According to Sec. 7.2.2
• Relay 3, 2 <sup>nd</sup> RIM 36	Diff alarm pre-signal of sensing tube II	According to Sec. 7.2.2
• Relay 4, 2 <sup>nd</sup> RIM 36	Max alarm pre-signal of sensing tube II	According to Sec. 7.2.2
• Relay 5, 2 <sup>nd</sup> RIM 36	Freely programmable	According to Sec. 7.2.2
• Logging interval of SD memory card	1 s	1 – 120 s
• Perform initial reset, sensing tube I	---	On/Off
• Perform initial reset, sensing tube II	---	On/Off
• Manually initiate testing, sensing tube I	---	On/Off
• Manually initiate testing, sensing tube II	---	On/Off
• Isolate sensing tube (sensing tube I / II)	Normal operation	Isolate / normal operation

## 7.2.2 Relay allocation

The following criteria are freely programmable on max. 10 relays (5 units on 1<sup>st</sup> RIM 36, 5 units on 2<sup>nd</sup> RIM 36):

Sensing tube I	Sensing tube II	General
Diff alarm, sensing tube I	Diff alarm, sensing tube II	Alarm temperature sensor LMB
Max alarm, sensing tube I	Max alarm, sensing tube II	Undervoltage fault
Diff alarm pre-signal, sensing tube I	Diff alarm pre-signal, sensing tube II	Clock fault
Max alarm pre-signal, sensing tube I	Max alarm pre-signal, sensing tube II	
Pressure sensor I fault	Pressure sensor II fault	
Test unit I fault	Test unit II fault	
Fault ext. temperature sensor I	Fult ext. temperature sensor II	

The criteria can also be allocated with the “or” function (example: sensing tube I interruption or sensing tube II interruption together on one relay).

## 7.3 Starting up

The information on operation and display elements necessary for startup can be found in **Fig. 31**.



### Notice

Before the ADW 535HDx is switched on, all the precautions required for operation as described in Sec. 7.1 must be fulfilled.

### 7.3.1 Commissioning with EasyConfig

The workflow for commissioning with **EasyConfig** is shown below (planning without “ADW HeatCalc” calculation, without “ADW Config” configuration software). When RIM 36 additional modules are fitted, the RIM relays respond as indicated in Sec. 2.2.5 and Sec. 7.2.1, Table C. The default values as set out in Sec. 7.2.1 also apply to all other settings.

#### Commissioning workflow using EasyConfig

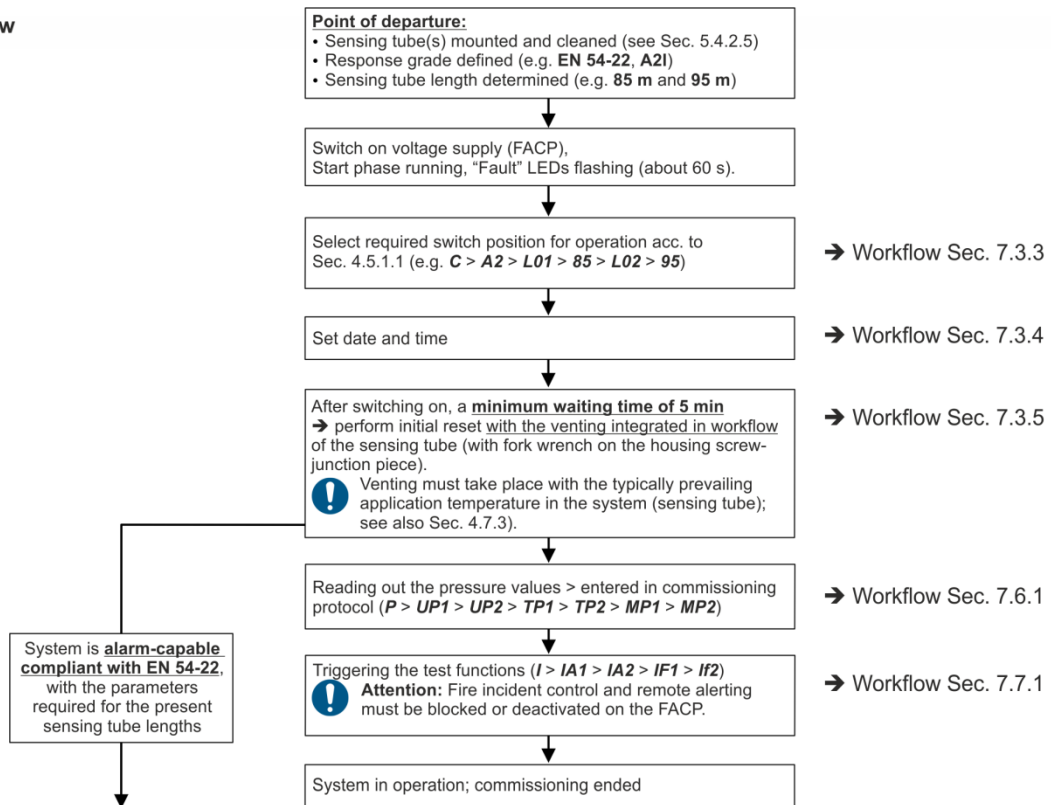

**Fig. 33 Workflow for commissioning using EasyConfig**

### 7.3.2 Commissioning with “ADW Config” configuration software

The workflow for commissioning when using the “ADW Config” configuration software is shown below. The “ADW Config” configuration software is required only if changes have to be made to the default configuration profile (Sec. 7.2.1) or if the “ADW HeatCalc” calculation software has been used.

#### Commissioning workflow using “ADW Config” configuration software

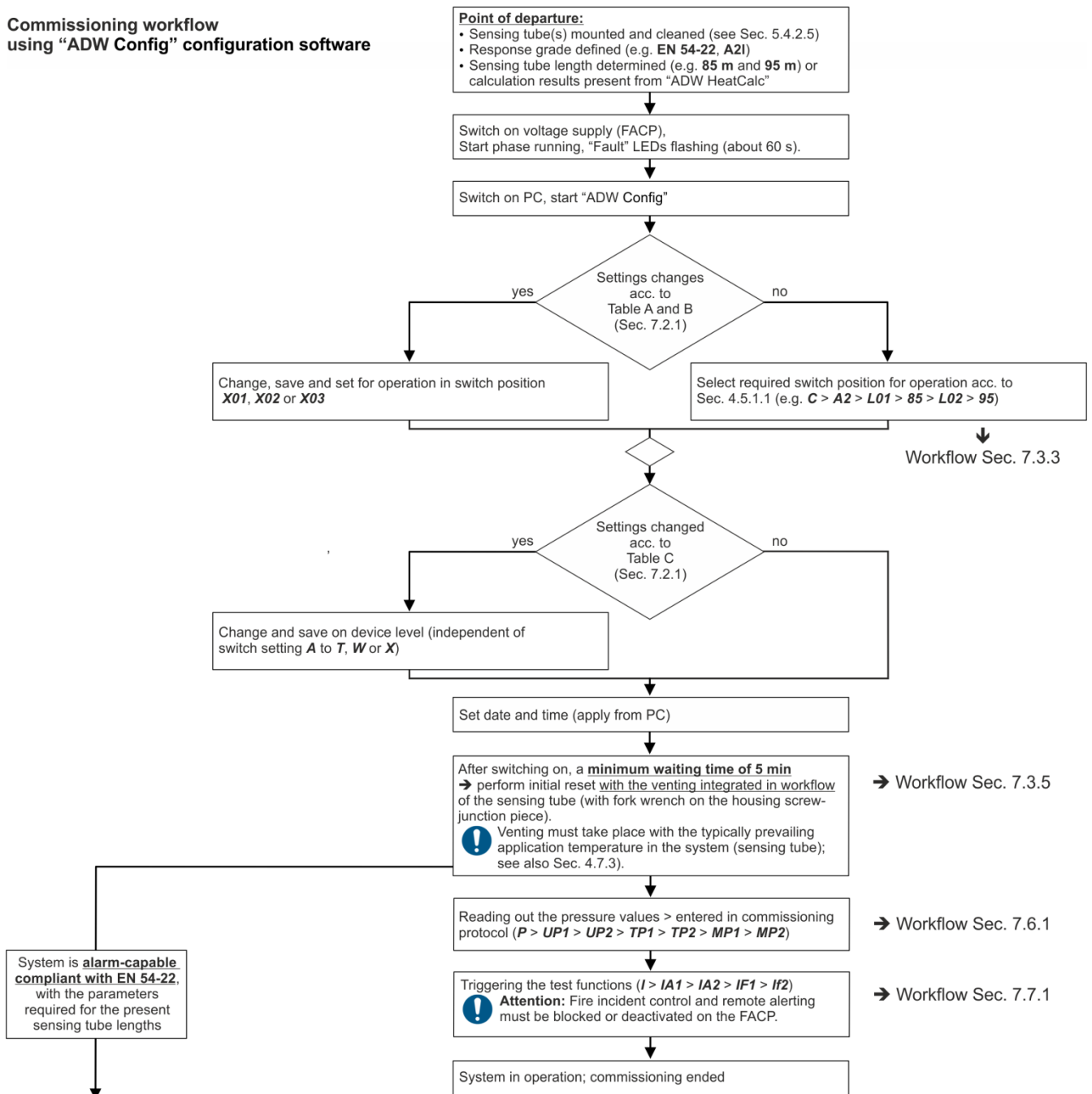

Fig. 34 Workflow for commissioning with “ADW Config” configuration software













## 7.3.3 Setting to pre-defined switch positions A1 to T3, W00 to W09

The following workflow describes the procedure when the ADW 535HDx must be set to one of the permanently configured switch positions **C** > **A1** to **T3** and possibly also to a modified sensing tube monitoring **W01** to **W09**. It should be noted that the positions **W04** to **W09** result in **non-normative** sensing tube monitoring according to EN 54-22.

**Example: (first part of the table)** ADW 535-2HDx (with 2 sensing tubes) should respond compliant with EN 54-22, Class **A21**. The sensing tubes have different lengths: sensing tube **I** = **85 m**, sensing tube **II** = **95 m**. Switch position **C** > **A2** is to be selected as specified in Sec. 4.5.1.1.

The **second part of the table** shows how the sensing tube monitoring can be subsequently changed, here as an example to the **non-normative** setting **W04**.

### First part:









Measure	Display	Procedure / remarks
(1)  Press key	Flashing <b>A1</b> > <b>W00</b> > <b>L01</b> > <b>115</b> > <b>L02</b> > <b>115</b> (in sequence)	• Displays the <b>Default</b> setting
(2)  Press key again until display on <b>C</b>	In sequence <b>A1</b> / <b>C</b>	• Displays switch position group <b>C</b>
(3)  Press key	<b>A1</b>	• Displays class selection <b>A1</b> in group <b>C</b>
(4)  Press key until display on <b>A2</b>	Stepwise, <b>A1</b> / <b>A2</b> to <b>W</b> (possible selection here: <b>A1</b> / <b>A2</b> / <b>A1-</b> (Ⓢ) / <b>A2-</b> (Ⓢ) / <b>b</b> / <b>C</b> / <b>d</b> / <b>E</b> / <b>F</b> / <b>G</b> / <b>No</b> / <b>NI</b> / <b>NH</b> / <b>T1</b> / <b>T2</b> / <b>T3</b> / <b>W</b> )	• Displays class selection <b>A2</b> in group <b>C</b> (Ⓢ)
(5)  Press key	<b>L01</b>	• Displays entry mode for length <b>sensing tube I</b>
(6)  Press key	<b>015</b>	• Displays the minimum sensing tube length = <b>15 m</b>
(7)  Press the key several times until display on <b>085</b> (= 85 m)	Stepwise, <b>015</b> / <b>020</b> / <b>025</b> to <b>085</b>	• Displays the possible sensing tube length in 5 m steps
(8)  Press key	<b>L02</b>	• Displays entry mode for length <b>sensing tube II</b>
(9)  Press key	<b>015</b>	• Displays the minimum sensing tube length = <b>15 m</b>
(10)  Press the key several times until display on <b>095</b> (= 95 m)	Stepwise, <b>015</b> / <b>020</b> / <b>025</b> to <b>095</b>	• Displays the possible sensing tube length in 5 m steps
(11)  Press key	Flashing - - - (approx. 4 x)	• New setting is programmed
(12)  Press key to check the change	Flashing <b>A2</b> > <b>W00</b> > <b>L01</b> > <b>085</b> > <b>L02</b> > <b>095</b> (in sequence)	• <b>Displays the new setting:</b> • <b>Normative alarm release</b> • <b>Normative sensing tube monitoring</b>

Ⓢ Switch positions **A1-** and **A2-** are oriented to classes A1I and A2I for space surveillance according to EN 54-22, but without detection properties for test fire TF6 [slow](#). If slowly developing fires are **not** to be taken into consideration in an application, these switch positions can be used **after consulting with the manufacturer**. **Caution:** These switch positions may **not be used for the comprehensive requirements of EN 54-22**.

For response-class-related use of the ADW 535, the information in the Sec. 4.1.1 must be observed.

→→ (continuation)

## Second part (continuation)

 <b>Notice</b>		
Switch positions <b>W04</b> to <b>W09</b> may be used only after consulting with the manufacturer. The configured values they contain concerning sensing tube monitoring are <b>not</b> tested in accordance with EN 54-22 ( <b>W00</b> = default).		
Measure	Display	Procedure / remarks
(13)  Press key	Flashing <b>A2 &gt; W00 &gt; L01 &gt; 085 &gt; L02 &gt; 095</b> (in sequence)	<ul style="list-style-type: none"> <li>• Display in the first part of the switch position</li> </ul>
(14)  Press key again until display on <b>C</b>	In sequence <b>A2 / C</b>	<ul style="list-style-type: none"> <li>• Displays switch position group <b>C</b></li> </ul>
(15)  Press key	<b>A1</b>	<ul style="list-style-type: none"> <li>• Displays class selection <b>A1</b> in group <b>C</b></li> </ul>
(16)  Press key until display on <b>W</b>	Stepwise, <b>A1 / A2</b> to <b>W</b> (possible selection here: <b>A1 / A2 / A1- (⓪) / A2- (⓪) / b / C / d / E / F / G / No / NI / NH / T1 / T2 / T3 / W</b> )	<ul style="list-style-type: none"> <li>• Displays submenu <b>W</b> in group <b>C</b></li> </ul>
(17)  Press key	<b>W00</b> (= default)	<ul style="list-style-type: none"> <li>• Selection of the switch position <b>W00</b></li> </ul>
(18)  Press key several times until display on <b>W04</b>	Stepwise, <b>W00 / W01</b> to <b>W04</b>	<ul style="list-style-type: none"> <li>• Selection of the switch position <b>W04</b></li> </ul>
(19)  Press key	Flashing - - - (approx. 4 x)	<ul style="list-style-type: none"> <li>• New setting is programmed</li> </ul>
(20)  Press key to check the change	Flashing <b>A2 &gt; W04 &gt; L01 &gt; 085 &gt; L02 &gt; 095</b> (in sequence)	<ul style="list-style-type: none"> <li>• <b>Displays the new setting:</b></li> <li>• <b>Sensing tube monitoring <u>not</u> normative</b></li> <li>• <b>Normative alarm release</b></li> </ul>

- ① Switch positions **A1-** and **A2-** are oriented to classes A1I and A2I for space surveillance according to EN 54-22, but without detection properties for test fire TF6 **slow**. If slowly developing fires are **not** to be taken into consideration in an application, these switch positions can be used **after consulting with the manufacturer**. **Caution:** These switch positions may **not be used for the comprehensive requirements of EN 54-22**.

For response-class-related use of the ADW 535, the information in the Sec. 4.1.1 must be observed.

## 7.3.4 Setting and polling the date and time

The following describes the procedure for setting the date and time.

**Example:** Setting on 10 June 2016; 11:05:30

Measure	Display	Procedure / remarks
(21)  Press key	Flashing <b>A1 &gt; L01 &gt; 115 &gt; L02 &gt; 115</b> (in sequence), or other	• Display of the <b>default</b> setting or the installation-specific switch setting
(22)  Press the key several times until display on <b>T</b>	In sequence <b>A1 / C / E / F / I / N / o / P / R / S / T</b>	• Displays the switch position group <b>T</b>
(23)  Press key	<b>RE</b> ①	• Date/time display, polling mode ①
(24)  Press key until display on <b>SE</b>	In sequence <b>RE / SE</b>	• Date/time display, input mode
(25)  Press key	<b>Y13</b>	• Displays the year 2013 (example)
(26)  Press key until <b>Y16</b>	<b>Y16</b>	• Selected year 2016
(27)  Press key > Month	<b>M01</b>	• Displays the month of January
(28)  Press key until <b>M06</b>	<b>M06</b>	• Selected month June
(29)  Press key > Day	<b>d01</b>	• Displays the first day of the month
(30)  Press key until <b>d10</b>	<b>d10</b>	• Selected day is 10
(31)  Press key > Hour	<b>H00</b>	• Displays hour 00
(32)  Press key until <b>H11</b>	<b>H11</b>	• Selected hour is 11
(33)  Press key > Minute	<b>M00</b>	• Displays minute 00
(34)  Press key until <b>M05</b>	<b>M05</b>	• Selected minute is 05
(35)  Press key > Second	<b>S00</b>	• Displays second 00
(36)  Press key until <b>S30</b>	<b>S30</b>	• Selected second 30
(37)  Press the key, date and time are programmed	Flashing --- (approx. 2 x)	• The date is set to 10.06.2016, and the clock starts to run from the time 11:05:30

### Notice



#### ① Poll date and time:

In the **T > RE** switch position, pressing "OK" outputs the currently set date and the current time on the ADW 535HDx.

**Example:** In sequence **Y16 > M06 > d10 > H11 > M05 > S57**.

7.3.5 Initial reset

When commissioning the ADW 535HDx, for each sensing tube an initial reset is necessary → to acquire the basic data (nominal values) based on the connected sensing tube volume switch positions **U01** and **U02**.

An initial reset does not discard the system-specific parameters (response grade).

**Notices**

- The initial reset must always be performed under the system's "normal conditions", i.e. if possible, under the normal operating temperature of the sensing tube (see also Sec. 4.7.3). When this is performed, no temperature changes occur.
- The initial reset must take place when the **ADW housing is open**.
- If there is an expansion, conversion, retrofitting or repair on the sensing tube, an initial reset is imperative. An initial reset must also be carried out after repair work on the ADW 535HDx (replacement of the LSU 35 supervising unit, LMB 35 main board).
- After a FW upgrade, an initial reset is required only if expressly mentioned in the relevant firmware description.
- When performed via "ADW Config", the initial reset is always carried out with activated "sealing check" and "length check" (always activated from **EasyConfig**).

Measure	Display	Procedure / remarks
(1)  Press key	Flashing <b>A1 &gt; L01 &gt; 115 &gt; L02 &gt; 115</b> (in sequence), or other	• Display of the <b>default</b> setting or the installation-specific switch setting
(2)  Press the key several times until display <b>U</b>	In sequence <b>A1 / C / E / F / I / N / o / P / R / S / T / U</b>	• Displays the switch position group <b>U</b>
(3)  Press key	<b>U01</b>	• Displays initial reset On for <b>sensing tube I</b>
(4)  Press the key several times until display <b>U01</b>	In sequence <b>U01 / U02</b>	• Selection of switch position <b>U01</b> , initial reset On with sealing check for <b>sensing tube I</b>
(5)  Press the key again	static <b>U</b> , flashing <b>01</b>	• <b>Start position</b> ; the step motor goes into start position, pressure pump is fully wound.
(6) <b>Vent sensing tube</b> → open screw-junction piece on the hose for 60 s and then <b>firmly close</b>	static <b>U</b> , flashing <b>01</b>	• A <b>pressure compensation</b> takes place to "O" in the sensing tube
(7)  Press the key again  Automatic procedure (if fault → cancel)	Flashing <b>U01</b>          Flashing --- ①	<ul style="list-style-type: none"> <li>• <b>Initial reset pressure</b>; the step motor starts up and generates the initial reset pressure dependent on the sensing tube length (nominal value, takes about <b>30 s</b>)</li> <li>• <b>Leakage analysis and length check</b>; comparison of the connected sensing tube length based on the initial reset pressure. If discrepancy → initial reset fault → initial reset cancelled</li> <li>• <b>Temp. stability</b>; the pressure measured in sensing tube I (no over- or underpressure) is observed for approx. <b>30 s</b> to check for temperature changes.</li> <li>• <b>Pressure build-up</b>; the step motor starts and creates overpressure in sensing tube I</li> <li>• <b>Sealing check</b>; the overpressure in sensing tube I is observed for about <b>30 s</b>. If pressure drop → initial reset fault</li> <li>• Initial reset display ended</li> </ul>



**Notice**

① The display --- signals only the completed initial reset process. Depending on the result, there may be an initial reset fault.

Following the sequence above, the initial reset must be carried out separately for each individually selected sensing tube.

## 7.3.6 Displaying the firmware version

On the ADW 535HDx the switch position **F** can be used to display the version of the firmware currently loaded.

Measure	Display	Procedure / remarks
(1)  Press key	Flashing <b>A1 &gt; L01 &gt; 115 &gt; L02 &gt; 115</b> (in sequence), or other	<ul style="list-style-type: none"> <li>Display of the <b>default</b> setting or the installation-specific switch setting</li> </ul>
(2)  Press the key several times until display <b>F</b>	In sequence <b>A1 / C / E / F</b>	<ul style="list-style-type: none"> <li>Displays the switch position group <b>F</b></li> </ul>
(3)  Press key	After approx. 2 s. in sequence e.g. <b>V01</b> . Pause <b>02</b> . Pause <b>xx</b>	<ul style="list-style-type: none"> <li>Displays the firmware version, in this case V01.02.xx</li> </ul>





## 7.3.7 Logging off additional modules XLM 35, RIM 36, SIM 35 and the SD memory card

The additional modules (XLM 35, RIM 36, SIM 35) and the SD memory card are automatically detected when the device is switched on; from that point onwards, they are monitored and fully functional. The SD memory card begins with data logging, recognisable on the flashing "Com" LED on the LMB. To eject the SD memory card or remove a subsequently fitted additional module (e.g. because it is not being used), the additional modules and SD memory card must first be logged off via the LMB 35 main board.



### Notice

A time-out (approx. 15 s) is configured for the logoff procedure. During this time the additional modules can be electrically disconnected from the LMB 35 trouble-free or the SD memory card can be removed from the holder. If no component is removed during this timeout (including removing the SD memory card), the additional modules are re-activated and data logging on the SD memory card continues.

Measure	Display	Procedure / remarks
(1)  Press key	Flashing <b>A1 &gt; L01 &gt; 115 &gt; L02 &gt; 115</b> (in sequence), or other	<ul style="list-style-type: none"> <li>Display of the <b>default</b> setting or the installation-specific switch setting</li> </ul>
(2)  Press the key several times until display on <b>o</b>	In sequence <b>A1 / C / E / F / I / N / o</b>	<ul style="list-style-type: none"> <li>Displays the switch position group <b>o</b></li> </ul>
(3)  Press key	<b>o00</b>	<ul style="list-style-type: none"> <li>Display log off of additional module / SD memory card</li> </ul>
(4)  Press the key again	Flashing <b>o - -</b> (timeout approx. 15 s)	<ul style="list-style-type: none"> <li>Start logoff procedure, duration approx. 15 s</li> </ul>
(5)	Electrically disconnect (ribbon cable) the relevant additional module within the logoff time (15 s) or remove the SD memory card.	<ul style="list-style-type: none"> <li>If the module is not electrically disconnected from the LMB 35 within 15 s (including removal of the SD memory card), it is re-activated and data logging on the SD memory card continues</li> </ul>

## 7.4 Re-programming



### Notice

The ADW parameters are configured ex works with default states and values so that the triggering properties comply with EN 54-22 / NFPA 72 / RVS / KFI. Changing the parameters may result in non-compliance with this standard/guideline. Any adjustments or modifications to the ADW 535HDx using the “ADW Config” configuration software or the user interface on the FACP may only be carried out by the manufacturer or by qualified personnel trained by the manufacturer.

### 7.4.1 Re-programming on the ADW 535HDx

If a different switch position has to be selected within the pre-set system limits (**C** > **A1** to **T3** and **W00** to **W09**), re-programming is performed as described in Sec. 7.3.3.

### 7.4.2 Re-programming with “ADW Config” configuration software

When changing parameters as described in Sec. 7.2.1 and 7.2.2, use the “ADW Config” configuration software.

### 7.4.3 Re-programming from SecuriFire / Integral with XLM 35

When connecting to the SecuriFire or Integral FACP via an XLM 35, control operations and changes can be made to the ADW device configuration directly from the FACP. For this purpose the FACP user software “SecuriFire Studio” and “[Integral Application Center](#)” are used to start the “ADW Config” configuration software for access to the ADWs; the configuration software is then used to make changes to the ADW 535HDx ([Config over Line](#)).

## 7.5 Upload new firmware to the ADW 535HDx



An FW upgrade can be performed in two ways:

- From SD memory card
- Via Ethernet port from the “ADW Config” configuration software.

### 7.5.1 FW upgrade from SD memory card

When upgrading the FW from the SD memory card, first the new FW must be saved to the SD memory card in the highest directory (not in a sub-directory).

The workflow for upgrading the FW from the SD memory card is described below (see also **Fig. 35**):

<b>Notices</b>		
 <ul style="list-style-type: none"> <li>• If an SD memory card is inserted on the LMB 35 for data logging, it must first be logged off using <i>EasyConfig</i> switch position <b>o</b> and removed as described in Sec. 7.3.7.</li> <li>• The internal program “<b>Bootloader</b>” is used for the FW upgrade. Activation of the <b>Bootloader</b> causes the fault relay to trigger. When upgrading the FW on the ADW 535HDx, it is therefore essential to switch off <b>fire incident controls and remote alerting</b> on superordinate systems (FACP) beforehand.</li> </ul>		
Measure	Display on LMB 35	Procedure / remarks
(1) If present, log off the SD memory card via switch position <b>o</b> and remove.		<ul style="list-style-type: none"> <li>• See Sec. 7.3.7</li> </ul>
(2) Copy the FW file to be transferred to the SD memory card and then re-insert the SD memory card in the ADW.		<ul style="list-style-type: none"> <li>• On the SD memory card to the <b>topmost</b> level (no sub-directory). <b>Important: only one</b> FW file may be saved.</li> </ul>
(3) While pressing and holding the “OK” key on the LMB 35, <b>briefly press</b> the “Reset” key. Release the “OK” key.	<b>bl</b> - (“ <b>Bootloader</b> ” display)	<ul style="list-style-type: none"> <li>• Displays “<b>Wdog</b>” continuously lit</li> <li>• LED “AL1” and “Flt1” (and “AL2” and “Flt2”) continuously lit</li> <li>• ADW triggers fault</li> </ul>
(4) Transmission to the ADW 535HDx begins (takes approx. 10 s) → see also ☉	<b>Sd</b> - (displays “from SD memory card”)	<ul style="list-style-type: none"> <li>• Transmission running</li> </ul>
(5) Firmware upgrade is completed	Flashing --- (approx. 4 x)	<ul style="list-style-type: none"> <li>• Fault is reset</li> <li>• ADW start phase running (LED “Fault” flashes about 60 s)</li> <li>• ADW continues running with the previous system-specific settings</li> <li>• <b>Firmware upgrade is completed</b></li> </ul>
<b>Notice</b>		
 <p>Afterwards, normal data logging begins automatically on the still inserted SD memory card. If this is not wanted, the SD memory card must be logged off and removed after the FW upgrade (via switch position <b>o</b>).</p>		
(6) After a waiting time of at least 5 min. from point (5) an initial reset must be performed again. <b>Attention:</b> only necessary if expressly mentioned in the relevant firmware description.	According to Sec. 7.3.5	<ul style="list-style-type: none"> <li>• Observe the firmware description for the loaded FW</li> <li>• According to Sec. 7.3.5</li> </ul>

- ① If at step (4) an immediate cancellation of the **Sd** - display occurs (reason: incompatible, third-party or no FW on the SD memory card), refer to the instructions of the concerned firmware description (**changes:** file designation of the FW; **compatibility:** required HW for this FW).

### 7.5.2 FW upgrade from PC via “ADW Config” configuration software

Here the FW upgrade is via the Ethernet interface of the LMB 35 using the “ADW Config” configuration software.

<b>Notice</b>		
 <p>The FW upgrade causes the fault relay to trigger. When upgrading the FW on the ADW 535HDx, it is therefore essential to switch off <b>fire incident controls and remote alerting</b> on superordinate systems (FACP) beforehand.</p>		
Measure	Display on LMB 35	Procedure / remarks
(1) In “ADW Config” select “ <b>Tools</b> ” > “ <b>Download firmware</b> ”		<ul style="list-style-type: none"> <li>The “<b>Download firmware</b>” window opens</li> </ul>
(2) Under “ <b>Firmware image</b> ” > “ <b>Select</b> ” find the directory containing the new FW. Select the file with the new firmware and click “ <b>Open</b> ”		<ul style="list-style-type: none"> <li>Selection of the new firmware</li> </ul>
(3) Under “ <b>Control</b> ” press “ <b>Download</b> ” → the steps (4) to (5) proceed automatically	<b>bL</b> - (“ <b>Bootloader</b> ” display)	<ul style="list-style-type: none"> <li>Display “<b>Wdog</b>” continuously lit</li> <li>LED “AL1” and “Flt1” (and “AL2” and “Flt2”) continuously lit</li> <li>ADW triggers fault</li> </ul>
(4) Transmission to the ADW 535HDx begins (takes approx. 10 s)	<b>PC</b> - (displays “from PC”)	<ul style="list-style-type: none"> <li>Transmission running → “<b>Download firmware</b>” window under “<b>Status</b>” shows the progress of the upgrade procedure</li> </ul>
(5) Firmware upgrade is completed	Flashing - - - (approx. 4 x)	<ul style="list-style-type: none"> <li>Fault is reset</li> <li>ADW continues running with the previous system-specific settings</li> <li><b>Firmware upgrade is completed</b></li> </ul>
(6) After a waiting time of at least 5 min. from point (5) an initial reset must be performed again. <b>Attention:</b> only necessary if expressly mentioned in the relevant firmware description.	According to Sec. 7.3.5	<ul style="list-style-type: none"> <li>Observe the firmware description for the loaded FW</li> <li>According to Sec. 7.3.5</li> </ul>

### 7.6 Measurements

















The ADW supply voltage on terminals 1 and 2 must be checked (check also terminals 3 and 4 in the case of a redundant supply). If the FACP voltage supply is correctly set (not emergency current operation), the voltage should range between 10.8 and 13.8 VDC (when operated in 12 VDC mode) or between 21.6 and 27.6 VDC (when operated in 24 VDC mode). The value depends on the line length. Once commissioning is completed, the measured voltage value is to be entered in the commissioning protocol (see Sec. 7.8).

With the conductor cross-section determined and installed as described in Sec. 4.8.2, this voltage range must always be available at the end of the electrical installation – i.e. at the ADW 535HDx – to ensure that the ADW 535HDx is able to operate fault-free (see also Sec. 4.8.2).

<b>Notices</b>	
 <ul style="list-style-type: none"> <li>If the measured value is outside the specified range, the ADW 535HDx may malfunction or even become damaged (over 30 VDC).</li> <li>Voltage values that are too low can be caused by insufficiently dimensioned conductor cross-sections or an incorrectly set FACP voltage.</li> </ul>	

## 7.6.1 Reading out the set configuration and pressure values

Besides the measurement of the voltage supply on the ADW 535HDx, the set configuration (selected switch position when commissioning **C** > **A1** to **T3** and **C** > **W00** to **W09** according to Sec. 4.5.1.1 or configured switch position **X01** to **X03**) and the pressure values "Test pressure", "Initial reset pressure" and "Absolute pressure" (**P** > **UP1** to **MP2**) must also be recorded and entered in the commissioning protocol (see also Sec. 7.8).

Measure	Display	Procedure / remarks
(1)  Poll response grade and sensing tube length Briefly press key	Flashing, e.g. <b>A2</b> > <b>L01</b> > <b>085</b> > <b>L02</b> > <b>095</b> (in sequence) or other	<ul style="list-style-type: none"> <li>Display of the commissioned switch positions <b>A1</b> to <b>T3</b>, <b>W00</b> to <b>W09</b>, <b>X01</b> to <b>X03</b> and sensing tube lengths (e.g. <b>L01</b> &gt; <b>085</b> = 85 m for sensing tube I)</li> </ul>
(2)  Sensing tube I initial reset pressure Press the key several times until display on <b>P</b>	In sequence <b>A2</b> / <b>C</b> / <b>E</b> / <b>F</b> / <b>I</b> / <b>N</b> / <b>o</b> / <b>P</b>	<ul style="list-style-type: none"> <li>Displays the switch position group <b>P</b></li> </ul>
(3)  Press key > <b>UP1</b>	<b>UP1</b>	<ul style="list-style-type: none"> <li>Selection of initial reset pressure for sensing tube I</li> </ul>
(4)  Press the key again	After approx. 2 s, in sequence e.g. <b>+ / 008 / .7 / - / 000 / .2</b>	<ul style="list-style-type: none"> <li>Displays initial reset pressure of sensing tube I, <b>nominal value</b></li> <li>= +8.7 mbar / -0.2 mbar (max. / min.)</li> </ul>
(5)  Sensing tube II initial reset pressure Press the key several times until display on <b>P</b>	In sequence <b>A2</b> / <b>C</b> / <b>E</b> / <b>F</b> / <b>I</b> / <b>N</b> / <b>o</b> / <b>P</b>	<ul style="list-style-type: none"> <li>Displays the switch position group <b>P</b></li> </ul>
(6)  Press key	<b>UP1</b>	<ul style="list-style-type: none"> <li>Selection of initial reset pressure for sensing tube I</li> </ul>
(7)  Press the key several times until display on > <b>UP2</b>	In sequence <b>UP1</b> / <b>UP2</b>	<ul style="list-style-type: none"> <li>Selection of initial reset pressure for sensing tube II</li> </ul>
(8)  Press key	After approx. 2 s, in sequence e.g. <b>+ / 007 / .4 / - / 000 / .4</b>	<ul style="list-style-type: none"> <li>Displays initial reset pressure of sensing tube II, <b>nominal value</b></li> <li>= +7.4 mbar / -0.4 mbar (max. / min.)</li> </ul>
(9)  Initial reset length sensing tube I Press the key several times until display on <b>P</b>	In sequence <b>A2</b> / <b>C</b> / <b>E</b> / <b>F</b> / <b>I</b> / <b>N</b> / <b>o</b> / <b>P</b>	<ul style="list-style-type: none"> <li>Displays the switch position group <b>P</b></li> </ul>
(10)  Press key	<b>UP1</b>	<ul style="list-style-type: none"> <li>Selection of initial reset pressure for sensing tube I</li> </ul>
(11)  Press the key several times until display on > <b>UL1</b>	In sequence <b>UP1</b> / <b>UP2</b> / <b>UL1</b>	<ul style="list-style-type: none"> <li>Selection of initial reset length for sensing tube I</li> </ul>
(12)  Press key	after approx. 2 s e.g. <b>085</b>	<ul style="list-style-type: none"> <li>Display initial reset length sensing tube I</li> <li>= 85 m (calculated from <b>UP1</b>)</li> </ul>
(13)  Initial reset length sensing tube II Press the key several times until display on <b>P</b>	In sequence <b>A2</b> / <b>C</b> / <b>E</b> / <b>F</b> / <b>I</b> / <b>N</b> / <b>o</b> / <b>P</b>	<ul style="list-style-type: none"> <li>Displays the switch position group <b>P</b></li> </ul>
(14)  Press key	<b>UP1</b>	<ul style="list-style-type: none"> <li>Selection of initial reset pressure for sensing tube I</li> </ul>
(15)  Press the key again until display on <b>UL2</b>	In sequence <b>UP1</b> / <b>UP2</b> / <b>UL1</b> / <b>UL2</b>	<ul style="list-style-type: none"> <li>Selection of initial reset length for sensing tube II</li> </ul>
(16)  Press key	after approx. 2 s e.g. <b>095</b>	<ul style="list-style-type: none"> <li>Display initial reset length sensing tube II</li> <li>= 95 m (calculated from <b>UP2</b>)</li> </ul>



















### Notice

① On an ADW 535-1HDx the steps (7) to (10), (15) to (18), (23) to (26) and (31) to (34) do not appear in the sequence.



Continuation:

(17)	 <b>Sensing tube I test pressure</b> Press the key several times until display on <b>P</b>	In sequence <b>A2 / C / E / F / I / N / o / P</b>	<ul style="list-style-type: none"> <li>Displays the switch position group <b>P</b></li> </ul>
(18)	 Press key	<b>UP1</b>	<ul style="list-style-type: none"> <li>Selection of initial reset pressure for sensing tube I</li> </ul>
(19)	 Press the key several times until display on > <b>TP1</b>	In sequence <b>UP1 / UP2 / UL1 / UL2 / TP1</b>	<ul style="list-style-type: none"> <li>Selection of test pressure for sensing tube I</li> </ul>
(20)	 Press key	After approx. 2 s, in sequence e.g. <b>- / 008 / .8 / + / 000 / .1</b> > ② ③	<ul style="list-style-type: none"> <li>Displays test pressure of sensing tube I, <b>actual value</b></li> <li>= -8.8 mbar / +0.1 mbar (max. / min.)</li> </ul>
(21)	①  <b>Sensing tube II test pressure</b> Press the key several times until display on <b>P</b>	In sequence <b>A2 / C / E / F / I / N / o / P</b>	<ul style="list-style-type: none"> <li>Displays the switch position group <b>P</b></li> </ul>
(22)	 Press key	<b>UP1</b>	<ul style="list-style-type: none"> <li>Selection of initial reset pressure for sensing tube I</li> </ul>
(23)	 Press the key again until display on <b>TP2</b>	In sequence <b>UP1 / UP2 / UL1 / UL2 / TP1 / TP2</b>	<ul style="list-style-type: none"> <li>Selection of test pressure for sensing tube II</li> </ul>
(24)	 Press key	After approx. 2 s, in sequence e.g. <b>- / 007 / .5 / + / 000 / .3</b> > ② ③	<ul style="list-style-type: none"> <li>Displays test pressure of sensing tube II, <b>actual value</b></li> <li>= -7.5 mbar / +0.3 mbar (max. / min.)</li> </ul>
(25)	 <b>Sensing tube I absolute pressure</b> Press the key several times until display on <b>P</b>	In sequence <b>A2 / C / E / F / I / N / o / P</b>	<ul style="list-style-type: none"> <li>Displays the switch position group <b>P</b></li> </ul>
(26)	 Press key	<b>UP1</b>	<ul style="list-style-type: none"> <li>Selection of initial reset pressure for sensing tube I</li> </ul>
(27)	 Press the key several times until display on > <b>MP1</b>	In sequence <b>UP1 / UP2 / UL1 / UL2 / TP1 / TP2 / MP1</b>	<ul style="list-style-type: none"> <li>Selection of absolute pressure measurement for sensing tube I</li> </ul>
(28)	 Press key	After approx. 2 s, in sequence e.g. <b>+ / 018 / .2</b>	<ul style="list-style-type: none"> <li>Displays absolute pressure sensing tube I</li> <li>= +18.2 mbar</li> </ul>
(29)	①  <b>Absolute pressure sensing tube II</b> Press the key several times until display on <b>P</b>	In sequence <b>A2 / C / E / F / I / N / o / P</b>	<ul style="list-style-type: none"> <li>Displays the switch position group <b>P</b></li> </ul>
(30)	 Press key	<b>UP1</b>	<ul style="list-style-type: none"> <li>Selection of initial reset pressure for sensing tube I</li> </ul>
(31)	 Press the key several times until display on > <b>MP2</b>	In sequence <b>UP1 / UP2 / UL1 / UL2 / TP1 / TP2 / MP2</b>	<ul style="list-style-type: none"> <li>Selection of absolute pressure measurement for sensing tube II</li> </ul>
(32)	 Press key	After approx. 2 s, in sequence e.g. <b>+ / 017 / .8</b>	<ul style="list-style-type: none"> <li>Displays absolute pressure sensing tube II</li> <li>= +17.8 mbar</li> </ul>











### Notices

- ① On an ADW 535-1HDx the steps (7) to (10), (15) to (18), (23) to (26) and (31) to (34) do not appear in the sequence.
- ② The display shows the result of the most recent test, called up from “**Monitoring and interruption detection**” and/or from “**Cyclical test**” (see Sec. 2.2.9) or by the manual test “**Manually test testing procedure sensing tube I / II**” as described in Sec. 7.7.1.
- ③ **Caution:** The +/- signs of the test pressure can be reversed compared to the initial reset. This depends on the initial situation of the pressure pump of the monitoring equipment prior to the test and thus whether overpressure or underpressure was generated. Important for the comparison to the initial reset pressure is the size of the value (example: initial reset pressure → **+8.7** compared to the test pressure → **-8.8**).

## Commissioning

### 7.6.2 Read out of the set IP configuration

The currently set IP configuration can be read out via the **N** switch position. Further, a factory setting of the IP configuration can be performed.

Measure	Display	Procedure / remarks
(1)  <b>Polling IP configuration</b> Press the key until display on <b>N</b>	in succession <b>A2 / C / E / F / I / N</b>	<ul style="list-style-type: none"><li>Displays switch position group <b>N</b></li></ul>
(2)  Press key > <b>RE</b>	<b>RE</b>	<ul style="list-style-type: none"><li>Displays <b>RE</b> polling mode</li></ul>
(3)  Press key	flashing after approx. 2 s: <b>IP / 169. / 254. / 001. / 001</b> <b>Sub / 255. / 255. / 000. / 000</b> <b>GA / 169. / 254. / 000. / 254</b>	Display of the factory setting: <ul style="list-style-type: none"><li>Displays the IP address</li><li>Displays the IP subnet mask</li><li>Displays the default gateway</li></ul>
(4)  <b>Factory setting</b> Press the key until display on <b>N</b>	in succession <b>A2 / C / E / F / I / N</b>	<ul style="list-style-type: none"><li>Displays switch position group <b>N</b></li></ul>
(5)  Press key > <b>RE</b>	<b>RE</b>	<ul style="list-style-type: none"><li>Displays <b>RE</b> polling mode</li></ul>
(6)  Press key > <b>SE</b>	<b>SE</b>	<ul style="list-style-type: none"><li>Displays <b>SE</b> input mode</li></ul>
(7)  Press key > <b>FSE</b>	<b>FSE</b>	<ul style="list-style-type: none"><li>Displays <b>FSE (FactorySEttings)</b></li></ul>
(8)  Press key 3 x	flashing - - - (approx. 4 x)	<ul style="list-style-type: none"><li>The IP configuration was reset to the factory setting (see (3))</li></ul>

### 7.7 Testing and checking

In addition to the checks described in Sec. 7.1, the correct triggering of alarms (zone and line) to the FACP when faults or alarms are triggered on the ADW 535HDx have to be tested. These tests are to be entered in the commissioning protocol (see also Sec. 7.8).

For every ADW 535HDx it is necessary to perform fine adjustments to the operating conditions. For tunnels it is therefore recommended to run the entire venting program after the first setting so that venting-related temperature fluctuations cannot lead to alarm releases.

Testing the effective "heat" characteristic is usually not necessary. See also the notice below:



#### Use in potentially explosive atmospheres

##### Testing with heat EXPLOSION HAZARD!

Testing the response characteristics of the ADW 535HDx by means of effective fire characteristic "heat" (hot air blower) is not possible due to the potentially explosive atmosphere (see also Sec. 7.7.2).

If required, it is possible to generate the necessary heat (similar to an actual fire) with hot water or steam to simulate the response of the ADW 535HDx (test coil, see also Sec. 5.4.2.4).

## 7.7.1 Test triggerings



## Notices about test triggerings

**Fire incident control** and remote alerting must be blocked or deactivated on the superordinate FACP.

The function “**Test pre-signal**” can also be triggered in non parameterized pre-signal (e.g. in positions **A1** to **T3**).

















- ① Between each check, reset the ADW 535HDx (preferably on the FACP since a reset on the ADW does not reset the FACP).
- ② On the ADW 535-2HDx the checks for both sensing tubes have to be carried out (on ADW 535-1HDx the steps (5) to (8), (13) to (16), (21) to (24) and (29) to (32) do not appear in the workflow).

Measure	Display	Procedure / remarks
(1)  Press key	Flashing, e.g. <b>A2 &gt; L01 &gt; 085</b> > <b>L02 &gt; 095</b> (in sequence) or other	• Display of the commissioned switch positions <b>A1</b> to <b>T3</b> , <b>W00</b> to <b>W09</b> , <b>X01</b> to <b>X03</b> and sensing tube lengths (e.g. <b>L01 &gt; 085</b> = 85 m for sensing tube I)
(2) <b>Sensing tube I test alarm</b> Press the key several times until display on <b>I</b>	In sequence <b>A2 / C / E / F / I</b>	• Displays switch position group <b>I</b>
(3)  Press key > <b>IA1</b>	<b>IA1</b> (possible selection here: <b>IA1 / IA2 / IF1 / IF2 / IP1 / IP2 / IC1 / IC2</b> )	• Displays test mode “Test alarm from <i>EasyConfig</i> ” for <b>sensing tube I</b>
(4)  Press key <b>3 x</b>	Flashing <b>IA1</b> (until reset)	• ADW 535HDx triggers Alarm I → via relay or XLM to FACP → reset from FACP ①
(5) ② <b>Sensing tube II test alarm</b> Press the key several times until display on <b>I</b>	In sequence <b>A2 / C / E / F / I</b>	• Displays switch position group <b>I</b>
(6)  Press key	<b>IA1</b>	• Displays test mode “Test alarm from <i>EasyConfig</i> ” for <b>sensing tube I</b>
(7)  Press key until display on <b>IA2</b>	In sequence <b>IA1 / IA2</b>	• Displays test mode “Test alarm from <i>EasyConfig</i> ” for <b>sensing tube II</b>
(8)  Press key <b>3 x</b>	Flashing <b>IA2</b> (until reset)	• ADW 535HDx triggers Alarm II → via relay or XLM to FACP → reset from FACP ①
(9) <b>Sensing tube I test fault</b> Press the key several times until display on <b>I</b>	In sequence <b>A2 / C / E / F / I</b>	• Displays switch position group <b>I</b>
(10)  Press key	<b>IA1</b>	• Displays test mode “Test alarm from <i>EasyConfig</i> ” for <b>sensing tube I</b>
(11)  Press the key several times until display on <b>IF1</b>	In sequence <b>IA1 / IA2 / IF1</b>	• Displays test mode “Test fault from <i>EasyConfig</i> ” for <b>sensing tube I</b>
(12)  Press key <b>3 x</b>	Flashing <b>IF1</b> (until reset)	• ADW 535HDx triggers Fault I → via relay or XLM to FACP → reset from FACP ①
(13) ② <b>Sensing tube II test fault</b> Press the key several times until display on <b>I</b>	In sequence <b>A2 / C / E / F / I</b>	• Displays switch position group <b>I</b>
(14)  Press key	<b>IA1</b>	• Displays test mode “Test alarm from <i>EasyConfig</i> ” for <b>sensing tube I</b>
(15)  Press the key several times until display on <b>IF2</b>	In sequence <b>IA1 / IA2 / IF1 / IF2</b>	• Displays test mode “Test fault from <i>EasyConfig</i> ” for <b>sensing tube II</b>
(16)  Press key <b>3 x</b>	Flashing <b>IF2</b> (until reset)	• ADW 535HDx triggers Fault II → via relay or XLM to FACP → reset from FACP ①



## Commissioning

Continuation:

(17)	 <b>Sensing tube I test pre-signal</b> Press the key several times until display on <b>I</b>	In sequence <b>A2 / C / E / F / I</b>	<ul style="list-style-type: none"> <li>Displays switch position group <b>I</b></li> </ul>
(18)	 Press key	<b>IA1</b>	<ul style="list-style-type: none"> <li>Displays test mode "Test alarm from <i>EasyConfig</i>" for <b>sensing tube I</b></li> </ul>
(19)	 Press the key several times until display on <b>IP1</b>	In sequence <b>IA1 / IA2 / IF1 / IF2 / IP1</b>	<ul style="list-style-type: none"> <li>Displays test mode "Test pre-signal from <i>EasyConfig</i>" for <b>sensing tube I</b></li> </ul>
(20)	 Press key <b>3 x</b>	Flashing <b>IP1</b> (until reset)	<ul style="list-style-type: none"> <li>ADW 535HDx triggers Pre-signal I → via relay or XLM to FACP → reset from FACP ①</li> </ul>
(21)	 <b>Sensing tube II test pre-signal</b> Press the key several times until display on <b>I</b>	In sequence <b>A2 / C / E / F / I</b>	<ul style="list-style-type: none"> <li>Displays switch position group <b>I</b></li> </ul>
(22)	 Press key	<b>IA1</b>	<ul style="list-style-type: none"> <li>Displays test mode "Test alarm from <i>EasyConfig</i>" for <b>sensing tube I</b></li> </ul>
(23)	 Press the key several times until display on <b>IP2</b>	In sequence <b>IA1 / IA2 / IF1 / IF2 / IP1 / IP2</b>	<ul style="list-style-type: none"> <li>Displays test mode "Test pre-signal from <i>EasyConfig</i>" for <b>sensing tube II</b></li> </ul>
(24)	 Press key <b>3 x</b>	Flashing <b>IP2</b> (until reset)	<ul style="list-style-type: none"> <li>ADW 535HDx triggers Pre-signal II → via relay or XLM to FACP → reset from FACP ①</li> </ul>
(25)	 <b>Manually test sensing tube I test procedure</b> Press the key several times until display on <b>I</b>	In sequence <b>A2 / C / E / F / I</b>	<ul style="list-style-type: none"> <li>Displays switch position group <b>I</b></li> </ul>
(26)	 Press key	<b>IA1</b>	<ul style="list-style-type: none"> <li>Displays test mode "Test alarm from <i>EasyConfig</i>" for <b>sensing tube I</b></li> </ul>
(27)	 Press the key several times until display on <b>IC1</b>	In sequence <b>IA1 / IA2 / IF1 / IF2 / IP1 / IP2 / IC1</b>	<ul style="list-style-type: none"> <li>Test mode indication "Test testing from <i>EasyConfig</i>" for <b>sensing tube I</b></li> </ul>
(28)	 Press key <b>3 x</b>	Flashing <b>IC1</b> (as long as step motor is running) → afterwards flashing - - -	<ul style="list-style-type: none"> <li>ADW 535HDx starts test on <b>sensing tube I</b> → if negative results (comparison to nominal value from initial reset) fault I is triggered → reset from FACP ①</li> </ul>
(29)	 <b>Test sensing tube II</b> Press the key several times until display on <b>I</b>	In sequence <b>A2 / C / E / F / I</b>	<ul style="list-style-type: none"> <li>Displays switch position group <b>I</b></li> </ul>
(30)	 Press key	<b>IA1</b>	<ul style="list-style-type: none"> <li>Displays test mode "Test alarm from <i>EasyConfig</i>" for <b>sensing tube I</b></li> </ul>
(31)	 Press the key several times until display on <b>IC2</b>	In sequence <b>IA1 / IA2 / IF1 / IF2 / IP1 / IP2 / IC1 / IC2</b>	<ul style="list-style-type: none"> <li>Displays test mode "Test testing from <i>EasyConfig</i>" for <b>sensing tube II</b></li> </ul>
(32)	 Press key <b>3 x</b>	Flashing <b>IC2</b> (as long as step motor is running) → afterwards flashing - - -	<ul style="list-style-type: none"> <li>ADW 535HDx starts test on <b>sensing tube II</b> → if negative results (comparison to nominal value from initial reset) fault II is triggered → reset from FACP ①</li> </ul>

### 7.7.2 Checking the alarm release



#### Use in potentially explosive atmospheres

##### Testing with heat EXPLOSION HAZARD!

Testing the response characteristics of the ADW 535HDx by means of effective fire characteristic "heat" (hot air blower) is not possible due to the potentially explosive atmosphere!

If required, it is possible to generate the necessary heat (similar to an actual fire) with hot water or steam to simulate the response of the ADW 535HDx (test coil, see also Sec. 5.4.2.4).

Owing to the automatic pneumatic testing of the sensing tube, a check of the effective "heat" fire characteristic is generally not necessary. If required, however, it is possible to generate the necessary heat (similar to an actual fire) with test devices to simulate the response of the ADW 535HDx.

The alarm release by heat can be actuated via the sensing tube as follows:

- **Point by point testing of the sensing tube:** point by point testing of the sensing tube can be performed only with a test coil in the sensing tube (see Sec. 5.4.2.1 and 5.4.2.4). An alarm can be triggered by subjecting the test coil to a stream of hot water or steam (hot air blower only outside potentially explosive atmospheres!) for about 60 s.
- **Area-wide testing of the sensing tube → only outside potentially explosive atmospheres:** Area-wide testing of the sensing tube using fire tests is reasonable and practicable only following the relevant standard/guideline (EN 54-22 / NFPA 72 / RVS / KFI).



#### Notice

If genuine fire tests are to be carried out, the relevant local authorities (fire service) are to be consulted beforehand; the tests themselves are to be carried out by trained specialists (manufacturer) only.

### 7.8 Commissioning protocol

The ADW 535HDx ships with a commissioning protocol (fold-out) included in the scope of delivery. All of the measurements and tests carried out during commissioning and maintenance are to be entered on the protocol, which is then signed.



#### Notices

- When performing maintenance work or after certain other events, conclusions can be drawn concerning the commissioning state of the ADW 535HDx based on the commissioning protocol. The protocol also serves as a kind of life history of the ADW 535HDx.
- The commissioning protocol is to be filled out conscientiously and fully and stored in the ADW 535HDx. If required, a copy can be made and stored in the system dossier.

## 8 Operation

### 8.1 Operation and display elements

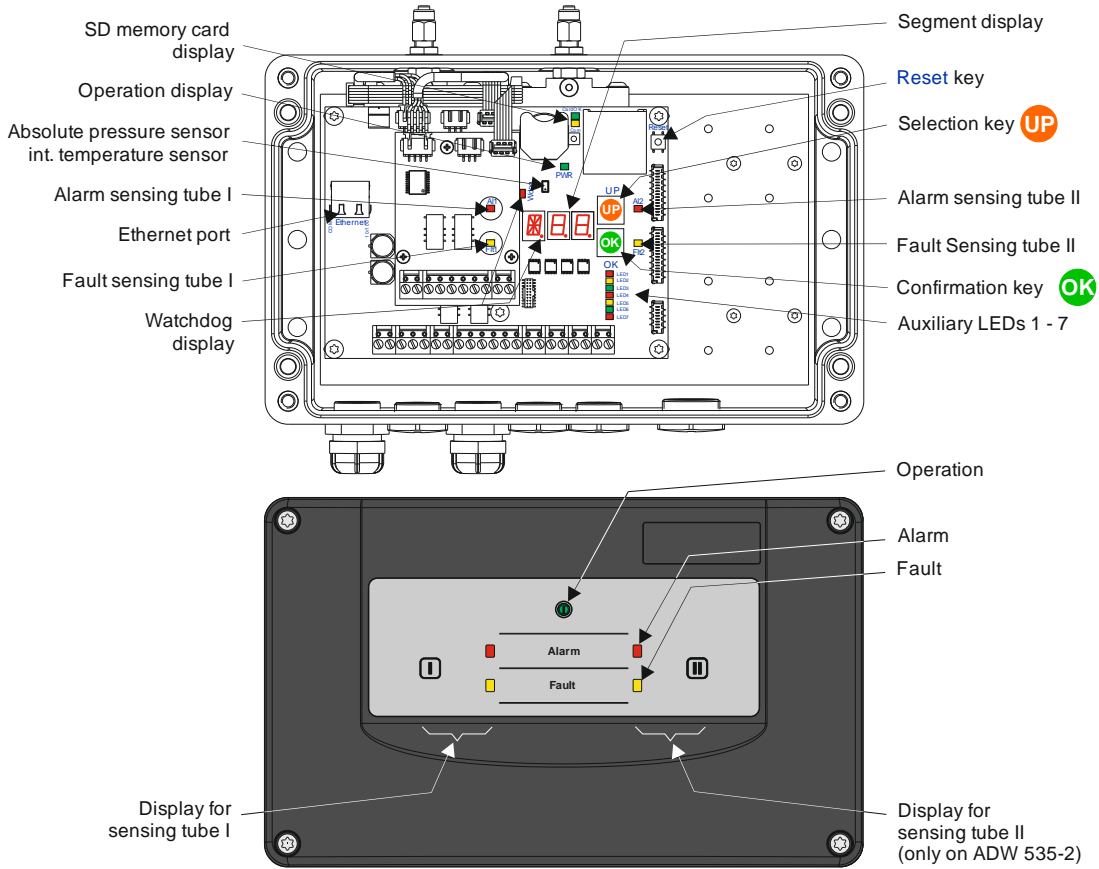

**Fig. 35 View of the operation and display elements**

All operation functions take place inside the device on the LMB 35 main board. It includes an alphanumeric display and two 7-segment displays as well as two buttons ("UP" / "OK").

## 8.2 Functional sequence of operation

The operation of the ADW 535HDx line type heat detector in normal operation (after commissioning) is limited to switching On/Off and resetting a triggered event (alarm, fault). Operation is generally via the FACP, with input of the “Zone On/Off” and “Reset” functions (on “Reset external” input of the ADW 535HDx).

With the **EasyConfig** switch position **R** (**R00** = state reset) on the LMB 35 or by briefly actuating the “Reset external”, the triggered events can be reset on the ADW 535HDx on site. The reset is possible only if the triggered event is no longer pending (e.g. pressure in the sensing tube undershoots the triggering value or the fault event is rectified). The application of a continuous signal at the “Reset external” input also deactivates (switches off) the ADW 535HDx (see also Sec. 2.2.5 and 6.5.2).



### Notice

A local reset does not reset a higher-order FACP. It may also happen that the reset in the ADW 535HDx triggers a fault in the superordinate line of the FACP.

To aid commissioning the ADW 535HDx, there are two 7-segment displays, an alphanumeric display, and two buttons (“UP” and “OK”) inside the device on the LMB 35 main board. These elements provide a type of rotary switch function, i.e. displays and positions in the range **A00** to **Z99** may appear.

These elements are used when commissioning the ADW 535HDx. Device settings for predefined system limits can also be called up – **EasyConFig**. These pre-defined positions are stored with normative values for response sensitivity and various sensing tube lengths. The **EasyConfig** process allows the device to be commissioned without the “ADW Config” software. If system-specific programming has to be carried out (e.g. after a calculation with “ADW HeatCalc” or when programming RIM 36), the “ADW Config” configuration software must be used.

## 8.3 Switch positions

The switch positions which can be called up via the segment display and the “UP” / “OK” buttons on the LMB 35 are listed below. The switch positions can be used for inputs (**C / I / o / R / S / T / U / W / X**) or for polling (**E / F / N / P / T**).

Stored under the rotary switch procedure is a **time-out** (approx. 5 s). If within this time period a process is not continued or completed, it is interrupted and the segment display automatically returns to the normal state (flashing point).

Pos.	Submenu / Area / Display	Purpose	Meaning / Procedure ②
<b>C</b>	<b>A1 to T3</b> ↳ <b>L01 / L02</b> ↳ <b>015 to 115</b> (or <b>200</b> ), (per tube)  <b>W00 to W09</b>	<b>Normative system limits</b> ① Compliant with EN 54-22, NFPA 72, RVS, KFI ↳ Sensing tube length tube I ( <b>L01</b> ), tube II ( <b>L02</b> ) ↳ Sensing tube length in 5 m increments, <b>015 to 115</b> (or <b>200</b> for NFPA 72 / RVS) <b>Sensing tube monitoring</b>	see Sec. 4.5.1.1, 4.5.1.2 and Sec. 7.3.3
<b>E</b>	<b>E01 to E99</b> ↳ <b>G00 to G99</b>	<b>Event memory</b> ; 99 events ( <b>E01</b> = last event) ↳ Event group <b>G00 to G99</b>	see Sec. 8.5.4
<b>F</b>	<b>V00. to 99</b> (3 blocks)	Read out <b>firmware version</b>	see Sec. 7.3.6
<b>I</b>	<b>IA1 / IA2</b> <b>IF1 / IF2</b> <b>IP1 / IP2</b> <b>IC1 / IC2</b>	<b>Trigger (Initiate)</b> ; Test alarm ( <b>IA.</b> ), up to the FACP Test fault ( <b>IF.</b> ), up to the FACP Test pre-signal ( <b>IP.</b> ), up to the FACP Manual test testing ( <b>IC.</b> ); Sensing tube I ( <b>..1</b> ), sensing tube II ( <b>..2</b> )	see Sec. 7.7.1
<b>N</b>	Polling ( <b>Read = RE</b> ) <b>IP / Sub / GA</b> ↳ <b>169. / 254. / 001. / 001</b> (default) Setting ( <b>Set = SE</b> ) ↳ <b>FSE</b>	<b>Polling IP configuration (Network)</b> ; IP address ( <b>IP</b> ), <b>Subnet (Sub)</b> , <b>Gateway (GA)</b>  <b>IP configuration factory setting</b> ; <b>FSE = FactorySettings</b>	see Sec. 7.6.2
<b>o</b>	<b>o00</b>	<b>Log off additional modules</b> ; (optional modules, all at same time)	see Sec. 7.3.7
<b>P</b>	<b>UP1 / UP2</b> <b>UL1 / UL2</b> <b>TP1 / TP2</b> <b>MP1 / MP2</b>	<b>Output pressure vales</b> (in mBar); “Initial reset pressure” = nominal value ( <b>UP.</b> ) “Initial reset sensing tube” ( <b>UL.</b> ), calculated from <b>UP</b> “Test pressure” = actual value ( <b>TP.</b> ) “Absolute pressure” ( <b>MP.</b> ) Sensing tube I ( <b>..1</b> ), sensing tube II ( <b>..2</b> )	see Sec. 7.6.1
<b>R</b>	<b>R00</b>	Perform <b>state reset</b>	
<b>S</b>	<b>Ch1 / Ch2</b> ↳ <b>on / oFF</b>	<b>Sensor activation</b> ; sensing tube I ( <b>Ch1</b> ), sensing tube II ( <b>Ch2</b> ) Activated ( <b>on</b> ), deactivated ( <b>oFF</b> )	Single, both possible, “ <b>Fault</b> ” display flashes ½ s cycle
<b>T</b>	<b>Y10 to Y99 / M01 to M12</b> <b>d01 to d31 / H00 to H23</b> <b>M00 to M59 / S00 to S59</b>	<b>Date and time</b> ; Polling ( <b>Read = RE</b> ), setting ( <b>Set = SE</b> )	see Sec. 7.3.4
<b>U</b>	<b>U01 / U02</b>	Start <b>initial reset</b> ; Sensing tube I ( <b>U01</b> ), sensing tube II ( <b>U02</b> )	see Sec. 7.3.5
<b>X</b>	<b>X01 to X03</b>	<b>Configurable switch positions</b>	see Sec. 7.2.1



### Notices

- ① For response-class-related use of the ADW 535HDx, the specifications in Sec. 4.1.1 must be observed.
- ② The table lists only the available switch positions. A detailed description of the operator functions (input procedure) can be found in the relevant section (“Meaning / Procedure” column).

## 8.4 Resetting

Resetting the ADW 535HDx after a triggered event can be accomplished:

- via the **EasyConfig** switch positions **R (R00)** on the ADW locally or
- by briefly actuating the input “Reset external” on the ADW.



### Notices

- Resetting can be triggered only after an event, but only if the criterion that resulted in the event trigger is again in its normal state (e.g. Diff pressure is again below the alarm threshold, or a fault event is rectified).
- Local resetting (“Reset” key) does not reset a superordinate FACP. It may also happen that the reset in the ADW 535HDx triggers a fault in the superordinate line of the FACP.

## 8.5 Displays

### 8.5.1 Displays on the housing surface

Several LEDs on the housing surface indicate the current state of the ADW 535HDx. The table below lists the states only for the ADW 535-1HDx (one sensing tube). For the ADW 535-2HDx the indicators are doubled (**I** and **II**, see **Fig. 35**), except the operation indicator.

Operation	Display Alarm	Fault	Function / state
Green	Red	Yellow	
			System off (no voltage)
On		½ s T	System inactive (Reset external) / Sensing tube deactivated
On			Quiescent state
On		1 s T	Start phase of the system (approx. 60 s)
On		1 s T	Sensing tube fault, test running ① / ②
On		On	Sensing tube fault, fault triggered
On		On	General fault triggered (internal faults)
On	1 s T		Pre-signal (Diff or Max)
On	On		Alarm (Diff or Max)



### Notices

- ① No fault triggered (triggers only after completion of the test procedure and if negative result → LED “Fault” continuously lit display).
  - ② The “flashing” indicator does not apply for testing with the “cyclical test procedure” and test triggering **IC1** / **IC2**.
- T = flashing display; ½ s cycle / 1 s cycle

### 8.5.2 Displays on the LMB 35 main board

Besides the segment display, the LMB 35 main board has various auxiliary LEDs with the following meanings (see also Fig. 35):

- Flashing point on the left-hand segment display = watchdog display (processor is running)
- On the segment display, flashing point on the left, point steady lit on the right = day/night control active (in **X01** – **X03** only)
- LED **CardOk** = SD memory card inserted
- LED **Com** = communication OK / SD memory card is logging
- LED **Wdog** = watchdog display (processor not running)
- LED 1 – 7 = Status displays (see Sec. 8.5.3.2).

Other output and display possibilities on the segment display include:

- in switch position **E** = event memory, see Sec. 8.5.4;
- in switch position **F** = firmware version, see Sec. 7.3.6;
- In switch position **N** = IP address, see Sec. 7.6.1
- In switch position **P** = pressure values, see Sec. 7.6.1
- In switch position **T** > **RE** = date, time, see Sec. 7.3.4
- “UP” key pressed = set configuration (**A1** to **X03**) and sensing tube lengths, see Sec. 7.6.1
- Flashing **000** = **Busy** message, a test/adjustment is in progress or possibly falsified → wait and repeat the entry
- Static **U** or flashing **01**, **02** = initial reset, vent sensing tube, see Sec. 7.3.5
- Flashing **U01**, **U02** = initial reset is running, see Sec. 7.3.5
- Flashing **IA1**, **IA2**, **IF1**, **IF2**, **IP1**, **IP2**, **IC1**, **IC2** = test trigger is activated, see Sec. 7.7.1.

### 8.5.3 SD memory card operation

The SD memory card is automatically detected when the device is switched on and when the card is inserted. From then on it is monitored. Data logging begins automatically after approx. 10 s.



#### Notices

- Only **industrial SD memory cards** tested and approved by the manufacturer may be used (see Sec. 12.1). The use of a Consumer SD memory card is to be avoided – this can lead to data loss or destruction of the SD memory card and faults on the ADW.
- Inserting the SD memory card: Before using the SD memory card, make sure it is blank (file interpretation).
- Removing the SD memory card: To avoid data loss, the SD memory card must be logged off on the LMB 35 (*EasyConfig* switch position o) before removing (see Sec. 7.3.7).

The SD memory card is inserted with the contact side facing toward the LMB circuit board and pushed into the holder until it snaps into place. Pressing the SD memory card again releases the locking mechanism and the SD memory card can then be removed from the holder.

The meaning of the LEDs **CardOk** and **Com** is described Sec. 8.5.2.

#### 8.5.3.1 Data logging on the SD memory card

**Pressure and temperature values:** The pressure and temperature values as well as the current status for each sensing tube are written to the SD memory card every second (default, can be changed with “ADW Config”) for each sensing tube and saved in **Log-files** (\*.xls file). After 28,800 entries (corresponding to 8 hours with an SD memory card interval of 1 s) a new **Log-File** is automatically generated. A total of 200 **log files** (L000.xls to L199.xls) can be generated for long-term logging. After the last **log file** the oldest one (L000.xls) is overwritten. The 200 **log files** are sufficient to cover 66 days of data logging (with SD memory card interval of 1 s). The **log files** can be opened in Excel and the data processed with the diagram assistant to create charts.

**Events:** All events that occur in the ADW 535HDx are written to the **Event-Files** (\*.lev file). After 64,000 events a new **Event-File** is created automatically. A total of 10 **Event-Files** (E000.lev to E009.lev) can be generated for long-term logging. After the last **Event-File** the oldest one (E000.lev) is overwritten. The 10 **Event-Files** are sufficient to log over 64,000 events. The **Event-Files** can be opened with a text editor. Please refer to Sec. 8.5.4 for the interpretation of the events. There is also the possibility of importing **Event-Files** using the “ADW Config” configuration software and displaying them as real event text.

## Operation

### 8.5.3.2 Meaning of the status abbreviations on the SD memory card and LEDs 1 – 7 on the LMB 35

The respective status of the ADW 535HDx can be viewed in the files on the SD memory card. It is shown for each sensing tube in the "Status I" and "Status II" columns with one of the following abbreviations:

Abbreviations SD memory card	LED 1 to LED 7 LMB 35 ①	Function / State
ADJ	LED 3	Adjust, temperature compensation
ALD		Triggering "Diff alarm"
ALM		Triggering "Max alarm"
AVT	LED 2	Alarm verification time running
BRA	LED 4	Break Assumption
DNR	LED 1	Diff Not Ready
ELA		Extended Leakage Analysis
IRS		Initial Reset
ISO		Sensing tube isolated
LST		Leaking Sensing Tube
MNR		Max Not Ready
POD		Pressure Offset Delay
POO		Pressure Offset Off
POR		Pressure Offset Regulation
SVO	LED 7	Sensing tube monitoring Off (Supervision Off)
TNR		Tube Not Ready
TOF	LED 6	Tube Off
TSD	LED 5	Test Delay
TST		Test



#### Notice

- ① The LEDs are lit differently based on the assignment of the sensing tube:
- ⇒ Flashing in 1 s cycle                      sensing tube I
  - ⇒ Flashing in ½ s cycle                      sensing tube II
  - ⇒ Continuous light                              sensing tube I + II





### 8.5.4 Displaying and reading out the event memory

The event memory can be called up via switch position **E**. The last 99 events (event positions **E01** to **E99**) of the overall 1,000 possible events can be accessed in it. Event position **E01** always contains the last (most recent) event. The event memory as a whole can be deleted only by the manufacturer.

Events are subdivided into groups (**G00** to **G99**) so they can be displayed using the 3 digits of the segment display. For each event group, up to 8 events can be displayed as a 3-digit code. The codes are added together and displayed if there are multiple pending events per event group.

8.5.4.1 Procedure and interpretation of the event memory display

The sequence below provides an example to illustrate how the next to last event, i.e. the second most recent event, is read out (**E02**). The result shows that the sensing tube I Diff alarm triggered.

Measure	Display	Procedure / remarks
(1)  Briefly press key	Flashing, e.g. <b>A2 &gt; L01 &gt; 085 &gt; L02 &gt; 095</b> or other	<ul style="list-style-type: none"> <li>Display of the commissioned switch positions <b>A1</b> to <b>T3</b>, <b>W00</b> to <b>W09</b>, <b>X01</b> to <b>X03</b> and sensing tube lengths (e.g. <b>L01 &gt; 085</b> = 85 m for sensing tube I)</li> </ul>
(2)  Press the key again until display on <b>E</b>	In sequence <b>A2 / C / E</b>	<ul style="list-style-type: none"> <li>Displays the switch position group <b>E</b></li> </ul>
(3)  Press key	<b>E01</b>	<ul style="list-style-type: none"> <li>Select event position <b>E01</b> (last event)</li> </ul>
(4)  Press key	<b>E02</b> ①	<ul style="list-style-type: none"> <li>Select event position <b>E02</b> (next to the last event)</li> </ul>
(5)  Press key	After about 2 s e.g. <b>G10</b>	<ul style="list-style-type: none"> <li>Displays the event group <b>G10</b>, sensing tube I events</li> </ul>
(6) Wait	After about 2 s e.g. <b>001</b> ②	<ul style="list-style-type: none"> <li>Display of event code <b>001</b>, Diff alarm sensing tube I</li> </ul>

**Notices**

 ① Pressing the “UP” key several times accesses all 99 event positions one after the other (**E01** to **E99**), i.e. displays them without content. If there are **empty event positions**, event group **G00** and code **000** are then output.

② **Multiple codes:** If the pre-signal preceded the alarm release of sensing tube I, the code **003** is displayed as a result at point (6). It is composed (i.e. added) of the individual codes **001** (Diff alarm) and **002** (pre-signal Diff alarm).

Please refer to Sec. 8.5.4.2 and 8.5.4.3 for a list of all the event groups and their events (codes).

## Operation

### 8.5.4.2 Event groups

Event group	Purpose
<b>G00</b>	General events, part 1 (ADW On/Off, inactive, sensing tube On/Off from FACP)
<b>G01</b>	General events, part 2 (time, start initial reset, event memory clearing)
<b>G02</b>	General events, part 3 (sensing tube On/Off via "ADW Config")
<b>G03</b>	General events, part 4 (reset events)
<b>G04</b>	General events, part 5 (temperature sensor LMB)
<b>G05</b>	General events, part 6 (temperature sensor LMB isolated)
<b>G06</b>	General events, part 7 (response grades configuration change)
<b>G07</b>	General events, part 8 (sensing tube monitoring configuration change)
<b>G08</b>	General events, part 9 (sensing tube On/Off via <b>EasyConfig</b> )
<b>G10</b>	Sensing tube I, events (Diff alarm, Max alarm, pre-signals, alarm verification)
<b>G11</b>	Ext. Temperature sensor I events (alarm, fault)
<b>G12</b>	Sensing tube I faults (pressure sensor events, step motor)
<b>G13</b>	Sensing tube I, isolated, part 1 (sensing tube isolated alarms)
<b>G14</b>	Sensing tube I, isolated, part 2 (isolated alarms temperature sensor)
<b>G15</b>	Sensing tube I, isolate, part 3 (On/Off)
<b>G16</b>	Sensing tube I, test triggerings from <b>EasyConfig</b> to FACP
<b>G17</b>	Sensing tube I, test events (test, adjustment, pressure offset)
<b>G18</b>	Sensing tube I, test triggerings from "ADW Config" to FACP
<b>G20</b>	Sensing tube II, events (Diff alarm, Max alarm, pre-signals, alarm verification)
<b>G21</b>	Ext. Temperature sensor II events (alarm, fault)
<b>G22</b>	Sensing tube II faults (pressure sensor events, step motor)
<b>G23</b>	Sensing tube II, isolated, part 1 (sensing tube isolated alarms)
<b>G24</b>	Sensing tube II, isolated, part 2 (isolated alarms temperature sensor)
<b>G25</b>	Sensing tube II, isolate, part 3 (On/Off)
<b>G26</b>	Sensing tube II, test triggerings from <b>EasyConfig</b> to FACP
<b>G27</b>	Sensing tube II, test events (test, adjustment, pressure offset)
<b>G28</b>	Sensing tube II, test triggerings from "ADW Config" to FACP
<b>G30</b>	Sensing tube I, faults (test interruption, crushing, leak, step motor, sensing tube length)
<b>G40</b>	Sensing tube II, faults (test interruption, crushing, leak, step motor, sensing tube length)
<b>G50</b>	Initial reset faults sensing tube I (invalid parameter, <b>Timeout</b> , sealing check / length check negative)
<b>G60</b>	Initial reset faults sensing tube II (invalid parameter, <b>Timeout</b> , sealing check / length check negative)
<b>G70</b>	RIM 1, RIM 2 faults
<b>G71</b>	XLM faults
<b>G72</b>	SD memory card / SIM faults
<b>G80</b>	LMB faults (operating system, undervoltage, clock, day/night control, type)

### 8.5.4.3 Event codes within event groups

<b>G00, general events, part 1, ADW On/Off, inactive, sensing tube On/Off from FACP</b>	
001	Switch on ADW (supply voltage)
002	ADW switched off (inactive, via "Reset external")
004	ADW switched on (via "Reset external")
008	Sensing tube I switched off from FACP (SecuriFire – Integral)
016	Sensing tube II switched off from FACP (SecuriFire – Integral)
032	Sensing tube I switched on from FACP (SecuriFire – Integral)
064	Sensing tube II switched on from FACP (SecuriFire – Integral)
<b>G01, general events, part 2, time, start initial reset, event memory clearing</b>	
001	Date, time set
002	Initial reset sensing tube I performed (ADW)
004	Initial reset sensing tube II performed (ADW)
008	Event memory deleted
016	Initial reset sensing tube I performed with "ADW Config"
032	Initial reset sensing tube II performed with "ADW Config"
<b>G02, general events, part 3, sensing tube On/Off via "ADW Config"</b>	
001	Sensing tube I deactivated via "ADW Config"
002	Sensing tube II deactivated via "ADW Config"
004	Sensing tube I activated via "ADW Config"
008	Sensing tube II activated via "ADW Config"
016	Sensing tube II switched on (partial planning)
032	Sensing tube II switched off (partial planning)



Continuation:

<b>G03, general events, part 4, reset events</b>													
001		Key											
002		SecuriLine											
004		"ADW Config" PC program											
008		External											
<b>G04, general events, part 5, temperature sensor LMB</b>													
004		Alarm LMB temperature sensor											
016		Fault temperature sensor LMB											
032		Invalid parameters, LMB temperature sensor											
<b>G05, general events, part 6, temperature sensor LMB isolated</b>													
004		Test alarm temperature sensor LMB											
<b>G06, general events, part 7, response grades configuration change</b>													
000	X01	003	A11	006	A22	009	C01	012	D02	015	F01	018	G02
001	X02	004	A12	007	B01	010	C02	013	E01	016	F02	019	Res.
002	X03	005	A21	008	B02	011	D01	014	E02	017	G01	020	Res.
<b>G07, general events, part 8, sensing tube monitoring configuration change</b>													
000	W00	004	W04	008	W08	012	Res.	016	Res.	020	Res.	024	Res.
001	W01	005	W05	009	W09	013	Res.	017	Res.	021	Res.	025	Res.
002	W02	006	W06	010	Res.	014	Res.	018	Res.	022	Res.	026	Res.
003	W03	007	W07	011	Res.	015	Res.	019	Res.	023	Res.	027	Res.
<b>G08, general events, part 9, sensing tube On/Off via EasyConfig</b>													
001		Sensing tube I deactivated via "EasyConfig"											
002		Sensing tube II deactivated via "EasyConfig"											
004		Sensing tube I activated via "EasyConfig"											
008		Sensing tube II activated via "EasyConfig"											
<b>G10, sensing tube I events, sensing tube alarms</b>													
001		Diff alarm, sensing tube I											
002		Pre-signal Diff alarm, sensing tube I											
004		Max alarm, sensing tube I											
008		Pre-signal Max alarm, sensing tube I											
016		Alarm verification, sensing tube I											
<b>G11, ext. temperature sensor I events, alarms, faults</b>													
004		Alarm, external temperature sensor I											
016		External temperature sensor I fault											
032		Invalid parameters, external temperature sensor I											
064		Fault, external temperature sensor I, compensation											
<b>G12, sensing tube I faults, pressure sensor events, step motor</b>													
001		Pressure sensor I fault											
002		Fault undervoltage step motor / LSU I											
004		Invalid parameters, pressure sensor I											
008		Exceedance measuring range positive, pressure sensor I											
016		Exceedance measuring range negative, pressure sensor I											
032		Error control step motor I											
<b>G13, sensing tube I, isolated, part 1, sensing tube test alarms</b>													
001		Isolated Diff alarm, sensing tube I											
002		Isolated pre-signal Diff alarm, sensing tube I											
004		Isolated Max alarm, sensing tube I											
008		Isolated pre-signal Max alarm, sensing tube I											
<b>G14, Sensing tube I, isolated, part 2, test alarms temperature sensor</b>													
004		Isolated alarm, external temperature sensor I											
<b>G15, Sensing tube I, isolated, part 3, switch On/Off</b>													
001		Isolate sensing tube I switched on											
002		Isolate sensing tube I switched off (normal operation)											
<b>G16, Sensing tube I, test triggerings from EasyConfig to FACP (see G18)</b>													
<b>G18, Sensing tube I, test triggerings from "ADW Config" to FACP</b>													
001		Test alarm sensing tube I											
002		Test fault sensing tube I											
004		Test pre-signal sensing tube I											

→→

## Operation

Continuation:

<b>G17, Sensing tube I, test events</b>	
001	Sensing tube I check
002	Adjustment (temperature compensation) sensing tube I
004	Sensing tube I pressure offset
008	Break assumption in sensing tube I
<b>G20, Sensing tube II events, sensing tube alarms</b>	
001	Diff alarm, sensing tube II
002	Pre-signal Diff alarm, sensing tube II
004	Max alarm, sensing tube II
008	Pre-signal Max alarm, sensing tube II
016	Alarm verification, sensing tube II
<b>G21, ext. temperature sensor II events, alarms, faults</b>	
004	Alarm, external temperature sensor II
016	Fault external temperature sensor II
032	Invalid parameters, external temperature sensor II
064	Fault sensing tube II – temperature sensor, compensation
<b>G22, sensing tube II faults, pressure sensor events, step motor</b>	
001	Pressure sensor II fault
002	Fault undervoltage step motor / LSU II
004	Invalid parameters, pressure sensor II
008	Exceedance measuring range positive, pressure sensor II
016	Exceedance measuring range negative, pressure sensor II
032	Error control step motor II
<b>G23, Sensing tube II, isolated, part 1 (sensing tube test alarms)</b>	
001	Isolated Diff alarm, sensing tube II
002	Isolated pre-signal Diff alarm, sensing tube II
004	Isolated Max alarm, sensing tube II
008	Isolated pre-signal Max alarm, sensing tube II
<b>G24, Sensing tube II, isolated, part 2, test alarms temperature sensor</b>	
004	Isolated alarm, external temperature sensor II
<b>G25, Sensing tube II, isolated, part 3, switch On/Off</b>	
001	Isolate sensing tube II switched on
002	Isolate sensing tube II switched off (normal operation)
<b>G26, Sensing tube II, test triggerings from EasyConfig up to FACP (see G28)</b>	
<b>G28, Sensing tube II, test triggerings from "ADW Config" to FACP</b>	
001	Test alarm sensing tube II
002	Test fault sensing tube II
004	Test pre-signal sensing tube II
<b>G27, Sensing tube II test events</b>	
001	Sensing tube II check
002	Adjustment (temperature compensation) sensing tube II
004	Sensing tube II pressure offset
008	Break assumption in sensing tube II
<b>G30, sensing tube I faults, test interruption, crushing, leak, step motor, sensing tube length</b>	
001	Sensing tube I interruption check
002	Sensing tube I crushing check
004	Sensing tube I leakage check
008	Invalid parameter, sensing tube monitoring I
016	Test (check) cancelled, sensing tube I
032	Max. sensing tube length exceeded, sensing tube I
064	Leaking sensing tube I
<b>G40, sensing tube II faults, test interruption, crushing, leak, step motor, sensing tube length</b>	
001	Sensing tube II interruption check
002	Sensing tube II crushing check
004	Sensing tube II leakage check
008	Invalid parameter, sensing tube monitoring II
016	Test (check) cancelled, sensing tube II
032	Max. sensing tube length exceeded, sensing tube II
064	Leaking sensing tube II

→→

Continuation:

<b>G50, initial reset faults sensing tube I</b>	
001	Sealing check I negative (failed)
002	Timeout initial reset I
004	Length check I negative (failed)
008	Initial reset, invalid parameters sensing tube I
016	Interruption I
032	Ur-Reset I cancelled
<b>G60, initial reset faults sensing tube II</b>	
001	Sealing check II negative (failed)
002	Timeout initial reset II
004	Length check II negative (failed)
008	Initial reset, invalid parameters sensing tube II
016	Interruption II
032	Ur-Reset II cancelled
<b>G70, RIM 1, RIM 2 faults</b>	
001	Fault RIM 1, lacking or defective
016	Fault RIM 2, lacking or defective
064	Fault incompatible RIM
128	Fault too many RIMs
<b>G71, XLM faults</b>	
001	Fault XLM, lacking or defective
004	XLM fault, too many XLMs
<b>G72, SD memory card / SIM faults</b>	
001	SD memory card fault, missing or defective
016	Fault SIM, lacking or defective
064	SIM fault, too many SIMs
<b>G80, LMB faults</b>	
001	Operating system fault 1
002	Operating system fault 2
004	Undervoltage fault
008	Clock fault
016	EEPROM fault
032	Invalid parameters, day/night control
064	Fault absolute pressure sensor

# Operation

## 8.5.5 Operation and displays on the XLM 35

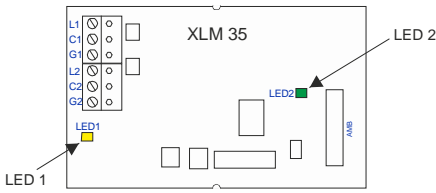

Fig. 36 XLM 35 operation and display

LED 1 (yellow)	State XLM 35 <-> addressable loop (lights only if supply from LMB is OK)
Not lit	No addressable loop voltage
Continuously lit	Addressable loop voltage OK, No communication XLM <-> Line
Flashes (normal operation)	Communication XLM <-> Line OK
LED 2 (green)	State ADW 535HDx <-> XLM 35
Not lit	No power supply from LMB 35
Flashes (normal operation)	Power supply from LMB 35 OK, Communication XLM <-> ADW OK

## 8.5.6 Operation and display on the SIM 35

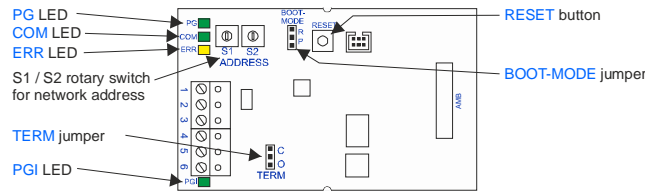

Fig. 37 SIM 35 operation and display

The functions of the rotary switches, jumpers, buttons and LEDs are shown in the following table.

The network address is set in hexadecimal code using the two rotary switches (S1 and S2). The bus termination is defined with the **TERM** jumper. This must be performed on **both sides of the network** (beginning and end). The **BOOT-MODE** jumper is used only in production. The **RESET** button initiates a HW reset on the SIM 35. The four LEDs on the SIM 35 indicate the state of the ADW network. Please refer to Sec. 11.2 for more information about the ADW network.

Rotary switch S1 / S2		Network address							
Dec	Hex	Dec	Hex	Dec	Hex	Dec	Hex	Dec	Hex
		32 2 0	64 4 0	96 6 0	128 8 0	160 A 0	192 C 0	224 E 0	
1	0 1	33 2 1	65 4 1	97 6 1	129 8 1	161 A 1	193 C 1	225 E 1	
2	0 2	34 2 2	66 4 2	98 6 2	130 8 2	162 A 2	194 C 2	226 E 2	
3	0 3	35 2 3	67 4 3	99 6 3	131 8 3	163 A 3	195 C 3	227 E 3	
4	0 4	36 2 4	68 4 4	100 6 4	132 8 4	164 A 4	196 C 4	228 E 4	
5	0 5	37 2 5	69 4 5	101 6 5	133 8 5	165 A 5	197 C 5	229 E 5	
6	0 6	38 2 6	70 4 6	102 6 6	134 8 6	166 A 6	198 C 6	230 E 6	
7	0 7	39 2 7	71 4 7	103 6 7	135 8 7	167 A 7	199 C 7	231 E 7	
8	0 8	40 2 8	72 4 8	104 6 8	136 8 8	168 A 8	200 C 8	232 E 8	
9	0 9	41 2 9	73 4 9	105 6 9	137 8 9	169 A 9	201 C 9	233 E 9	
10	0 A	42 2 A	74 4 A	106 6 A	138 8 A	170 A A	202 C A	234 E A	
11	0 B	43 2 B	75 4 B	107 6 B	139 8 B	171 A B	203 C B	235 E B	
12	0 C	44 2 C	76 4 C	108 6 C	140 8 C	172 A C	204 C C	236 E C	
13	0 D	45 2 D	77 4 D	109 6 D	141 8 D	173 A D	205 C D	237 E D	
14	0 E	46 2 E	78 4 E	110 6 E	142 8 E	174 A E	206 C E	238 E E	
15	0 F	47 2 F	79 4 F	111 6 F	143 8 F	175 A F	207 C F	239 E F	
16	1 0	48 3 0	80 5 0	112 7 0	144 9 0	176 B 0	208 D 0	240 F 0	
17	1 1	49 3 1	81 5 1	113 7 1	145 9 1	177 B 1	209 D 1	241 F 1	
18	1 2	50 3 2	82 5 2	114 7 2	146 9 2	178 B 2	210 D 2	242 F 2	
19	1 3	51 3 3	83 5 3	115 7 3	147 9 3	179 B 3	211 D 3	243 F 3	
20	1 4	52 3 4	84 5 4	116 7 4	148 9 4	180 B 4	212 D 4	244 F 4	
21	1 5	53 3 5	85 5 5	117 7 5	149 9 5	181 B 5	213 D 5	245 F 5	
22	1 6	54 3 6	86 5 6	118 7 6	150 9 6	182 B 6	214 D 6	246 F 6	
23	1 7	55 3 7	87 5 7	119 7 7	151 9 7	183 B 7	215 D 7	247 F 7	
24	1 8	56 3 8	88 5 8	120 7 8	152 9 8	184 B 8	216 D 8	248 F 8	
25	1 9	57 3 9	89 5 9	121 7 9	153 9 9	185 B 9	217 D 9	249 F 9	
26	1 A	58 3 A	90 5 A	122 7 A	154 9 A	186 B A	218 D A	250 F A	
27	1 B	59 3 B	91 5 B	123 7 B	155 9 B	187 B B	219 D B		
28	1 C	60 3 C	92 5 C	124 7 C	156 9 C	188 B C	220 D C		
29	1 D	61 3 D	93 5 D	125 7 D	157 9 D	189 B D	221 D D		
30	1 E	62 3 E	94 5 E	126 7 E	158 9 E	190 B E	222 D E		
31	1 F	63 3 F	95 5 F	127 7 F	159 9 F	191 B F	223 D F		

Jumper <b>TERM</b>	Bus termination (position "C" = active)
Position <b>O</b>	SIM 35 is <b>not</b> first or last module
Position <b>C</b>	SIM 35 is <b>first</b> or <b>last</b> module
Jumper <b>BOOT-MODE</b>	FW upgrade (production)
Position <b>R</b>	Normal position
Position <b>P</b>	Local FW upgrade on the SIM 35
Button <b>RESET</b>	SIM reset
Press	Triggers a HW reset of the SIM 35

LED <b>PG</b> (green)	State of voltage supply
Continuously lit	Power supply from LMB 35 OK
LED <b>PGI</b> (green)	State of internal voltage supply
Continuously lit	Internal voltage supply OK
LED <b>COM</b> (green)	State of communication
Flashes	Communication in progress, "ADW Config" is active
LED <b>ERR</b> (yellow)	State SIM / fault
Flashes	Address is in invalid range
Continuously lit	SIM has fault

8.5.7 Operation and display on the SMM 535



**Use in potentially explosive atmospheres**

When multiple ADW 535HDx units are networked in potentially explosive atmospheres, the master module **SMM 535** must be installed outside of the potentially explosive atmosphere!

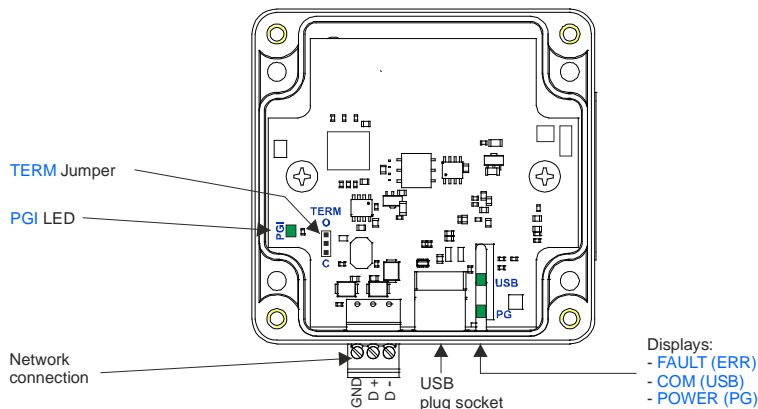

**Fig. 38 SMM 535 operation and display**

The functions of the jumpers and LEDs are shown in the following table.

The bus termination is defined with the **TERM** jumper. This must be performed on **both sides of the network** (beginning and end). The three LEDs on the SMM 535 indicate the state of the ADW network. Two of these are fibre optic cables on the outside of the housing (**FAULT** LED is not fitted, optional).

Jumper <b>TERM</b>	Bus termination (position "C" = active)
Position <b>O</b>	SMM 535 is <b>not</b> first or last module
Position <b>C</b>	SMM 535 is <b>first</b> or <b>last</b> module

<b>POWER (PG) (green)</b>	<b>State of voltage supply</b>
Continuously lit	Power supply from PC (USB) OK
<b>COM (USB) (green)</b>	<b>State of communication</b>
Flashes	Communication in progress, "ADW Config" is active
<b>LED PGI (green)</b>	<b>State of internal voltage supply</b>
Continuously lit	Internal voltage supply OK

No network address has to be assigned to the SMM 535.

**8.6 Operation from SecuriFire / Integral with XLM 35**

When connecting to the SecuriFire or Integral FACP via an **XLM 35**, control operations and changes can be made to the ADW device configuration directly from the FACP. For this purpose the FACP user software "SecuriFire Studio" and "**Integral Application Center**" are used to start the "ADW Config" configuration software for access to the ADWs; the configuration software is then used to operate the ADW 535HDx (**Config over Line**).

# 9 Maintenance and service

## 9.1 General



### Notices

- Maintenance and service work on fire alarm systems are subject in part to country-specific laws and directives.
- Maintenance and service work may be performed only by persons trained and authorised by the manufacturer of the ADW 535HDx.



### Use in potentially explosive atmospheres

The applicable regulations of [BetrSichV](#) and VDE 0165, IEC 60079-14 for servicing, maintenance and testing must be observed!

Because of the danger of electrostatic charges, only a damp cloth or sponge may be used to clean this operating material.

Operating material for servicing and maintenance must be suitable for the explosion hazardous environment.

## 9.2 Cleaning

Clean the evaluation unit with a **non-aggressive** cleaning agent (e.g. soap suds or similar).

The sensing tube needs no cleaning to function properly.



### Notice

Aggressive cleaning agents (such as solvents, pure petrol or other alcohol-based agents) must not be used for cleaning.

### 9.3 Maintenance checks and function checks



#### Notice

To avoid triggering fire incident controls, remote alerting and extinguishing areas when carrying out maintenance work, it is **essential** to block or switch off those systems beforehand.



#### Use in potentially explosive atmospheres

##### Testing with heat EXPLOSION HAZARD!

Testing the response characteristics of the ADW 535HDx by means of effective fire characteristic “heat” (hot air blower) is not possible due to the potentially explosive atmosphere (see also Sec. 7.7.2).

If required, it is possible to generate the necessary heat (similar to an actual fire) with hot water or steam to simulate the response of the ADW 535HDx (test coil, see also Sec. 5.4.2.4).

Owing to the automatic sealing test and the self-monitoring of ADW switching, periodic function checks are unnecessary as a rule. The statutory national directives (e.g. DIN VDE 0833-1, [VKF](#)) governing maintenance must be observed on the ADW 535HDx.

Servicing, maintenance or inspection work on the ADW 535HDx may be necessary after an event (fire, fault).

If a evaluation unit has to be replaced due to a defect, the new ADW 535HDx must undergo the same procedure as if a first-time commissioning (initial reset required). When replacing the ADW 535HDx, all customer-specific configurations have to be carried out again.

The following points have to be carried out for service checks and functional checks. All measurements and tests carried out are to be entered and signed for in the commissioning protocol. The completed commissioning protocol is to be stored with the ADW. If required, a copy can be made and stored in the system dossier.

1. Block or switch off fire incident control and remote alerting on superordinate FACPs.
2. Check that the supply voltage on the FACP is set in compliance with maintenance instructions for the control panel.
3. Open the cover of the evaluation unit. Carry out the following measurements:
  - Measure operating voltage on terminals 1 (+), 2 (-) → target value = 10.8 to 13.8 VDC (in 12 VDC operation) or 21.6 to 27.6 VDC (in 24 VDC operation).
  - Read out the set configuration and the pressure values for each sensing tube of switch position **P** (see Sec. 7.6.1) and compare with the commissioning protocol.
4. Check fault triggering, alarm release and correct alarm transmission to the FACP as described in Sec. 7.6.2. Log the completed tests in the commissioning protocol.
5. If maintenance or repair work was carried out on the ADW 535HDx (including the sensing tube) as a result of a servicing check, a new initial reset may be necessary (see Sec. 7.3.5).
6. All measurements and tests carried out are to be entered and signed for in the commissioning protocol. The completed commissioning protocol is to be stored with the ADW. If required, a copy can be made and stored in the system dossier.
7. After completion of the servicing check, close the evaluation unit once again.

## 9.4 Replacing units



### Notice

Defective units such (e.g. LMB 35, LSU 35) may be replaced only in the de-energised state (with terminal block 1/2 and possibly 3/4 unplugged from the LMB 35).



### Use in potentially explosive atmospheres

Prior to performing repairs and replacing parts on the ADW 535HDx (printed circuit board, supervising unit), the FACP and the local power (if present) of the ADW 535HDx must be de-energised – the line (loop) deactivated and the 24 VDC power supply of the ADW 535HDx switched off. Before carrying out any interventions on the ADW 535HDx it is necessary to check (measure) that the ADW 535HDx is no longer energised (terminal 1 and 2 or 3 and 4 on the LMB 35, and line terminals on control module / alarm transmitter).

### 9.4.1 Replacing the LSU 35 supervising unit

To replace the LSU 35 supervising unit, the LMB 35 main board must be removed. The LEB 35 (for ADW 535-2HDx) can remain on the LMB 35. All internal connectors to the LSU 35 (Motor / Sens) as well as any additional modules (RIM / XLM etc.) must be carefully removed beforehand. Plug-in terminals 1 to 21 (and 22 to 31 for LEB 35) do not necessarily need to be pulled out. After removing the 5 fastening screws **A** of the LMB 35 with a **no. 1 Phillips-head screwdriver**, the LMB 35 can be lifted up toward the cable entries to make the fastening screws of the LSU 35 supervising unit accessible. To remove the LSU 35, first undo the sensing tube and take off the union nut **C** on the outside of the housing with a **no. 12 fork wrench**. Then remove the two screws **D** with a **no. 1 Phillips-head screwdriver** (see Fig. 39).



### Notices

- All other screws on the LSU 35 must **not** be loosened.
- When installing the new LSU 35, **first** ensure the correct positioning of the LSU 35 in the housing by slightly tightening the **union nut C**. Only then tighten the screws **D** as well as the union nut **C** again.
- When installing the LMB 35, make sure the terminal and ribbon cable connector assignments are correct (see also Fig. 6).
- After replacing the supervising unit, a **new initial reset** is imperative (see Sec. 7.3.5).

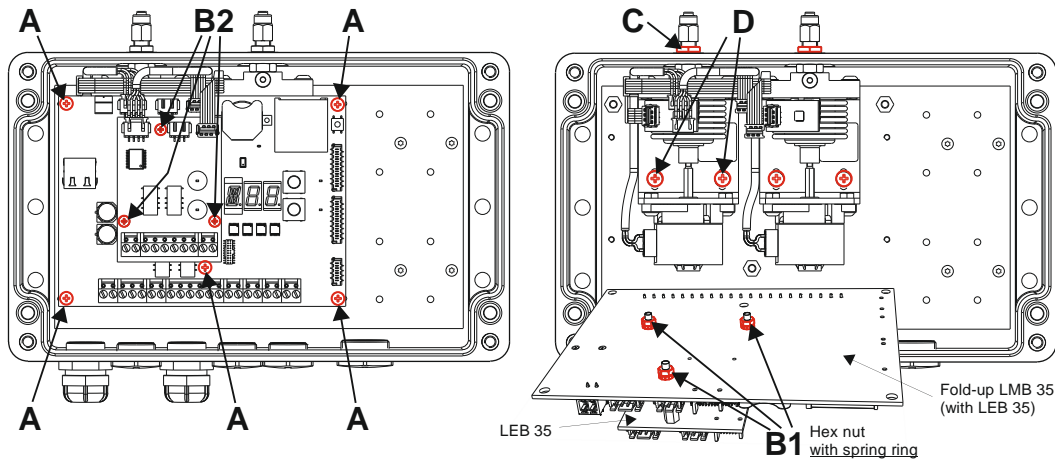

Fig. 39 Removing LSU 35, LMB 35 and LEB 35

### 9.4.2 Replacing the LMB 35 main board

To replace the LMB 35 main board, unplug all of the plug-in terminals (with installation wires). For the ADW 535-2HDx this also applies to the terminals of the LEB 35. All internal connectors to the LSU 35 (Motor / Sens – also from the LEB 35) as well as any additional modules (RIM / XLM etc.) must also be carefully removed. After removing the 5 fastening screws **A** of the LMB 35 with a **no. 1 Phillips-head screwdriver**, the LMB 35 can be removed from the evaluation unit (see **Fig. 39**). If there is an LEB 35 extension board on the LMB 535, it must be removed by taking off the three hexagon nuts **B1** with a **no. 5.5 fork wrench** from the rear side of the LMB and attached to the new LMB 35 in the same way. **Important:** Use the 3 spring rings again for the new LMB. The new LMB 35 can then be mounted in the evaluation unit. All cable connections must be re-established.



#### Notices

- When connecting the new LMB 35, take note of the correct assignment of the terminals and ribbon cable connectors (see **Fig. 6**).
- After replacing the LMB 35, a **new initial reset** is imperative (see Sec. 7.3.5). Likewise, all customer-specific configurations and project-specific settings from the “ADW HeatCalc” configuration software must be carried out once again. To do so, proceed according to Sec. 7.3.1 and 7.3.2.
- After replacing the LMB 35, it is imperative to **check alarm transmission** as described in Sec. 7.7.1 (on ADW 535-2HDx for alarm 1 and alarm 2).

### 9.4.3 Replacing LEB 35 extension board

To replace the LEB 35 extension board, unplug the plug-in terminals 22 to 31 with installation wires. Also carefully undo the internal connections to the LSU 35 (Motor2 / Sens2). After removing the 3 fastening screws **B2** with a **no. 1 Phillips screwdriver**, the LEB 35 can be removed from the LMB 35 and replaced by the new LEB 35 (see **Fig. 39**). All cable connections must be re-established.



#### Notices

- When connecting the new LEB 35, take note of the correct assignment of the terminals and ribbon cable connectors (see **Fig. 6**).
- After replacing the LEB 35, it is imperative to **check alarm transmission** as described in Sec. 7.7.1 (for alarm 1 and alarm 2).

### 9.5 Disposal

The ADW 535HDx line type heat detector and its packaging consist of recyclable material that can be disposed of as described in Sec. 9.5.1.

#### 9.5.1 Materials used



#### Recycling



All the raw materials and other materials used in the ADW 535HDx and all the technologies used in manufacturing are ecologically and environmentally friendly in compliance with ISO 14000.

All waste resulting from assembly (packaging and plastic parts) can be recycled and should be disposed of accordingly.

Devices, sensing tubes or parts thereof that are no longer used should be disposed of in an environmentally-friendly manner.

The manufacturer of the ADW 535HDx is obliged to take back any devices and sensing tubes for eco-friendly disposal that are defective or no longer used. For this purpose the manufacturer has implemented a monitored and approved disposal system. This service is available worldwide at cost price.

#### Materials used in the ADW 535HDx:

Evaluation unit	Glass-fibre reinforced, duroplastic polyester
LSU 35 supervising unit	St / Cu / CuZn
Circuit boards, general	Epoxy resin hard paper
Soldering process	Environmentally-friendly manufacturing compliant with RoHS
Foil on housing front	PE
Sensing tube	Cu / St / PTFE / PA
Connections	CuZn / St / PVDF
Pipe clamps	PP /St / CuZn

## 10 Faults

### 10.1 General

When troubleshooting, do not make any on-site modifications to the printed circuit boards. This applies in particular to replacing or changing soldered components. Defective printed circuit boards and units are to be completely replaced by the corresponding spare part according to Sec. 12.1. No repairs of defective printed circuit boards or units will be undertaken by the manufacturer. It is nevertheless possible to return complete ADW devices to be checked if there is a complaint or if a guarantee is the issue.



#### Notice

Printed circuit boards are to be replaced or changed only by trained and qualified personnel. Handling is permissible only when the measures for protection against electrostatic discharge are observed and heeded.



#### Use in potentially explosive atmospheres

Whenever faults are to be rectified on the ADW 535HDx, the potentially explosive environment must be taken into consideration. Essentially, safety precautions must be taken when undertaking interventions on the ADW 535HDx during operation; it must be ensured that work on the ADW 535HDx does not present an explosion hazard (check the Ex-values, switch off voltage, use appropriate measuring and testing devices, caution when using a PC).

Prior to performing repairs and replacing parts on the ADW 535HDx (printed circuit board, supervising unit), the FACP and the local power (if present) of the ADW 535HDx must be de-energised – the line (loop) deactivated and the 24 VDC power supply of the ADW 535HDx switched off. Before carrying out any interventions on the ADW 535HDx it is necessary to check (measure) that the ADW 535HDx is no longer energised (terminal 1 and 2 or 3 and 4 on the LMB 35, and line terminals on control module / alarm transmitter).

### 10.2 Warranty claims

Failure to observe the aforementioned rules of conduct will invalidate any warranty claims and manufacturer's liability for the ADW 535HDx.



#### Notices

- Repairs to the device or parts thereof are to be carried out only by personnel trained by the manufacturer. Non-observance of this regulation results in the invalidation of warranty claims and the manufacturer's liability concerning the ADW 535HDx.
- All repairs and troubleshooting measures are to be documented.
- The ADW 535HDx must undergo a function check following a repair or troubleshooting measure.

## 10.3 Finding and rectifying faults

### 10.3.1 Fault states

With the aid of the event memory and the relevant event code display (can be called up with the segment display on the LMB 35, switch position **E**), it is possible to localize the error in the event of a fault. The following table lists the event codes of possible fault states and how to rectify them. Because the codes are the same for sensing tubes I and II, they are listed together. For this reason it is important to note the relevant event group (e.g. **G10** or **G20**). A list of all event codes is provided in Sec. 8.5.4.3.



### Notice

**Multiple codes:** If there are multiple events for any given event group, the display readings are added together.  
Example: Display **012** = event code **004** and **008**.

<b>G04, temperature sensor LMB faults</b>			
Code	Meaning	Check:	Possible causes and remedy:
<b>016</b>	Fault temperature sensor LMB	LMB, temperature sensor	<ul style="list-style-type: none"> <li>LMB defective → replace</li> </ul>
<b>032</b>	Invalid parameter, LMB temperature sensor (production fault)	LMB, temperature sensor	<ul style="list-style-type: none"> <li>LMB defective → replace</li> </ul>
<b>G11 or G21, temperature sensor I / II faults</b>			
Code	Meaning	Check:	Possible causes and remedy:
<b>016</b>	Fault, external temperature sensor	Connection cable, terminals LMB, LEB, temperature sensor	<ul style="list-style-type: none"> <li>Connection cable not correctly connected or defective → check, replace</li> <li>Temperature sensor defective → replace</li> <li>LMB (or LEB) defective → replace</li> </ul>
<b>032</b>	Invalid parameters, external temperature sensor (production fault)	Connection cable, terminals LMB, LEB, temperature sensor	<ul style="list-style-type: none"> <li>Connection cable not correctly connected or defective → check, replace</li> <li>Temperature sensor defective → replace</li> <li>LMB (or LEB) defective → replace</li> </ul>
<b>064</b>	Fault sensing tube – temperature sensor, compensation	Connection cable, terminals LMB, LEB, temperature sensor, configuration	<ul style="list-style-type: none"> <li>Connection cable not correctly connected or defective → check, replace</li> <li>Temperature sensor defective → replace</li> <li>LMB (or LEB) defective → replace</li> <li>Configuration → check</li> </ul>
<b>G12 or G22, pressure sensor I / II faults</b>			
Code	Meaning	Check:	Possible causes and remedy:
<b>001</b>	Pressure sensor fault	Ribbon cable connection LMB, LEB, pressure sensor (LSU)	<ul style="list-style-type: none"> <li>Ribbon cable not correctly attached or defective → check, replace</li> <li>Pressure sensor defective → replace LSU</li> <li>LMB (or LEB) defective → replace</li> </ul>
<b>002</b>	Undervoltage fault / LSU	Power supply on the ADW, ribbon cable connection LMB, LEB, step motor (LSU)	<ul style="list-style-type: none"> <li>Conductor cross-section to the ADW not sufficiently dimensioned</li> <li>Ribbon cable not correctly attached or defective → check, replace</li> <li>Step motor defective → replace LSU</li> <li>LMB (or LEB) defective → replace</li> </ul>
<b>004</b>	Invalid parameters, pressure sensor (production fault)	Pressure sensor	<ul style="list-style-type: none"> <li>Replace LSU</li> </ul>
<b>008</b>	Exceedance measuring range positive, pressure sensor	Use, application (high ambient temperature)	<ul style="list-style-type: none"> <li>Observance of the minimum temperature for initial reset</li> </ul>
<b>016</b>	Exceedance measuring range negative, pressure sensor	Use, application (high ambient temperature)	<ul style="list-style-type: none"> <li>Observance of the minimum temperature for initial reset</li> </ul>
<b>032</b>	Actuation error step motor	Voltage supply on the ADW	<ul style="list-style-type: none"> <li>Conductor cross-section to the ADW not sufficiently dimensioned</li> </ul>

→→

Continuation:

<b>G30 or G40, test faults, sensing tube I / II</b>			
<b>Code</b>	<b>Meaning</b>	<b>Check:</b>	<b>Possible causes and remedy:</b>
001	Sensing tube interruption check	Sensing tube, screw-junction pieces (also on end of sensing tube), transitions, Connection on ADW, Connection to step motor on LSU	<ul style="list-style-type: none"> <li>• Check sensing tube for interruption (screw-junction pieces, transitions, connection on ADW)</li> <li>• Sealing check if necessary, check for leak (leak detection spray) acc. to Sec. 5.4.2.5</li> <li>• Defective or loose connection to step motor (LSU)</li> <li>• Initial reset after fault is rectified</li> </ul>
002	Sensing tube crushing check	Sensing tube, transitions from flexible hose to metal pipe (in junction boxes), radii at direction change too small	<ul style="list-style-type: none"> <li>• Check sensing tube for crushing (transitions in junction boxes, radii)</li> <li>• Initial reset after fault is rectified</li> </ul>
004	Sensing tube leakage check	Sensing tube, screw-junction pieces (also on end of sensing tube), transitions, Connection on ADW	<ul style="list-style-type: none"> <li>• Check sensing tube for interruption (screw-junction pieces, transitions, connection on ADW)</li> <li>• Sealing check if necessary, check for leak (leak detection spray) acc. to Sec. 5.4.2.5</li> <li>• Initial reset after fault is rectified</li> </ul>
008	Invalid parameters, sensing tube monitoring	LSU supervising unit	<ul style="list-style-type: none"> <li>• Ribbon cable not correctly attached or defective → check, replace</li> <li>• Pressure sensor defective → replace LSU</li> <li>• LMB (or LEB) defective → replace</li> </ul>
016	Test (check) cancelled, sensing tube	Voltage supply on the ADW	<ul style="list-style-type: none"> <li>• Conductor cross-section to the ADW not sufficiently dimensioned</li> </ul>
032	Max. sensing tube length exceeded, sensing tube	Sensing tube length	<ul style="list-style-type: none"> <li>• Check sensing tube length</li> <li>• Adjust sensing tube length</li> </ul>
064	Leaking sensing tube <b>Remark:</b> The origin of this fault is not due to normal "testing" and is therefore not recognisable but rather by extended monitoring algorithms.	Sensing tube, screw-junction pieces (also on end of sensing tube), transitions, connection on ADW.	<ul style="list-style-type: none"> <li>• Check sensing tube for interruption (screw-junction pieces, transitions, connection on ADW)</li> <li>• Sealing check if necessary, check for leak (leak detection spray) acc. to Sec. 5.4.2.5</li> <li>• Initial reset after fault is rectified (when using the "ADW Config" application, mandatory with "sealing check")</li> </ul>
<b>G50 or G60, initial reset faults sensing tube I / II</b>			
<b>Code</b>	<b>Meaning</b>	<b>Check:</b>	<b>Possible causes and remedy:</b>
001	Sealing check negative (failed)	Sensing tube, screw-junction pieces (also on end of sensing tube), transitions, Connection on ADW	<ul style="list-style-type: none"> <li>• Check sensing tube for interruption (screw-junction pieces, transitions, connection on ADW)</li> <li>• Sealing check if necessary, check for leak (leak detection spray) acc. to Sec. 5.4.2.5</li> <li>• Initial reset after fault is rectified</li> </ul>
002	Timeout initial reset	LSU supervising unit	<ul style="list-style-type: none"> <li>• Ribbon cable not correctly attached or defective → check, replace</li> <li>• Pressure sensor defective → replace LSU</li> <li>• LMB (or LEB) defective → replace</li> </ul>
004	Length check negative (failed)	Sensing tube length specification incorrectly programmed (EasyConfig or "ADW Config"), wrong dimension of the mounted sensing tube length, possibly sensing tube I and II reversed, possibly leak in the sensing tube, possibly different temperature between sensing tube and ADW	<ul style="list-style-type: none"> <li>• Check dimension (installed length)</li> <li>• Sensing tube assignment (I / II) check</li> <li>• Check programming (length specification)</li> <li>• Sealing check if necessary, check for leak (leak detection spray) acc. to Sec. 5.4.2.5</li> <li>• Reduce the sensitivity of the tube monitoring</li> <li>• Carry out an initial reset without length test ("ADW Config")</li> </ul>

→→

## Faults

Continuation:

008	Initial reset, invalid parameters sensing tube	LSU supervising unit Sensing tube length	<ul style="list-style-type: none"> <li>Ribbon cable not correctly attached or defective → check, replace</li> <li>Pressure sensor defective → replace LSU</li> <li>LMB (or LEB) defective → replace</li> <li>The configured sensing tube length was changed → perform new initial reset</li> </ul>
016	Interruption	Sensing tube, screw-junction pieces (also on end of sensing tube), transitions, Connection on ADW	<ul style="list-style-type: none"> <li>Check sensing tube for interruption</li> <li>Sealing check if necessary, check for leak (leak detection spray) acc. to Sec. 5.4.2.5</li> <li>Initial reset after fault is rectified</li> </ul>
032	Initial reset interrupted	Voltage supply on the ADW	<ul style="list-style-type: none"> <li>Conductor cross-section to the ADW not sufficiently dimensioned</li> </ul>
<b>G70, RIM 1, RIM 2 faults</b>			
<b>Code</b>	<b>Meaning</b>	<b>Check:</b>	<b>Possible causes and remedy:</b>
001	Fault RIM 1, lacking or defective	Ribbon cable connection	<ul style="list-style-type: none"> <li>Ribbon cable not correctly attached or defective → check, replace</li> <li>Module removed and not logged off</li> <li>Module defective → replace</li> </ul>
016	Fault RIM 2, lacking or defective	Module	
064	Fault incompatible RIM	Note the production version, should be greater than 181214	<ul style="list-style-type: none"> <li>Exchange RIM</li> </ul>
128	RIM fault, too many RIMs	Number of RIMs	<ul style="list-style-type: none"> <li>Only 2 RIMs permitted!</li> </ul>
<b>G71, XLM faults</b>			
<b>Code</b>	<b>Meaning</b>	<b>Check:</b>	<b>Possible causes and remedy:</b>
001	Fault XLM, lacking or defective	Ribbon cable connection Module	<ul style="list-style-type: none"> <li>Ribbon cable not correctly attached or defective → check, replace</li> <li>Module removed and not logged off</li> <li>Module defective → replace</li> </ul>
004	XLM fault, too many XLMs	Number of XLMs	<ul style="list-style-type: none"> <li>Only 1 XLM permitted!</li> </ul>
<b>G72, SD memory card / SIM faults</b>			
<b>Code</b>	<b>Meaning</b>	<b>Check:</b>	<b>Possible causes and remedy:</b>
001	SD memory card fault, missing or defective	SD memory card	<ul style="list-style-type: none"> <li>SD memory card lacking or not snapped in</li> <li>SD memory card was removed without logging off</li> <li>SD memory card defective → replace</li> </ul>
016	Fault SIM, lacking or defective	Ribbon cable connection Module	<ul style="list-style-type: none"> <li>Ribbon cable not correctly attached or defective → check, replace</li> <li>Module removed and not logged off</li> <li>Module defective → replace</li> </ul>
064	SIM fault, too many SIMs	Number of SIMs	<ul style="list-style-type: none"> <li>Only 1 SIM permitted!</li> </ul>
<b>G80, LMB faults</b>			
<b>Code</b>	<b>Meaning</b>	<b>Check:</b>	<b>Possible causes and remedy:</b>
001	Operating system fault 1	LMB	<ul style="list-style-type: none"> <li>LMB defective → replace</li> </ul>
002	Operating system fault 2	LMB	<ul style="list-style-type: none"> <li>LMB defective → replace</li> </ul>
004	Undervoltage fault	Operating voltage < 8.5 VDC Conductor cross-section	<ul style="list-style-type: none"> <li>conductor cross-section too weak → must be enlarged</li> <li>Voltage of the power supply not OK → check and correct if needed</li> </ul>
008	Clock fault	Lithium battery Clock setting	<ul style="list-style-type: none"> <li>Isolation strip still present on the lithium battery → remove</li> <li>Clock is not set</li> <li>Lithium battery defective → replace</li> </ul>
016	EEPROM fault	LMB	<ul style="list-style-type: none"> <li>Execute HW reset</li> <li>LMB defective → replace</li> </ul>
032	Invalid parameters, day/night control	Day/night control configuration LMB	<ul style="list-style-type: none"> <li>Re-configure day/night control ("ADW Config")</li> <li>LMB defective → replace</li> </ul>

# 11 Options

## 11.1 Use in potentially explosive atmospheres



### Use in potentially explosive atmospheres

For deployment in potentially explosive atmospheres the following information must be strictly observed (see also Sec. 5.4.2):

- If the complete line type heat detector (incl. evaluation unit) has to be installed **in the danger zone**, it is **absolutely necessary** that the **ADW 535-1HDx** or **ADW 535-2HDx** version is used. However, they may be used **only** in **Ex zones 2** and **22**.
- When using the **ADW 535-1** and **ADW 535-2** versions, **only** the sensing tube may be used in the danger zone. The ADW 535 evaluation unit **must** be installed **outside of the Ex-zone** in the safe area.
- The evaluation unit **ADW 535-1HDx** and **ADW 535-2HDx** line type heat detectors **must not** be installed in **zones 0, 1, 20** and **21** potentially explosive atmospheres.
- The sensing tube may be conveyed in zones 0, 20, 1 and 21 after consulting with the responsible offices. When using in these Ex-zones, **only** the sensing tube is permitted in the zone. The ADW 535HDx evaluation unit must be installed outside Ex zones 0, 20, 1 or 21 (in zone 2, 22 or in the safe area).
- **Exception:** After consulting with the manufacturer of the ADW 535HDx there is the possibility of deploying the ADW 535HDx in **Ex zones 1** and **21** if specially tested and approved ADW housings are used. Such areas of application and device versions may be subject to country-specific tests in some cases and therefore must be approved by the responsible authorities and licensing offices. Any consultations with the responsible country-specific approval and test offices are to be carried out by the manufacturer of the ADW 535HDx.
- The evaluation unit and the sensing tube must **always** be connected by appropriate means to the **equipotential bonding** (earthing clamp)
- The **non-Ex-approved ART 535** external temperature sensor **is permitted** to be installed in **Ex zones 2** and **22**. If deployment is necessary in other Ex zones, the Ex approved temperature sensor **ART 535-30 400 °C/EX 1** or **/ EX 21** is to be used **after consulting with the manufacturer** (see also Sec. 6.5.6).
- **Attention:** When using the **ART 535-30 400°C / EX 1** or **/ EX 21** it is **imperative** when mounting to ensure that only the **tip of the sensor** is located in the Ex-zone.

## 11.2 ADW networking

An ADW network can be implemented by using the SIM 35 and SMM 535 additional modules via an RS485 interface. An ADW network can also be implemented via the Ethernet interface directly from the ADW 535HDx (LMB 35). A combination of both principles is possible, but the maximum number of 250 participants in the overall network must be adhered to.



### Notices

- The normative alarm transmission of the ADW 535HDx to the superordinate centre does not take place via the ADW network. For that purpose the “Alarm” / “Fault” relays in the ADW or the SecuriFire / Integral addressable loop are to be used from the XLM 35.
- The ADW network cannot be combined with the ASD network.

### 11.2.1 ADW networking via RS485 interface from SIM 35

Several ADWs can be networked with each other using the SIM 35 additional module. An ADW network can have up to 250 participants. The SMM 535 is necessary as master module in the ADW network and enables the connection to a PC. Using the “ADW Config” configuration software, all ADW 535HDx units present in the network can be configured, visualised and operated from the PC. The SIM 35 provides galvanic separation between the RS485 interface and the LMB 35 (ADW 35HDx).



### Use in potentially explosive atmospheres

When multiple ADW 535HDx units are networked in potentially explosive atmospheres, the master module **SMM 535 must be installed outside** of the potentially explosive atmosphere!

Each SIM 35 and ADW 535HDx is assigned its own address. They are assigned based on the wiring topology in **ascending order** (see also **Fig. 40**).

The SIM 35 has two rotary switches (S1 and S2) for setting the network address (see Sec. 8.5.6).

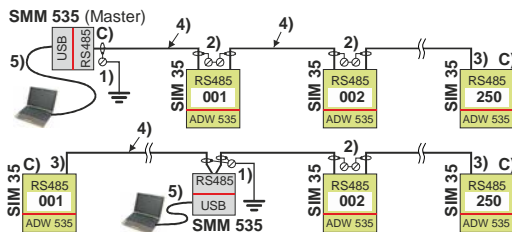

Fig. 40 Design of an RS485 ADW network

- 1) Screen with equipotential bonding connected, always only on the SMM 535, do not connect on the last SIM 35; **3**)
  - 2) Screen connected by means of a lustre terminal.
  - 3) If SMM 535 is within the network, do not connect the screen on the first and last SIM 35 (beginning and end).
  - 4) Network cable: 4-wire, twisted / screened (only 3 wires are used, total length max. 1,000 m).
  - 5) USB cable, max. 3 m in length.
- C) There must be bus termination on both sides of the network (beginning and end); jumper “**TERM**”, position “**C**”.

### 11.2.2 ADW networking via Ethernet interface from LMB 35

Via the Ethernet interface directly from the ADW 535HDx (LMB 35) several ADWs can be networked amongst themselves. An ADW network can have up to 250 participants. The general rules of Ethernet technology apply with respect to a possible constellation and the design. The following example shows one possible alternative for ADW networking via an Ethernet interface.



#### Notice

It is the responsibility of the system operator and/or user of the special fire detector system to ensure IT security.

The following example shows one possible alternative for ADW networking via an Ethernet interface.



#### Use in potentially explosive atmospheres

When multiple ADW 535HDx units are networked in potentially explosive atmospheres, the **Ethernet switch module** and the **PC** may be installed or placed **only outside** the potentially explosive atmosphere!

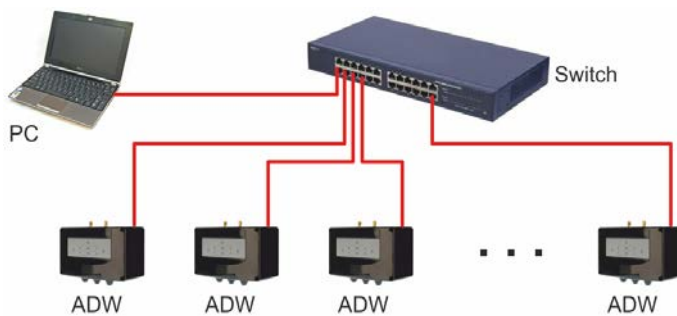

Fig. 41 Design of an Ethernet ADW network

#### Important notice about commissioning:

- The line length between the participants as shown in Fig. 41 (switch – ADW / switch – PC) is a maximum of 100 m.
- If longer lines are required, use fibre optics technology.
- Every ADW requires its own IP address (ex-works 169.254.1.1). The IP address must be uniquely assigned within the network and must be within the valid range (see Sec. 7.1.1.3).
- The IP address is not assigned automatically. Therefore, for assigning the IP address the initial commissioning must take place directly point-to-point on the device for each ADW (“ADW Config” > menu item “**Connection**” > “**Edit address**”, see Sec. 7.1.1.1).
- Details about establishing a connection can be found in Sec. 7.1.1.1 to 7.1.1.3.

## 12 Article numbers and spare parts

### 12.1 Evaluation unit and accessories

Designation	Article no.
ADW 535-1HDx line type heat detector, for 1 sensing tube	11-1000001-01-XX
ADW 535-2HDx line type heat detector, for 2 sensing tubes	11-1000001-02-XX
ADW 535-1 line type heat detector, for 1 sensing tube (standard version)	11-1000000-01-XX
ADW 535-2 line type heat detector, for 2 sensing tubes (standard version)	11-1000000-02-XX
SecuriLine eXtended module XLM 35 incl. installation set (not UL/ULC tested)	11-2200003-01-XX
RIM 36 relay interface module incl. mounting set	11-2200005-01-XX
SIM 35 serial interface module incl. installation set	11-2200000-01-XX
Serial Master Module SMM 535	11-2200001-01-XX
ART 535-10 external temperature sensor	11-1000002-10-XX
ART 535-10 / 400 °C external temperature sensor	50-0500176-01-XX
ART 535-30 400 °C / EX 1 external temperature sensor (see also Sec. 6.5.6 and 11.1)	50-0500176-03-XX
ART 535-30 400 °C / EX 21 external temperature sensor (see also Sec. 6.5.6 and 11.1)	50-0500176-04-XX
Ethernet cable 3.0 m	30-6800006-02-XX
SD memory card (industrial version)	11-1300003-01-XX
Printed LMB 35 main circuit board (for ADW 535-1 / -2 / -1HDx / -2HDx)	11-1200001-01-XX
Printed LEB 35 extension board (for ADW 535-2 / -2HDx)	11-1200002-01-XX
Complete LSU 35 supervising unit	11-1200003-01-XX
Lithium battery BR 2032	11-4000008-01-XX
M20 ATEX cable screw union (set of 10)	11-4000006-01-XX
M25 ATEX cable screw union (set of 10)	11-4000005-01-XX
Adapter for US cable screw union AD US M-inch	11-2300029-01-XX
UMS 35 universal module support	4301252.0101

### 12.2 Sensing tube and accessories

The article numbers of all the available parts for the sensing tube (tubes, screw-junction pieces, etc.) are listed in a separate document (T 140 362).

### 13 Technical data

Type	ADW 535HDx				
Identification according to 2014/34/EU	 II 3G Ex ec nC IIC T4 Gc II 3D Ex tc IIIC T135°C Dc				
Supply voltage range	9 to 30 (UL/FM = 10.6 to 27)				VDC
Maximum power consumption measured at →	in 12 VDC operation	in 24 VDC operation	typical		
	9 VDC ①	18 VDC ①	24 VDC		
ADW 535-1HDx	Quiescent/fault	approx. 75	approx. 45	Approx. 35	mA
	Alarm I	approx. 90	approx. 52	approx. 42	mA
	Test	approx. 660	approx. 270	approx. 210	mA
	Heating below -20°C	approx. 775	approx. 360	approx. 275	mA
ADW 535-2HDx	Quiescent/fault	approx. 95	approx. 53	approx. 43	mA
	Alarm I + II	approx. 125	approx. 71	approx. 57	mA
	Test	approx. 660	approx. 290	approx. 230	mA
	Heating below -20°C	approx. 775	approx. 375	approx. 290	mA
	additionally with 1x RIM 36 (all relays triggered)	approx. 48	approx. 23	approx. 15	mA
	additionally with 2x RIM 36 (all relays triggered)	approx. 96	approx. 46	approx. 30	mA
	additionally with XLM 35 (not UL/ULC tested)	approx. 20	approx. 10	approx. 5	mA
	additionally with SIM 35	approx. 20	approx. 10	approx. 5	mA
	SMM 535 (not from ADW but rather from PC via USB connection)			Max. 100	mA
Switch-on current peak ② (caused by EMC protection elements on the ADW power input)				approx. 5	A
				for max. 1	ms
Sensing tube length					see Sec. 4.5
Sensing tube diameter, copper (Cu), steel (VA) (outer / inner)					diameter 5 / 4 mm
Sensing tube diameter, PTFE (outer / inner)					diameter 6 / 4 mm
Response range	EN 54-22, classes A1I – GI / UL/ULC, acc. to cl. A1I – GI NFPA 72, classes <a href="#">Ordinary</a> , <a href="#">Intermediate</a> , <a href="#">High</a> / RVS / KFI				
Protection type compliant with IEC 60529 / EN 60529	66				IP
Ambient conditions compliant with IEC 60721-3-3 / EN 60721-3-3	3K5 / 3Z1				class
Environmental group compliant with EN 54-22	III				group
Extended ambient conditions:					
• Temperature range evaluation unit	-30 – +70 (ATEX -20 – +70)				°C
• Sensing tube temperature range	-40 – +300 (Teflon = -40 – +200) ③				°C
• Max. permissible storage temperature for evaluation unit (without condensation)	-30 – +70				°C
• Humidity ambient condition of evaluation unit (continuous, IP 65)	95				% rel. humidity
• Humidity ambient condition of sensing tube (continuous)	100				% rel. humidity
Max. loading capacity, relay contact	50 (UL / ATEX max. 30)				VDC
	1 (ATEX max. 0.1)				A
	30 (ATEX max. 20)				W
max. loading capacity per OC output (dielectrical strength 30 VDC)	100				mA
Plug-in terminals	2.5				mm <sup>2</sup>
Cable entry for cable Ø	Ø 7 – 13 (M20) / Ø 11 – 17 (M25)				mm
Protection sleeve ART 535-x	Stainless steel V4A 1.4571				
Housing	material	glass-fibre reinforced, duroplastic polyester, UL 94-V0			
	colour	graphite black 9011 / platinum grey 7036			RAL
Approvals	EN 54-22 / FM 3210 / UL 521 / ULC-S530-M91 / RVS / KFI				
Dimensions ADW 535-1HDx / -2HDx (W x H x D)	260 x 203 x 134				mm
Weight	ADW 535-1HDx	3.050			g
	ADW 535-2HDx	3.420			g



#### Notices

- ① Power consumption at maximum permitted voltage drop in the electrical installation (guideline value for calculating the conductor cross-section).
- ② May cause the protective circuit to trigger immediately in the case of power supplies with overload protective circuits (primarily in devices with no emergency power supply and output current of < 1.5 A).
- ③ Higher temperature ranges are also possible based on sensing tube material after consultation with the manufacturer. When using the sensing tube at 100°C and above, use metal pipe clamps (see also Sec. 5.3).

## 14 List of figures

Fig. 1	General operating principle .....	18
Fig. 2	Block diagram .....	19
Fig. 3	Workflow for project-related programming.....	20
Fig. 4	ADW 535HDx design .....	30
Fig. 5	Mechanical design.....	31
Fig. 6	Electrical design .....	33
Fig. 7	“ADW HeatCalc” programming interface .....	37
Fig. 8	Definitions of sensing tube lengths .....	38
Fig. 9	Workflow for project-specific programming and adjustment.....	41
Fig. 10	ADW 535-2HDx arrangement in tunnels.....	42
Fig. 11	Tunnel with arched, rounded ceiling.....	42
Fig. 12	Tunnel with flat ceiling .....	42
Fig. 13	Tunnels with flat ceiling, over 3 traffic lanes .....	42
Fig. 14	Space surveillance example.....	43
Fig. 15	Dimensioned drawing, drilling plan for evaluation unit.....	50
Fig. 16	Overview of sensing tube design.....	53
Fig. 17	Example of sensing tube ascent in tunnels.....	54
Fig. 18	Angle of view for sensing tube mounting in tunnels .....	54
Fig. 19	Sensing tube connections .....	55
Fig. 20	Mini-compressor connection.....	57
Fig. 21	Installing additional modules .....	61
Fig. 22	Types of power supply .....	65
Fig. 23	Reset input .....	66
Fig. 24	Control via supply with relay .....	67
Fig. 25	Control via the “Reset external” input .....	68
Fig. 26	Connection to zone detection .....	69
Fig. 27	Connection on selective identification or addressable loop.....	70
Fig. 28	Connection from XLM 35.....	70
Fig. 29	Connecting the OC outputs .....	71
Fig. 30	Connection of external temperature sensor.....	72
Fig. 31	Operation and display elements on the LMB 35 .....	77
Fig. 32	Configuration overview.....	77
Fig. 33	Workflow for commissioning using EasyConfig .....	80
Fig. 34	Workflow for commissioning with “ADW Config” configuration software .....	81
Fig. 35	View of the operation and display elements .....	96
Fig. 36	XLM 35 operation and display .....	108
Fig. 37	SIM 35 operation and display .....	108
Fig. 38	SMM 535 operation and display .....	109
Fig. 39	Removing LSU 35, LMB 35 and LEB 35.....	112
Fig. 40	Design of an RS485 ADW network.....	120
Fig. 41	Design of an Ethernet ADW network.....	121

## Document history

First edition      Date 19.06.2015

Index “a”      Date 15.12.2015

Most important changes compared with previous issue:

Section / Fig.		New (n) / changed (c) / deleted (d)	What / Reason
1.1 / 12.1 / 13	c / n	Application UL/ULC for ADW 535HDx and SIM 35 / SMM 535	Extension
1.3 / 1.5 / 4.1.1 / 13	c / n	Response behaviour according to EN 54-22, class A1I to GI	Extension
8.5.4.3	c	Event codes in event group <b>G06</b> corrected	Correction
Various	c	Various text corrections (SD memory card)	Correction

Index “b”      Date 31.10.2016

Most important changes compared with previous issue:

Section / Fig.		New (n) / changed (c) / deleted (d)	What / Reason
1.2 / 1.3 / 2.2.9 / 4.1.1 / 4.2 / 4.4.1 / 4.4.2 / 4.5 / 4.5.1 / 4.5.1.1 / 4.5.1.2 / 4.6 / 4.7.1 / 4.7.2 / 7.2 / 7.2.1 / 7.3.3 / 7.4 / 7.6.1 / 7.7.1 / 7.7.2 / 8.3 / 8.5.4.1 / 8.5.4.3 / 13 Fig. 3 / Fig. 9 / Fig. 14 / Fig. 32 / Fig. 33 / Fig. 34	c / n	Response behaviour expanded compliant with NFPA 72 / RVS / KFI New switch positions in <b>EasyConfig C &gt; No to T3</b>	Extension
2.2.12.2	c	Text supplement, triggering ext. temperature sensor	Rectification
2.2.21.3 / 7.3.5	c	Text supplement, initial reset when ADW housing is open	Addition
4.7.3 / 6.5.6 / 11.1 / 12.1	c / n	ART 535 for higher temperature range and EX	Addition
5.3	c	Temperature ranges of the sensing tube / supply line	Rectification
6.3 / 6.5.4.3	n	Notice about “EN 54-17” identification sign	Addition
7.1 / 7.3.5	n	Initial reset with sealing and length checks	Addition
7.1.1 / 11.2.2	n / c	New section “Connect via Ethernet”, additions under “ADW networking”	Addition
7.2.2	c	RIM relay assignment, adapted to “ADW Config”	Rectification
7.3.4 / 7.3.5 / 7.3.6 / 7.3.7 / 7.6.1 / 7.7.1 / 8.3 / 8.5.2	c / n	New switch positions <b>S</b> for the sensor activation	Correction / expansion
8.5.1	c	Text supplement “Sensing tube deactivated” when “Fault ½ s T” display	Addition
8.5.2 / 8.5.3.2	n	Explanation of status displays LED 1 to 7	Addition
8.5.3.2	n	New status displays “LST” (unsealed sensing tube)	Extension
8.5.4.2 / 8.5.4.3 / 10.3.1	n	New event code in event groups <b>G30 / G40</b> : <b>032</b> “Max. sensing tube length exceeded” <b>064</b> “Unsealed sensing tube”	Extension
8.5.4.3 / 10.3.1	c	Various text corrections	Rectification
13	c	Temperature range of the sensing tube	Rectification

## Document history

### Index “c”      Date 30.10.2018

Most important changes compared with previous issue:

Section / Fig.		New (n) / changed (c) / deleted (d)	What / Reason
2.2.9.1	c	Leakage test: monitoring window optimised	Correction
3.4	n	Support sleeve at the mounting set	Addition
4.8.2 / 13	c	RIM current consumption (all relays triggered)	Addition
5.3	c	Use of metal pipe clamps at 85°C and above	Correction
5.4.2.5	d	AD ADW Air accessories deleted	Correction
6.5.5	c	OC outputs short-circuit-proof	Supplemental text, correction
7.1.1 / 7.1.1.1 / 7.1.1.2 / 7.1.1.3 / 7.6.1 / 7.6.2 / 8.3 / 11.2.2	n / c	Extended IP address range, extended switch position <b>N</b> (factory setting IP address)	Extension
7.2.1	c	Expansion of the setting range of the diff alarm threshold (250 mbar/min)	Addition
7.3.4	c	Display at step (17) = Flashing - - - (approx. 2 x)	Correction
8.5.2	c	Indicators “Initial reset in progress” / “Test trigger active”	Addition
10.1	c	Procedure for defective units / replacement material	Supplemental text, correction
13	c	Name of standard for protection type/ambient conditions	Correction

### Index “d”      Date 01.02.2021

Most important changes compared with previous issue:

Section / Fig.		New (n) / changed (c) / deleted (d)	What / Reason
1.5 / 4.1.1 / 4.8 / 5.1 / 6 / 13	c	Corrections based on new ATEX standards EN 60079-0, EN 60079-7, EN 60079-15, EN 60079-31	Correction
Fig. 5 / 3.4 / 4.8 / 5.1 / Fig. 15 / 6 / 6.2 / Fig. 21 / Fig. 35 / Fig. 39	c	Only three cable screw unions included, all openings fitted with blind plugs	Correction / logistics